



To be sure – use SURE®

HITACHI

FILTERS SUB-CATALOG



SURE-US-HIT-VI-25



Table of Contents

ENGINE APPLICATION

A

PRODUCT GUIDE

B



ENGINE APPLICATION

A



Engine Application

MODEL/APPLICATION	SURE NO
-------------------	---------

HITACHI	
450 (EXCAVATORS) ISUZU 6BG1	Fuel Filter..... SFF 2564 Oil Filter Full Flow..... SFO 1638
CG100 (CRAWLER DUMPERS) HINO , 2006	Fuel Filter..... SFF 1010 Oil Filter By Pass..... SFO 1351 Oil Filter Full Flow..... SFO 4754
CH40-2 (CRAWLER DUMPERS) ISUZU C240	Fuel Filter..... SFF 0057 Fuel Filter..... SFF 0009
CX1100 (CRANES) ISUZU 6RB1T (S/N: 0503-UP)	Air Filter Secondary..... SFA 9373S Air Filter Primary..... SFA 1046P Fuel Filter..... SFF 2631 Hydraulic Oil Filter..... SFH 3321 Hydraulic Oil Filter..... SFH 4135 Oil Filter By Pass..... SFO 0163
CX400 (CRANES) HINO H07C-TD (S/N: 000101-UP)	Hydraulic Oil Filter..... SFH 4135 Hydraulic Oil Filter Suction..... SFH 0224 Hydraulic Oil Filter..... SFH 3321 Oil Filter By Pass..... SFO 0163
CX 500 (CRANES) HINO H07CT (S/N: 002003-UP)	Hydraulic Oil Filter..... SFH 4135 Hydraulic Oil Filter Suction..... SFH 0224 Hydraulic Oil Filter..... SFH 3321 Oil Filter By Pass..... SFO 0163
CX 500 (CRANES) HINO H07C-TD	Hydraulic Oil Filter..... SFH 65561
CX550-C (CRANES) HINO H07CT (S/N: 002141-UP)	Hydraulic Oil Filter Suction..... SFH 0224 Hydraulic Oil Filter..... SFH 4135 Hydraulic Oil Filter..... SFH 3321 Oil Filter By Pass..... SFO 0163
CX500S (CRANES) HINO H07CT (S/N: 002170-UP)	Hydraulic Oil Filter Suction..... SFH 0224 Hydraulic Oil Filter..... SFH 4135 Hydraulic Oil Filter..... SFH 3321 Oil Filter By Pass..... SFO 0163
CX700 (CRANES) HINO H07CT (S/N: 000101-UP)	Hydraulic Oil Filter Suction..... SFH 0224 Hydraulic Oil Filter..... SFH 4135 Hydraulic Oil Filter..... SFH 3321 Oil Filter By Pass..... SFO 0163

MODEL/APPLICATION	SURE NO
-------------------	---------

HITACHI	
CX700HD (CRANES) MITSUBISHI 6D24T (S/N: HCME 000101-UP)	Air Filter Primary..... SFA 1046P Air Filter Secondary..... SFA 9373S Hydraulic Oil Filter..... SFH 4135 Hydraulic Oil Filter..... SFH 3321
CX900 (CRANES) MITSUBISHI 6D24T (S/N: 000101-UP) , 2006	Air Filter Primary..... SFA 1046P Air Filter Secondary..... SFA 9373S Hydraulic Oil Filter..... SFH 4135 Hydraulic Oil Filter..... SFH 3321
CX900GLS (CRANES) MITSUBISHI 6D24-TC (S/N: 25DP000123-UP)	Air Filter Secondary..... SFA 9373S Air Filter Primary..... SFA 1046P Hydraulic Oil Filter..... SFH 4135 Hydraulic Oil Filter..... SFH 3321
CX900HD (CRANES) MITSUBISHI 6D24-TC (S/N: HCME 000101-UP)	Air Filter Secondary..... SFA 9373S Air Filter Primary..... SFA 1046P Hydraulic Oil Filter..... SFH 4135 Hydraulic Oil Filter..... SFH 3321
EG30 (CRAWLER DUMPERS) ISUZU 3LD2 PA01 , 2006	Air Filter Primary..... SFA 1575P Fuel Filter..... SFF 3560
EG70R (CRAWLER DUMPERS) ISUZU 6BG1T C-S (S/N: 010101-UP) , 2006	Air Filter Set..... SFA 6128SET Air Filter Primary..... SFA 61281P Air Filter Set..... SFA 61281SET Air Filter Primary..... SFA 6128P Fuel Filter..... SFF 0052
EG70R (CARRIERS) ISUZU 6BG1T	Fuel Filter..... SFF 2564
EG70R (CRAWLER DUMPERS) ISUZU CC-6BG1T	Hydraulic Oil Filter..... SFH 0403
EG70R (CRAWLER DUMPERS)	Air Filter Set..... SFA 61281SET Air Filter Set..... SFA 6128SET Air Filter Primary..... SFA 6128P Air Filter Primary..... SFA 61281P Fuel Filter..... SFF 0052
EH1000 (DUMP TRUCKS) CUMMINS QSK19	Air Filter Secondary..... SFA 8408S Air Filter Primary..... SFA 1042P Coolant Filter..... SFW 2074 Fuel/Water Separator..... SFR 1216FW

MODEL/APPLICATION	SURE NO
-------------------	---------

HITACHI	
EH1000 (DUMP TRUCKS) CUMMINS QSK19	Fuel/Water Separator..... SFR 5110FW Hydraulic Oil Filter..... SFH 0416 Oil Filter Combination..... SFO 2300
EH1100 (DUMP TRUCKS)	Air Filter Secondary..... SFA 0857S Fuel Filter..... SFF 5036 Fuel/Water Separator..... SFR 1216FW Oil Filter Full Flow..... SFO 7036
EH1100 423LD (DUMP TRUCKS)	Air Filter Secondary..... SFA 0857S Oil Filter Full Flow..... SFO 7036
EH1100-3 (DUMP TRUCKS) DETROIT DETROIT , 2008	Air Filter Secondary..... SFA 0857S
EH1100-3 (DUMP TRUCKS) w/MTU 2000 Series Eng. (Tier 2)	Fuel Filter..... SFF 0047
EH1600 (DUMP TRUCKS) CUMMINS QST30 SERIES	Air Filter Primary..... SFA 1042P Air Filter Secondary..... SFA 8408S Coolant Filter..... SFW 2075 Fuel/Water Separator..... SFR 3112FW Fuel/Water Separator..... SFR 1216FW
EH1600 (DUMP TRUCKS) CUMMINS QST30	Hydraulic Oil Filter Transmission... SFH 6135
EH1700 (DUMP TRUCKS) CUMMINS QST30	Cabin Air Filter..... SFC 30763 Hydraulic Oil Filter Transmission... SFH 6135
EH4500 (DUMP TRUCKS) w/Detroit Diesel 16V4000 Eng.	Fuel Filter..... SFF 0047
EH4000 (DUMP TRUCKS) w/Detroit Diesel 16V4000 Eng.	Fuel Filter..... SFF 0047
EH4500-2 (DUMP TRUCKS) DETROIT DIESEL 16V4000	Hydraulic Oil Filter..... SFH 6702
EH5000 (DUMP TRUCKS) w/Detroit Diesel 16V4000 Eng.	Fuel Filter..... SFF 0047
EH650 357TD (DUMP TRUCKS) VOLVO	Air Filter Set..... SFA 7871SET Air Filter Secondary..... SFA 7875S Air Filter Primary..... SFA 7871P Fuel Filter..... SFF 1723



To order, please call:
+1 8448 BE SURE; +1 (925) 566-8863

For Reference Only - May not be a direct cross

A 1



Email :
order@suresfilter.us



Engine Application

MODEL/APPLICATION	SURE NO
HITACHI	
EH650 357TD (DUMP TRUCKS) VOLVO Oil Filter By Pass..... SFO 2777 Oil Filter Full Flow..... SFO 0220	
EH700-2 (DUMP TRUCKS) CUMMINS QSX15 , 2004 Air Filter Primary..... SFA 1042P Air Filter Secondary..... SFA 8408S Hydraulic Oil Filter..... SFH 0416	
EH700-3 (DUMP TRUCKS) DETROIT 60 SERIES Air Filter Secondary..... SFA 0857S	
EH700-3 (DUMP TRUCKS) DETROIT SERIES 60 Hydraulic Oil Filter Transmission.. SFH 6135	
EH700-3 (DUMP TRUCKS) w/Detroit Diesel Series 60 Eng. Fuel Filter..... SFF 0047	
EH750-2 (DUMP TRUCKS) CUMMINS QSX15 , 2004 Air Filter Primary..... SFA 1042P Air Filter Secondary..... SFA 8408S Hydraulic Oil Filter..... SFH 0416	
EH750-3 (DUMP TRUCKS) DETROIT SERIES 60 , 2007 Coolant Filter..... SFW 2054 Coolant Filter..... SFW 2074	
EX1100-3 (EXCAVATORS) CUMMINS QSK19 Air Filter Secondary..... SFA 8408S Air Filter Primary..... SFA 1042P Coolant Filter..... SFW 2076 Coolant Filter..... SFW 2075 Fuel/Water Separator..... SFR 5110FW Hydraulic Oil Filter..... SFH 3321 Hydraulic Oil Filter Suction..... SFH 0224 Hydraulic Oil Filter..... SFH 7841 Oil Filter Combination..... SFO 2300	
EX1800-3 (EXCAVATORS) CUMMINS QSK19C Air Filter..... SFA 8172 Air Filter Secondary..... SFA 8408S Air Filter Primary..... SFA 1042P Coolant Filter..... SFW 2075 Coolant Filter..... SFW 2076 Fuel/Water Separator..... SFR 5110FW Hydraulic Oil Filter..... SFH 1334 Oil Filter Combination..... SFO 2300	
EX100 (EXCAVATORS) ISUZU 4BD1 , 1988 Air Filter Primary..... SFA 6099P Air Filter Secondary..... SFA 7975S Air Filter Set..... SFA 6099SET Fuel Filter..... SFF 6130 Hydraulic Oil Filter..... SFH 0987	

MODEL/APPLICATION	SURE NO
HITACHI	
EX100 (EXCAVATORS) ISUZU 4BD1 , 1988 Hydraulic Oil Filter..... SFH 7353 Hydraulic Oil Filter..... SFH 7841 Oil Filter Full Flow..... SFO 3853	
EX100 (EXCAVATORS) ISUZU 4BD1 Fuel Filter..... SFF 2564	
EX1000 (EXCAVATORS) HITACHI 6RB1T , 1988 Air Filter Secondary..... SFA 9373S Fuel Filter..... SFF 2631 Hydraulic Oil Filter..... SFH 7353 Oil Filter Full Flow..... SFO 0105	
EX100-2 (EXCAVATORS) ISUZU 4BD1 Air Filter Secondary..... SFA 7975S Air Filter Primary..... SFA 5623P Air Filter Set..... SFA 5623SET Fuel Filter..... SFF 2001 Fuel Filter..... SFF 2564 Hydraulic Oil Filter..... SFH 7353 Hydraulic Oil Filter..... SFH 5577 Hydraulic Oil Filter..... SFH 7841 Oil Filter Full Flow..... SFO 3853	
EX100-2 (EXCAVATORS) ISUZU 4BDL Air Filter Secondary..... SFA 7975S Air Filter Set..... SFA 5623SET Air Filter Primary..... SFA 5623P Fuel Filter..... SFF 2001 Hydraulic Oil Filter..... SFH 7841 Hydraulic Oil Filter..... SFH 7353 Oil Filter Full Flow..... SFO 3853	
EX100-3 (EXCAVATORS) ISUZU 4BD1 Fuel Filter..... SFF 2564 Hydraulic Oil Filter..... SFH 5577	
EX100-3 (EXCAVATORS) ISUZU 4BG1 Fuel Filter..... SFF 0057	
EX100-5 (EXCAVATORS) ISUZU 4BG1 Air Filter Secondary..... SFA 7975S Air Filter Set..... SFA 5623SET Air Filter Primary..... SFA 5623P Fuel Filter..... SFF 0057 Fuel Filter..... SFF 6280 Fuel Filter..... SFF 2001 Hydraulic Oil Filter..... SFH 5577 Hydraulic Oil Filter..... SFH 7353 Hydraulic Oil Filter..... SFH 7841 Oil Filter Full Flow..... SFO 3853	
EX100M-2 (EXCAVATORS) ISUZU 4BD1 Hydraulic Oil Filter..... SFH 5577	

MODEL/APPLICATION	SURE NO
HITACHI	
EX100M-2 (EXCAVATORS) ISUZU 4BD1 Hydraulic Oil Filter..... SFH 5577	
EX100M-3 (EXCAVATORS) ISUZU 4BD1 Hydraulic Oil Filter..... SFH 5577	
EX100M-5 (EXCAVATORS) ISUZU 4BG1 Fuel Filter..... SFF 0057 Hydraulic Oil Filter..... SFH 5577	
EX1100 (EXCAVATORS) HITACHI KTTA19C Air Filter Secondary..... SFA 8408S Air Filter Primary..... SFA 1042P Coolant Filter..... SFW 2075 Fuel Filter..... SFF 0105D Hydraulic Oil Filter..... SFH 7841 Hydraulic Oil Filter Suction..... SFH 0224 Oil Filter Full Flow..... SFO 2670 Oil Filter By Pass..... SFO 2777	
EX12 (EXCAVATORS) ISUZU 3KC1 , 1990 Fuel Filter..... SFF 3425 Hydraulic Oil Filter..... SFH 4130 Hydraulic Oil Filter..... SFH 0010 Oil Filter Full Flow..... SFO 4302	
EX120 (EXCAVATORS) ISUZU 4BD1T , 1988 Air Filter Secondary..... SFA 8238S Air Filter Set..... SFA 6099SET Air Filter Primary..... SFA 6099P Air Filter Primary..... SFA 6098P Air Filter Set..... SFA 6098SET Fuel Filter..... SFF 6130 Hydraulic Oil Filter..... SFH 0987 Hydraulic Oil Filter..... SFH 7841 Hydraulic Oil Filter..... SFH 7353 Oil Filter Full Flow..... SFO 3853	
EX120 (EXCAVATORS) ISUZU 4BD1T Fuel Filter..... SFF 2564	
EX1200-5 (EXCAVATORS) ISUZU 4BG1T Hydraulic Oil Filter..... SFH 5577	
EX1200-5 (EXCAVATORS) MITSUBISHI S6R-Y1TAA1 Air Filter Set..... SFA 2180SET Air Filter Secondary..... SFA 2320S Air Filter Primary..... SFA 2180P Fuel Filter..... SFF 9013 Fuel/Water Separator Primary..... SFR 2130FW Hydraulic Oil Filter..... SFH 3321 Hydraulic Oil Filter..... SFH 7634 Hydraulic Oil Filter..... SFH 7841 Hydraulic Oil Filter Suction..... SFH 0224	



To order, please call:
+1 8448 BE SURE; +1 (925) 566-8863

For Reference Only - May not be a direct cross

A 2



Email :
order@suresfilter.us



Engine Application

MODEL/APPLICATION	SURE NO
HITACHI	

EX1200-5 (EXCAVATORS) MITSUBISHI S6R-Y1TAA1	Oil Filter By Pass..... SFO 2777
EX1200-5 (EXCAVATORS) MITSUBISHI S6R-Y1T	Cabin Air Filter..... SFC 50249 Fuel Filter..... SFF 6030
EX1200-5 (EXCAVATORS) W/MITSUBISHI S6R-Y1T ENG.	Cabin Air Filter..... SFC 00684
EX1200-5C (EXCAVATORS) MITSUBISHI S6R-Y1TAA1	Air Filter Secondary..... SFA 2320S Air Filter Primary..... SFA 2180P Air Filter Set..... SFA 2180SET Fuel Filter..... SFF 9013 Hydraulic Oil Filter..... SFH 7634 Hydraulic Oil Filter Suction..... SFH 0224 Hydraulic Oil Filter..... SFH 3321 Hydraulic Oil Filter..... SFH 7841 Oil Filter By Pass..... SFO 5400 Oil Filter By Pass..... SFO 2777
EX1200-5C (EXCAVATORS) MITSUBISHI S6R-Y1T	Cabin Air Filter..... SFC 50249 Fuel Filter..... SFF 6030
EX1200-5C (EXCAVATORS) W/MITSUBISHI S6R-Y1T ENG.	Cabin Air Filter..... SFC 00684
EX120-2 (EXCAVATORS) ISUZU 4BD1T	Air Filter Secondary..... SFA 8238S Fuel Filter..... SFF 6280 Fuel Filter..... SFF 2001 Fuel Filter..... SFF 0057 Fuel Filter..... SFF 2564 Hydraulic Oil Filter..... SFH 7353 Hydraulic Oil Filter..... SFH 7841 Oil Filter Full Flow..... SFO 1638 Oil Filter By Pass..... SFO 2692 Oil Filter Full Flow..... SFO 3853
EX120-5 (EXCAVATORS) ISUZU 4BG1T	Air Filter Secondary..... SFA 8238S Cabin Air Filter..... SFC 50249 Fuel Filter..... SFF 0057 Fuel Filter..... SFF 6280 Fuel Filter..... SFF 2001 Hydraulic Oil Filter..... SFH 7841 Hydraulic Oil Filter..... SFH 7353 Oil Filter By Pass..... SFO 2692 Oil Filter Full Flow..... SFO 3853 Oil Filter Full Flow..... SFO 1638
EX15 (EXCAVATORS) ISUZU 3KC1 , 1990	Fuel Filter..... SFF 1045 Hydraulic Oil Filter..... SFH 0010 Hydraulic Oil Filter..... SFH 4130 Oil Filter Full Flow..... SFO 4302

MODEL/APPLICATION	SURE NO
HITACHI	

EX15 (EXCAVATORS) ISUZU 3KC1 , 1990	Fuel Filter..... SFF 1045 Hydraulic Oil Filter..... SFH 0010 Hydraulic Oil Filter..... SFH 4130 Oil Filter Full Flow..... SFO 4302
EX150 (EXCAVATORS) HITACHI 4BD1T , 1988	Air Filter Primary..... SFA 6098P Air Filter Secondary..... SFA 8238S Air Filter Set..... SFA 6098SET Fuel Filter..... SFF 6130 Hydraulic Oil Filter..... SFH 0987 Hydraulic Oil Filter..... SFH 7841 Hydraulic Oil Filter..... SFH 7353 Oil Filter Full Flow..... SFO 3853
EX150-5 (EXCAVATORS) ISUZU 4BG1T	Fuel Filter..... SFF 2001 Hydraulic Oil Filter..... SFH 7353 Hydraulic Oil Filter..... SFH 7841 Hydraulic Oil Filter..... SFH 7841 Hydraulic Oil Filter..... SFH 5577 Oil Filter By Pass..... SFO 2692 Oil Filter Full Flow..... SFO 3853
EX15-2 (EXCAVATORS) KUBOTA D1105-B	Hydraulic Oil Filter..... SFH 0010 Hydraulic Oil Filter..... SFH 4130
EX16-2B (EXCAVATORS) KUBOTA D1105-B	Fuel Filter..... SFF 3560 Hydraulic Oil Filter..... SFH 4130 Hydraulic Oil Filter..... SFH 0010
EX17-2 (EXCAVATORS) KUBOTA D1105-B	Fuel Filter..... SFF 3560 Hydraulic Oil Filter..... SFH 4130 Hydraulic Oil Filter..... SFH 0010
EX17-2B (EXCAVATORS) KUBOTA D1105-B	Hydraulic Oil Filter..... SFH 0010 Hydraulic Oil Filter..... SFH 4130
EX1800 (EXCAVATORS) CUMMINS KTA-19C	Air Filter Secondary..... SFA 8408S Air Filter Primary..... SFA 1042P Air Filter..... SFA 8172 Coolant Filter..... SFW 2071 Coolant Filter..... SFW 2075 Fuel Filter..... SFF 0105D Hydraulic Oil Filter..... SFH 5299 Hydraulic Oil Filter..... SFH 1334 Oil Filter By Pass..... SFO 2777 Oil Filter Full Flow..... SFO 2670

MODEL/APPLICATION	SURE NO
HITACHI	

EX1900-5 (EXCAVATORS) MITSUBISHI S12A2-YTAA1	Air Filter Primary..... SFA 1042P Air Filter..... SFA 8172 Air Filter Secondary..... SFA 8408S Fuel Filter..... SFF 9013 Fuel/Water Separator Primary..... SFR 2130FW Hydraulic Oil Filter..... SFH 7634 Hydraulic Oil Filter..... SFH 0542 Oil Filter By Pass..... SFO 2777
EX100WD (EXCAVATORS) ISUZU 6BB1	Air Filter Secondary..... SFA 8238S Air Filter Primary..... SFA 6098P Air Filter Set..... SFA 6098SET Fuel Filter..... SFF 0052 Fuel Filter..... SFF 2564 Hydraulic Oil Filter..... SFH 0987 Hydraulic Oil Filter..... SFH 7353 Hydraulic Oil Filter..... SFH 7841 Oil Filter..... SFO 6081 Oil Filter Full Flow..... SFO 9726 Oil Filter Full Flow..... SFO 1638
EX100WD (EXCAVATORS) ISUZU 6BBL	Air Filter Primary..... SFA 6098P Air Filter Set..... SFA 6098SET Air Filter Secondary..... SFA 8238S Fuel Filter..... SFF 0052 Hydraulic Oil Filter..... SFH 7841 Hydraulic Oil Filter..... SFH 0987 Hydraulic Oil Filter..... SFH 7353
EX100WD-2 (EXCAVATORS) ISUZU 4BD1T	Air Filter Secondary..... SFA 8238S Fuel Filter..... SFF 0057 Fuel Filter..... SFF 2001 Hydraulic Oil Filter..... SFH 7841 Hydraulic Oil Filter..... SFH 5577 Hydraulic Oil Filter..... SFH 7353 Oil Filter Full Flow..... SFO 1638 Oil Filter Full Flow..... SFO 3853 Oil Filter By Pass..... SFO 2692
EX100WD-3 (EXCAVATORS) ISUZU	Air Filter Secondary..... SFA 8238S Fuel Filter..... SFF 0052 Fuel Filter..... SFF 2001 Hydraulic Oil Filter..... SFH 7841 Hydraulic Oil Filter..... SFH 7353 Oil Filter Full Flow..... SFO 3853 Oil Filter By Pass..... SFO 2692
EX100WD-3 (EXCAVATORS) ISUZU 4BD1T	Fuel Filter..... SFF 0057 Fuel Filter..... SFF 2564



To order, please call:
+1 8448 BE SURE; +1 (925) 566-8863

For Reference Only - May not be a direct cross

A 3



Email :
order@suresfilter.us



Engine Application

MODEL/APPLICATION	SURE NO
-------------------	---------

HITACHI	
EX100WD-3 (EXCAVATORS) ISUZU 4BD1T	Hydraulic Oil Filter..... SFH 5577 Oil Filter Full Flow..... SFO 1638
EX1200-5D (EXCAVATORS) CUMMINS QSK23 (S/N: 003001-UP)	Air Filter Primary..... SFA 2180P Air Filter Secondary..... SFA 2320S Air Filter Set..... SFA 2180SET Coolant Filter..... SFW 2076 Fuel/Water Separator..... SFR 3112FW Hydraulic Oil Filter..... SFH 7634 Hydraulic Oil Filter..... SFH 7841 Hydraulic Oil Filter..... SFH 3321 Hydraulic Oil Filter Suction..... SFH 0224 Oil Filter Full Flow..... SFO 2670
EX1200BE (EXCAVATORS)	Air Filter Primary..... SFA 2180P Air Filter Secondary..... SFA 2320S Air Filter Set..... SFA 2180SET Fuel Filter..... SFF 9013 Hydraulic Oil Filter..... SFH 7634 Hydraulic Oil Filter Suction..... SFH 0224 Hydraulic Oil Filter..... SFH 3321 Hydraulic Oil Filter..... SFH 7841
EX122 (EXCAVATORS)	Air Filter Primary..... SFA 0418P Fuel Filter..... SFF 0027 Oil Filter Full Flow..... SFO 3265
EX130 (EXCAVATORS) KUBOTA	Hydraulic Oil Filter..... SFH 4135
EX130H-5 (EXCAVATORS) ISUZU 4BG1T	Cabin Air Filter..... SFC 50249 Fuel Filter..... SFF 6280 Fuel Filter..... SFF 2001 Hydraulic Oil Filter..... SFH 7353 Hydraulic Oil Filter..... SFH 5577 Hydraulic Oil Filter..... SFH 7841 Oil Filter By Pass..... SFO 2692 Oil Filter Full Flow..... SFO 3853
EX135 (EXCAVATORS)	Fuel Filter..... SFF 3291 Hydraulic Oil Filter..... SFH 7353 Hydraulic Oil Filter..... SFH 7841
EX135UR (EXCAVATORS) ISUZU 4BG1	Air Filter Set..... SFA 88891SET Air Filter Primary..... SFA 8889P Air Filter Primary..... SFA 88891P Air Filter Primary..... SFA 77251P

MODEL/APPLICATION	SURE NO
-------------------	---------

HITACHI	
EX135UR (EXCAVATORS) ISUZU 4BG1	Fuel Filter..... SFF 2001 Hydraulic Oil Filter..... SFH 7841 Hydraulic Oil Filter..... SFH 5577 Hydraulic Oil Filter..... SFH 7353 Oil Filter Full Flow..... SFO 3853 Oil Filter By Pass..... SFO 2692
EX160WD (EXCAVATORS) ISUZU 6BB1	Air Filter Secondary..... SFA 8238S Air Filter Set..... SFA 6098SET Air Filter Primary..... SFA 6098P Fuel Filter..... SFF 0052 Fuel Filter..... SFF 2564 Hydraulic Oil Filter Suction..... SFH 0224 Hydraulic Oil Filter..... SFH 7841
EX165 (EXCAVATORS) ISUZU 4BG1	Air Filter Secondary..... SFA 8238S Fuel Filter..... SFF 2001 Hydraulic Oil Filter..... SFH 7353 Hydraulic Oil Filter..... SFH 7841 Hydraulic Oil Filter Suction..... SFH 0224 Oil Filter Full Flow..... SFO 3853
EX165 (EXCAVATORS)	Air Filter Secondary..... SFA 8238S Fuel Filter..... SFF 2001 Hydraulic Oil Filter..... SFH 7841 Hydraulic Oil Filter..... SFH 7353 Oil Filter Full Flow..... SFO 3853 Oil Filter By Pass..... SFO 2692
EX165W (EXCAVATORS) CUMMINS 6BT5.9	Cabin Air Filter..... SFC 50249
EX165W (EXCAVATORS) CUMMINS 6BT5.9-C	Air Filter Primary..... SFA 4905P Air Filter Secondary..... SFA 4589S Fuel Filter Secondary..... SFF 5052 Fuel/Water Separator..... SFR 1280FW Hydraulic Oil Filter..... SFH 7353 Oil Filter Full Flow..... SFO 3349
EX150-1 (EXCAVATORS) ISUZU 4BG1T	Fuel Filter..... SFF 0057
EX100W (EXCAVATORS) ISUZU 6BB1	Fuel Filter..... SFF 2564 Oil Filter Full Flow..... SFO 1638
EX120-3 (EXCAVATORS) ISUZU 4BD1T	Fuel Filter..... SFF 2564 Oil Filter Full Flow..... SFO 1638

MODEL/APPLICATION	SURE NO
-------------------	---------

HITACHI	
EX22 (EXCAVATORS) ISUZU 3KR1 , 1990	Air Filter Set..... SFA 4723SET Air Filter Primary..... SFA 4723PF Fuel Filter..... SFF 3425 Fuel Filter..... SFF 3560 Hydraulic Oil Filter..... SFH 4135 Oil Filter Full Flow..... SFO 4302
EX22 (EXCAVATORS) ISUZU 3KR1	Hydraulic Oil Filter..... SFH 4132
EX22 (EXCAVATORS) KUBOTA D1105E	Hydraulic Oil Filter..... SFH 4132
EX200 (EXCAVATORS) HITACHI 6BD1T , 1988	Air Filter Primary..... SFA 3113P Air Filter Secondary..... SFA 9373S Air Filter Secondary..... SFA 0490S Air Filter Set..... SFA 6050SET Fuel Filter..... SFF 0052 Hydraulic Oil Filter Suction..... SFH 0224 Hydraulic Oil Filter..... SFH 7841 Oil Filter By Pass..... SFO 3601
EX200 (EXCAVATORS) ISUZU 4BD1	Fuel Filter..... SFF 2564
EX200 (EXCAVATORS) ISUZU 6BD1	Fuel Filter..... SFF 2564 Oil Filter Full Flow..... SFO 1638
EX200 (EXCAVATORS) ISUZU 6BD1T	Fuel Filter..... SFF 2564 Oil Filter Full Flow..... SFO 1638 Oil Filter By Pass..... SFO 1195
EX200 (EXCAVATORS) ISUZU 6B1T	Fuel Filter..... SFF 2564 Oil Filter Full Flow..... SFO 1638
EX200-2 (EXCAVATORS) ISUZU 6BD1	Air Filter Secondary..... SFA 1908S Air Filter Primary..... SFA 3861P Fuel Filter..... SFF 0052 Fuel Filter..... SFF 2564 Hydraulic Oil Filter Suction..... SFH 0224 Hydraulic Oil Filter..... SFH 7841 Oil Filter By Pass..... SFO 0163
EX200-2 (EXCAVATORS) ISUZU 6BD1T	Fuel Filter..... SFF 2564 Oil Filter Full Flow..... SFO 1638



To order, please call:
+1 8448 BE SURE; +1 (925) 566-8863

For Reference Only - May not be a direct cross



Email :
order@suresfilter.us



Engine Application

MODEL/APPLICATION	SURE NO
HITACHI	
EX200-3 (EXCAVATORS) ISUZU 6BD1	
Fuel Filter.....	SFF 2564
Oil Filter Full Flow.....	SFO 1638
EX200-3 (EXCAVATORS) ISUZU 6BD1T	
Fuel Filter.....	SFF 2564
Oil Filter Full Flow.....	SFO 1638
EX200-5 (EXCAVATORS) ISUZU 6BG1	
Air Filter Primary.....	SFA 61281P
Air Filter Primary.....	SFA 6128P
Air Filter Set.....	SFA 61281SET
Air Filter Set.....	SFA 6128SET
Air Filter Secondary.....	SFA 6130S
Cabin Air Filter.....	SFC 50249
Fuel Filter.....	SFF 0052
Fuel Filter.....	SFF 2564
Fuel Filter.....	SFF 6280
Hydraulic Oil Filter Suction.....	SFH 0224
Hydraulic Oil Filter.....	SFH 7841
Oil Filter By Pass.....	SFO 0163
Oil Filter Full Flow.....	SFO 1638
EX200-5 (EXCAVATORS) ISUZU A-6BG1T	
Oil Filter.....	SFO 6081
Oil Filter Full Flow.....	SFO 9726
EX200LC (EXCAVATORS)	
Air Filter Primary.....	SFA 3861P
Air Filter Secondary.....	SFA 1908S
EX200LC-5 (EXCAVATORS) ISUZU 6BG1T	
Fuel Filter.....	SFF 2564
EX200LC-5 (EXCAVATORS) ISUZU 6BG1	
Cabin Air Filter.....	SFC 50249
Fuel Filter.....	SFF 2564
Oil Filter.....	SFO 6081
Oil Filter Full Flow.....	SFO 9726
EX220 (EXCAVATORS) HITACHI H06C-T	
Air Filter Primary.....	SFA 1080P
Air Filter Secondary.....	SFA 7315S
Air Filter Set.....	SFA 9025SET
Fuel Filter.....	SFF 0052
Hydraulic Oil Filter Suction.....	SFH 0224
Hydraulic Oil Filter.....	SFH 7841
Oil Filter By Pass.....	SFO 8241
EX220-2 (EXCAVATORS) HINO H06C-T	
Hydraulic Oil Filter.....	SFH 6705
EX220-2 (EXCAVATORS) HITACHI H06C-T	

MODEL/APPLICATION	SURE NO
HITACHI	
EX220-2 (EXCAVATORS) HITACHI H06C-T	
Air Filter Primary.....	SFA 61281P
Air Filter Set.....	SFA 61281SET
Air Filter Set.....	SFA 6128SET
Air Filter Primary.....	SFA 6128P
Air Filter Secondary.....	SFA 6130S
Hydraulic Oil Filter Suction.....	SFH 0224
Hydraulic Oil Filter.....	SFH 7841
Oil Filter Combination.....	SFO 0600
Oil Filter By Pass.....	SFO 0163
EX220-5 (EXCAVATORS) HINO H07C-TD	
Air Filter Set.....	SFA 6128SET
Air Filter Primary.....	SFA 6128P
Air Filter Primary.....	SFA 61281P
Air Filter Set.....	SFA 61281SET
Air Filter Secondary.....	SFA 6130S
Cabin Air Filter.....	SFC 50249
Fuel Filter.....	SFF 6280
Hydraulic Oil Filter Suction.....	SFH 0224
Hydraulic Oil Filter.....	SFH 7841
Oil Filter By Pass.....	SFO 0163
Oil Filter Combination.....	SFO 0600
EX220-5 (EXCAVATORS) HINO H07CT	
Hydraulic Oil Filter.....	SFH 6705
EX22-2 (EXCAVATORS) KUBOTA D1105	
Hydraulic Oil Filter.....	SFH 4132
EX22-2 (EXCAVATORS) KUBOTA D1105-B	
Air Filter Primary.....	SFA 4723PF
Air Filter Set.....	SFA 4723SET
Fuel Filter.....	SFF 3560
Hydraulic Oil Filter.....	SFH 4130
Hydraulic Oil Filter.....	SFH 4132
EX22-2 (EXCAVATORS) KUBOTA D905E	
Hydraulic Oil Filter.....	SFH 4132
EX2500 (EXCAVATORS) CUMMINS KTA50	
Hydraulic Oil Filter.....	SFH 0542
EX2500 (EXCAVATORS) CUMMINS KTA25C	
Air Filter Secondary.....	SFA 0857S
Air Filter.....	SFA 8172
Coolant Filter.....	SFW 2074
Fuel/Water Separator.....	SFR 1216FW
Hydraulic Oil Filter.....	SFH 5299
Hydraulic Oil Filter.....	SFH 7634
Oil Filter By Pass.....	SFO 2777
Oil Filter Full Flow.....	SFO 2670
EX25-2 (EXCAVATORS) KUBOTA D1105-B	

MODEL/APPLICATION	SURE NO
HITACHI	
EX25-2 (EXCAVATORS) KUBOTA D1105-B	
Air Filter Set.....	SFA 4723SET
Air Filter Primary.....	SFA 4723PF
Fuel Filter.....	SFF 3560
Hydraulic Oil Filter.....	SFH 4132
Hydraulic Oil Filter.....	SFH 4130
EX255 (EXCAVATORS) CUMMINS	
Air Filter Set.....	SFA 1531SET
Air Filter Secondary.....	SFA 0678S
Air Filter Primary.....	SFA 1531PF
Coolant Filter.....	SFW 2076
Coolant Filter.....	SFW 2075
Fuel Filter Secondary.....	SFF 5052
Fuel Filter.....	SFS 5079
Fuel/Water Separator.....	SFR 1280FW
Hydraulic Oil Filter.....	SFH 7841
Hydraulic Oil Filter Suction.....	SFH 0224
EX255 (EXCAVATORS) CUMMINS 6CT8.3	
Hydraulic Oil Filter.....	SFH 6705
EX255 (EXCAVATORS) ISUZU 6BG1T	
Air Filter Secondary.....	SFA 6130S
Air Filter Primary.....	SFA 6128P
Air Filter Set.....	SFA 6128SET
Air Filter Primary.....	SFA 61281P
Air Filter Set.....	SFA 61281SET
Fuel Filter.....	SFF 0052
Fuel Filter.....	SFF 2564
Hydraulic Oil Filter Suction.....	SFH 0224
Hydraulic Oil Filter.....	SFH 7841
Oil Filter By Pass.....	SFO 0163
EX255 (EXCAVATORS) ISUZU 6BG1	
Fuel Filter.....	SFF 2564
EX270 (EXCAVATORS) CUMMINS	
Air Filter Primary.....	SFA 1531PF
Air Filter Set.....	SFA 1531SET
Air Filter Secondary.....	SFA 0678S
Fuel Filter Secondary.....	SFF 5052
Fuel/Water Separator.....	SFR 1280FW
Hydraulic Oil Filter.....	SFH 7841
Oil Filter Combination.....	SFO 2300
EX270 (EXCAVATORS) HINO H06C-T	
Fuel Filter.....	SFF 2564
EX270 (EXCAVATORS) HITACHI H06C-T	
Air Filter Primary.....	SFA 1080P
Air Filter Secondary.....	SFA 7315S
Air Filter Set.....	SFA 9025SET
Hydraulic Oil Filter Suction.....	SFH 0224



To order, please call:
+1 8448 BE SURE; +1 (925) 566-8863

For Reference Only - May not be a direct cross



Email :
order@suresfilter.us



Engine Application

MODEL/APPLICATION	SURE NO
-------------------	---------

HITACHI	
EX270 (EXCAVATORS) HITACHI H06C-T	Hydraulic Oil Filter..... SFH 7841 Oil Filter By Pass..... SFO 8241
EX27U (EXCAVATORS) ISUZU 3LD1	Air Filter Primary..... SFA 1575P Hydraulic Oil Filter..... SFH 4130
EX29UE (EXCAVATORS) ISUZU 3LD1	Air Filter Primary..... SFA 1575P Hydraulic Oil Filter..... SFH 4130 Hydraulic Oil Filter..... SFH 0403
EX2500-5 (EXCAVATORS) CUMMINS QSK45	Hydraulic Oil Filter..... SFH 0542
EX210H-5 (EXCAVATORS) ISUZU 6BG1	Air Filter Primary..... SFA 6128P Air Filter Set..... SFA 6128SET Air Filter Primary..... SFA 61281P Air Filter Set..... SFA 61281SET Air Filter Secondary..... SFA 6130S Cabin Air Filter..... SFC 50249 Fuel Filter..... SFF 0052 Fuel Filter..... SFF 2564 Hydraulic Oil Filter..... SFH 7841 Hydraulic Oil Filter Suction..... SFH 0224 Oil Filter By Pass..... SFO 0163
EX215 (EXCAVATORS) IVECO	Air Filter Primary..... SFA 1555PF Air Filter Secondary..... SFA 4589S Air Filter Set..... SFA 1555SET Fuel Filter..... SFF 7240 Hydraulic Oil Filter Suction..... SFH 0224 Hydraulic Oil Filter..... SFH 7841 Oil Filter Combination..... SFO 3628
EX225USR (EXCAVATORS) ISUZU 6BG1T	Air Filter Primary..... SFA 61281P Air Filter Set..... SFA 61281SET Air Filter Primary..... SFA 6128P Air Filter Set..... SFA 6128SET Air Filter Secondary..... SFA 6130S Fuel Filter..... SFF 0052 Hydraulic Oil Filter..... SFH 7841 Hydraulic Oil Filter Suction..... SFH 0224 Oil Filter By Pass..... SFO 0163
EX225USR (EXCAVATORS) ISUZU 6BG1	Fuel Filter..... SFF 2564
EX230LC-5 (EXCAVATORS) HINO H07C-TD	Air Filter Set..... SFA 6128SET

MODEL/APPLICATION	SURE NO
-------------------	---------

HITACHI	
EX230LC-5 (EXCAVATORS) HINO H07C-TD	Air Filter Primary..... SFA 6128P Air Filter Primary..... SFA 61281P Air Filter Set..... SFA 61281SET Air Filter Secondary..... SFA 6130S Fuel Filter..... SFF 6280 Hydraulic Oil Filter Suction..... SFH 0224 Hydraulic Oil Filter..... SFH 7841 Oil Filter By Pass..... SFO 0163 Oil Filter Combination..... SFO 0600
EX235 (EXCAVATORS)	Air Filter Set..... SFA 1555SET Air Filter Primary..... SFA 1555PF Air Filter Secondary..... SFA 4589S Fuel Filter..... SFF 7240 Hydraulic Oil Filter..... SFH 7841 Oil Filter Combination..... SFO 3628
EX285 (EXCAVATORS) CUMMINS	Air Filter Primary..... SFA 1531PF Air Filter Set..... SFA 1531SET Air Filter Secondary..... SFA 0678S Coolant Filter..... SFW 2076 Coolant Filter..... SFW 2075 Fuel Filter Secondary..... SFF 5052 Fuel/Water Separator..... SFR 1280FW Hydraulic Oil Filter..... SFH 7841 Hydraulic Oil Filter Suction..... SFH 0224
EX285 (EXCAVATORS) CUMMINS 6CT8.3	Cabin Air Filter..... SFC 50249
EX285 (EXCAVATORS) ISUZU 6BG1T	Fuel Filter..... SFF 2564
EX285 (EXCAVATORS) ISUZU 6BG1	Fuel Filter..... SFF 2564 Hydraulic Oil Filter..... SFH 6705
EX285 (EXCAVATORS) ISUZU 6BG1-TRA06 (S/N: TIER 2-UP)	Air Filter Primary..... SFA 6128P Air Filter Primary..... SFA 61281P Air Filter Set..... SFA 6128SET Air Filter Set..... SFA 61281SET Air Filter Secondary..... SFA 6130S Fuel Filter..... SFF 0052 Hydraulic Oil Filter Suction..... SFH 0224 Hydraulic Oil Filter..... SFH 7841 Oil Filter By Pass..... SFO 0163
EX29U (EXCAVATORS)	Air Filter Primary..... SFA 1575P Fuel Filter..... SFF 3560

MODEL/APPLICATION	SURE NO
-------------------	---------

HITACHI	
EX29U (EXCAVATORS)	Hydraulic Oil Filter..... SFH 4130
EX210LCH-5 (EXCAVATORS) ISUZU 6BG1	Cabin Air Filter..... SFC 50249 Fuel Filter..... SFF 2564 Oil Filter..... SFO 6081 Oil Filter Full Flow..... SFO 9726
EX200-1 (EXCAVATORS) ISUZU 6BD1T	Fuel Filter..... SFF 2564 Oil Filter Full Flow..... SFO 1638 Oil Filter By Pass..... SFO 1195
EX210LC-5 (EXCAVATORS) ISUZU 6BG1	Fuel Filter..... SFF 2564
EX35 (EXCAVATORS) ISUZU 3KR2 , 1991	Air Filter Set..... SFA 4723SET Air Filter Primary..... SFA 4723PF Fuel Filter..... SFF 3425 Fuel Filter..... SFF 3560 Hydraulic Oil Filter..... SFH 4135 Oil Filter Full Flow..... SFO 4302
EX35 (EXCAVATORS) ISUZU 3KR2	Hydraulic Oil Filter..... SFH 4132
EX355 - TIER 2 (EXCAVATORS) ISUZU 6HK1-XQA01	Air Filter Primary..... SFA 0022PF Air Filter Set..... SFA 0022SET
EX30 (EXCAVATORS) ISUZU 3KR2	Hydraulic Oil Filter..... SFH 4132
EX30 (EXCAVATORS) ISUZU 3KR2 (S/N: HA03-UP)	Air Filter Primary..... SFA 4723PF Air Filter Set..... SFA 4723SET Fuel Filter..... SFF 3425 Fuel Filter..... SFF 3560 Hydraulic Oil Filter..... SFH 4135 Oil Filter Full Flow..... SFO 4302
EX300-2 (EXCAVATORS) ISUZU 6SD1T	Air Filter Set..... SFA 6070SET Air Filter Primary..... SFA 31302P Air Filter Primary..... SFA 3130P Air Filter Secondary..... SFA 7599S Fuel Filter..... SFF 2564 Fuel Filter..... SFF 2631 Fuel Filter..... SFF 0052 Fuel Filter..... SFF 6280 Hydraulic Oil Filter Suction..... SFH 0224 Hydraulic Oil Filter..... SFH 7841



To order, please call:
+1 8448 BE SURE; +1 (925) 566-8863

For Reference Only - May not be a direct cross



Email :
order@suresfilter.us



Engine Application

MODEL/APPLICATION	SURE NO
-------------------	---------

HITACHI	
EX300-2 (EXCAVATORS) ISUZU 6SD1T	
Oil Filter Full Flow.....	SFO 6007
Oil Filter By Pass.....	SFO 0163
EX300-3 (EXCAVATORS) ISUZU 6SD1T	
Air Filter Secondary.....	SFA 7599S
Air Filter Primary.....	SFA 3130P
Air Filter Set.....	SFA 6070SET
Air Filter Primary.....	SFA 31302P
Fuel Filter.....	SFF 6280
Fuel Filter.....	SFF 2631
Hydraulic Oil Filter.....	SFH 7841
Hydraulic Oil Filter Suction.....	SFH 0224
Oil Filter Full Flow.....	SFO 6007
Oil Filter By Pass.....	SFO 0163
EX300-5 (EXCAVATORS)	
Air Filter Secondary.....	SFA 9591S
Air Filter Primary.....	SFA 2214P
Air Filter Set.....	SFA 2214SET
Fuel Filter.....	SFF 6280
Fuel Filter.....	SFF 2631
Hydraulic Oil Filter.....	SFH 7841
Oil Filter Full Flow.....	SFO 6007
Oil Filter By Pass.....	SFO 0163
EX300-LC (EXCAVATORS) , 1993	
Air Filter Primary.....	SFA 2530P
Air Filter Secondary.....	SFA 4046S
Air Filter Set.....	SFA 8600SET
Fuel Filter.....	SFF 105N
Hydraulic Oil Filter.....	SFH 7841
Oil Filter By Pass.....	SFO 8241
EX30-2 (EXCAVATORS) KUBOTA V1505 , 1992	
Air Filter Primary.....	SFA 4723PF
Air Filter Set.....	SFA 4723SET
Fuel Filter.....	SFF 3560
Hydraulic Oil Filter.....	SFH 4130
EX30-2 (EXCAVATORS) ISUZU 3K1C1	
Hydraulic Oil Filter.....	SFH 4132
EX30-2 (EXCAVATORS) KUBOTA V1505	
Hydraulic Oil Filter.....	SFH 4132
EX30U (EXCAVATORS) ISUZU 3LD1	
Air Filter Primary.....	SFA 1575P
Fuel Filter.....	SFF 3560
Hydraulic Oil Filter.....	SFH 0403
Hydraulic Oil Filter.....	SFH 4130
EX32UE (EXCAVATORS) ISUZU 3LD1 , 2003	
Air Filter Primary.....	SFA 1575P

MODEL/APPLICATION	SURE NO
-------------------	---------

HITACHI	
EX32UE (EXCAVATORS) ISUZU 3LD1 , 2003	
Fuel Filter.....	SFF 3560
Hydraulic Oil Filter.....	SFH 4130
EX32UE (EXCAVATORS) ISUZU 3LD1	
Hydraulic Oil Filter.....	SFH 0403
EX35-2 (EXCAVATORS) KUBOTA V1505	
Hydraulic Oil Filter.....	SFH 4132
EX35-2 (EXCAVATORS) KUBOTA V1505H	
Hydraulic Oil Filter.....	SFH 4132
EX35U (EXCAVATORS) ISUZU 3LD1	
Air Filter Primary.....	SFA 1575P
Fuel Filter.....	SFF 3560
Hydraulic Oil Filter.....	SFH 4130
Hydraulic Oil Filter.....	SFH 0403
EX3600-5 (EXCAVATORS) ISUZU	
Air Filter Primary.....	SFA 1042P
Air Filter Secondary.....	SFA 8408S
Air Filter.....	SFA 8172
Fuel Filter.....	SFF 0009
Hydraulic Oil Filter.....	SFH 5299
Hydraulic Oil Filter.....	SFH 7402
Hydraulic Oil Filter.....	SFH 7634
Oil Filter By Pass.....	SFO 2777
Oil Filter Full Flow.....	SFO 178A
Oil Filter Full Flow.....	SFO 9708
EX36UE (EXCAVATORS) ISUZU 3LD1	
Air Filter Primary.....	SFA 1575P
Fuel Filter.....	SFF 3560
Hydraulic Oil Filter.....	SFH 0403
Hydraulic Oil Filter.....	SFH 4130
EX300 (EXCAVATORS) HITACHI EP100T	
Air Filter Set.....	SFA 8600SET
Air Filter Primary.....	SFA 2530P
Air Filter Secondary.....	SFA 4046S
Hydraulic Oil Filter Suction.....	SFH 0224
Hydraulic Oil Filter.....	SFH 7841
Oil Filter By Pass.....	SFO 8241
EX300LC-5 (EXCAVATORS) ISUZU 6SD1 TQA01	
Air Filter Secondary.....	SFA 9591S
Air Filter Primary.....	SFA 2214P
Air Filter Set.....	SFA 2214SET
Fuel Filter.....	SFF 6280
Fuel Filter.....	SFF 2631
Hydraulic Oil Filter.....	SFH 7841
Hydraulic Oil Filter Suction.....	SFH 0224
Hydraulic Oil Filter Suction.....	SFH 0224
Oil Filter Full Flow.....	SFO 6007
Oil Filter Full Flow.....	SFO 0163

MODEL/APPLICATION	SURE NO
-------------------	---------

HITACHI	
EX300LC-5 (EXCAVATORS) ISUZU 6SD1 TQA01	
Oil Filter By Pass.....	SFO 0163
EX310H-3C (EXCAVATORS) ISUZU 6SD1T	
Air Filter Set.....	SFA 6070SET
Air Filter Primary.....	SFA 3130P
Air Filter Primary.....	SFA 31302P
Air Filter Secondary.....	SFA 7599S
Fuel Filter.....	SFF 2631
Fuel Filter.....	SFF 6280
Hydraulic Oil Filter Suction.....	SFH 0224
Hydraulic Oil Filter.....	SFH 7841
Oil Filter Full Flow.....	SFO 6007
Oil Filter By Pass.....	SFO 0163
EX3500 (EXCAVATORS) HITACHI KT38C	
Air Filter Secondary.....	SFA 8408S
Air Filter Primary.....	SFA 1042P
Air Filter.....	SFA 8172
Coolant Filter.....	SFW 2073
Fuel/Water Separator.....	SFR 1216FW
Hydraulic Oil Filter.....	SFH 5299
Hydraulic Oil Filter.....	SFH 1334
Hydraulic Oil Filter.....	SFH 3321
Oil Filter By Pass.....	SFO 2777
Oil Filter Full Flow.....	SFO 2670
EX350H-5 (EXCAVATORS) ISUZU 6SD1 TQA01	
Air Filter Secondary.....	SFA 9591S
Air Filter Set.....	SFA 2214SET
Air Filter Primary.....	SFA 2214P
Fuel Filter.....	SFF 2631
Fuel Filter.....	SFF 6280
Hydraulic Oil Filter Suction.....	SFH 0224
Hydraulic Oil Filter.....	SFH 7841
Oil Filter Full Flow.....	SFO 6007
Oil Filter By Pass.....	SFO 0163
EX355 (EXCAVATORS) ISUZU 6HK1-XQA01 (S/N: TIER 2-UP)	
Air Filter Primary.....	SFA 0022PF
Air Filter Secondary.....	SFA 8813S
Air Filter Set.....	SFA 0022SET
Fuel Filter.....	SFF 2631
Hydraulic Oil Filter Suction.....	SFH 0224
Hydraulic Oil Filter.....	SFH 7841
EX355 (EXCAVATORS) ISUZU 6SD1-TQA03	
Air Filter Set.....	SFA 2214SET
Air Filter Primary.....	SFA 2214P
Air Filter Secondary.....	SFA 9591S
Fuel Filter.....	SFF 2631
Hydraulic Oil Filter.....	SFH 7841
Hydraulic Oil Filter Suction.....	SFH 0224
Oil Filter Full Flow.....	SFO 6007
Oil Filter By Pass.....	SFO 0163



To order, please call:
+1 8448 BE SURE; +1 (925) 566-8863

For Reference Only - May not be a direct cross



Email :
order@surefilter.us



Engine Application

MODEL/APPLICATION	SURE NO
HITACHI	

MODEL/APPLICATION	SURE NO
HITACHI	

MODEL/APPLICATION	SURE NO
HITACHI	

EX370-5
(EXCAVATORS)
ISUZU 6SD1 TQA01

Air Filter Primary.....	SFA 2214P
Air Filter Set.....	SFA 2214SET
Air Filter Secondary.....	SFA 9591S
Fuel Filter.....	SFF 6280
Fuel Filter.....	SFF 2631
Hydraulic Oil Filter Suction.....	SFH 0224
Hydraulic Oil Filter.....	SFH 7841
Oil Filter Full Flow.....	SFO 6007
Oil Filter By Pass.....	SFO 0163

EX33MU
(EXCAVATORS)
KUBOTA D1503V

Hydraulic Oil Filter.....	SFH 4132
---------------------------	----------

EX40
(EXCAVATORS)
ISUZU 4JC1 , 1991

Air Filter Primary.....	SFA 4723PF
Air Filter Set.....	SFA 4723SET
Hydraulic Oil Filter.....	SFH 4135

EX40
(EXCAVATORS)
ISUZU 4JC1

Hydraulic Oil Filter.....	SFH 4132
---------------------------	----------

EX40
(EXCAVATORS)
KUBOTA V1505TE

Fuel Filter.....	SFF 2564
------------------	----------

EX400
(EXCAVATORS)
HITACHI 6RB1T , 1988

Air Filter Secondary.....	SFA 9373S
Fuel Filter.....	SFF 0027
Fuel Filter.....	SFF 2631
Hydraulic Oil Filter.....	SFH 7841
Oil Filter Full Flow.....	SFO 0105
Oil Filter Full Flow.....	SFO 3265

EX400-3
(EXCAVATORS)
ISUZU 6RB1-TPQ

Air Filter Secondary.....	SFA 9373S
Fuel Filter.....	SFF 2631
Fuel Filter.....	SFF 6280
Hydraulic Oil Filter.....	SFH 7841
Hydraulic Oil Filter.....	SFH 7634
Oil Filter Full Flow.....	SFO 0105

EX400-5
(EXCAVATORS)
ISUZU 6RB1T

Cabin Air Filter.....	SFC 50249
-----------------------	-----------

EX400-5
(EXCAVATORS)

Air Filter Primary.....	SFA 1046P
Air Filter Secondary.....	SFA 9373S
Fuel Filter.....	SFF 6280
Fuel Filter.....	SFF 2631
Hydraulic Oil Filter.....	SFH 7634
Hydraulic Oil Filter.....	SFH 7841
Hydraulic Oil Filter.....	SFH 6141
Oil Filter By Pass.....	SFO 0163

EX40-2
(EXCAVATORS)
KUBOTA V2203-B

Air Filter Primary.....	SFA 4723PF
Air Filter Set.....	SFA 4723SET
Fuel Filter.....	SFF 3160
Hydraulic Oil Filter.....	SFH 4132
Hydraulic Oil Filter.....	SFH 4130

EX40U
(EXCAVATORS)
ISUZU 4LE1

Hydraulic Oil Filter.....	SFH 4132
---------------------------	----------

EX40UR
(EXCAVATORS)
ISUZU

Air Filter Primary.....	SFA 4723PF
Air Filter Set.....	SFA 4723SET
Fuel Filter.....	SFF 3560
Hydraulic Oil Filter.....	SFH 4135
Oil Filter Full Flow.....	SFO 4302

EX40UR
(EXCAVATORS)
ISUZU 3KR2

Hydraulic Oil Filter.....	SFH 4132
---------------------------	----------

EX455-2
(EXCAVATORS)

Air Filter Primary.....	SFA 1073P
Air Filter Secondary.....	SFA 7313S
Fuel Filter.....	SFF 2631
Hydraulic Oil Filter.....	SFH 7841
Hydraulic Oil Filter.....	SFH 6141

EX450-5
(EXCAVATORS)
ISUZU 6RB1T

Air Filter Primary.....	SFA 1046P
Air Filter Secondary.....	SFA 9373S
Fuel Filter.....	SFF 6280
Fuel Filter.....	SFF 2631
Hydraulic Oil Filter.....	SFH 7841
Hydraulic Oil Filter.....	SFH 7634
Oil Filter By Pass.....	SFO 0163

EX450-5
(EXCAVATORS)
w/Isuzu 6RB1T Eng.

Air Filter Set.....	SFA 24901SET
---------------------	--------------

EX455
(EXCAVATORS)
ISUZU 6RB1T

Air Filter Secondary.....	SFA 7313S
Air Filter Primary.....	SFA 1073P
Fuel Filter.....	SFF 6280
Fuel Filter.....	SFF 2631
Hydraulic Oil Filter.....	SFH 6705
Hydraulic Oil Filter.....	SFH 7841
Oil Filter By Pass.....	SFO 0163

EX455
(EXCAVATORS)
w/Isuzu 6RB1T Eng.

Air Filter Set.....	SFA 24901SET
---------------------	--------------

EX455-5
(EXCAVATORS)
ISUZU 6RB1T

Air Filter Secondary.....	SFA 9373S
---------------------------	-----------

EX455-5
(EXCAVATORS)
ISUZU 6RB1T

Air Filter Primary.....	SFA 1046P
Fuel Filter.....	SFF 2631
Fuel Filter.....	SFF 6280
Hydraulic Oil Filter.....	SFH 7841
Hydraulic Oil Filter.....	SFH 7634
Oil Filter By Pass.....	SFO 0163

EX456
(EXCAVATORS)
ISUZU 6WG1 (S/N: TIER 2-UP)

Air Filter Primary.....	SFA 1073P
Air Filter Secondary.....	SFA 7313S
Fuel Filter.....	SFF 2631
Fuel Filter.....	SFF 6280
Hydraulic Oil Filter.....	SFH 7841

EX456
(EXCAVATORS)
w/Isuzu 6WG1 Eng.

Air Filter Set.....	SFA 24901SET
---------------------	--------------

EX45
(EXCAVATORS)
ISUZU 4JC1

Hydraulic Oil Filter.....	SFH 4132
---------------------------	----------

EX45-2
(EXCAVATORS)
KUBOTA V2203

Hydraulic Oil Filter.....	SFH 4132
---------------------------	----------

EX45-2
(EXCAVATORS)
KUBOTA V2203-B

Hydraulic Oil Filter.....	SFH 4132
---------------------------	----------

EX50U
(EXCAVATORS)
ISUZU 4LE1

Air Filter Primary.....	SFA 4723PF
Air Filter Secondary.....	SFA 1278S
Air Filter Set.....	SFA 4723SET
Fuel Filter.....	SFF 3560
Hydraulic Oil Filter.....	SFH 4130
Hydraulic Oil Filter.....	SFH 4132

EX50UR
(EXCAVATORS)
3AB1

Hydraulic Oil Filter.....	SFH 0403
---------------------------	----------

EX50UR
(EXCAVATORS)
ISUZU 3AB1

Fuel Filter.....	SFF 0057
Fuel Filter.....	SFF 2001
Hydraulic Oil Filter.....	SFH 7841

EX550
(EXCAVATORS)
CUMMINS N14

Cabin Air Filter.....	SFC 50249
-----------------------	-----------

EX550
(EXCAVATORS)
CUMMINS NTA-855

Air Filter Primary.....	SFA 1073P
Air Filter Secondary.....	SFA 7313S
Coolant Filter.....	SFW 2074
Fuel/Water Separator.....	SFR 1212FW
Hydraulic Oil Filter.....	SFH 7634
Hydraulic Oil Filter.....	SFH 7841



Engine Application

MODEL/APPLICATION	SURE NO
-------------------	---------

HITACHI	
EX550 (EXCAVATORS) CUMMINS NTA-855	Oil Filter Combination..... SFO 2300
EX550 (EXCAVATORS) CUMMINS N14-C400	Air Filter Secondary..... SFA 7313S Air Filter Primary..... SFA 1073P Coolant Filter..... SFW 2074 Fuel/Water Separator..... SFR 1212FW Hydraulic Oil Filter..... SFH 7634 Hydraulic Oil Filter..... SFH 7841 Oil Filter Combination..... SFO 2300
EX550 (EXCAVATORS) w/Cummins N14 Eng	Air Filter Set..... SFA 24901SET
EX550-3 (EXCAVATORS) CUMMINS N14	Cabin Air Filter..... SFC 50249
EX550-3 (EXCAVATORS) w/Cummins N14 Eng	Air Filter Set..... SFA 24901SET
EX550-5 (EXCAVATORS) CUMMINS N14	Cabin Air Filter..... SFC 50249
EX550-5 (EXCAVATORS) CUMMINS N14-C400	Air Filter Primary..... SFA 1073P Air Filter Secondary..... SFA 7313S Coolant Filter..... SFW 2074 Fuel/Water Separator..... SFR 1212FW Hydraulic Oil Filter..... SFH 7634 Hydraulic Oil Filter..... SFH 7841 Oil Filter Combination..... SFO 2300
EX550-5 (EXCAVATORS) w/Cummins N14 Eng	Air Filter Set..... SFA 24901SET
EX5500-5 (EXCAVATORS) CUMMINS QSK45-C , 2005	Air Filter Secondary..... SFA 0857S Air Filter..... SFA 8172 Coolant Filter..... SFW 2076 Fuel/Water Separator..... SFR 3112FW Hydraulic Oil Filter..... SFH 5299 Hydraulic Oil Filter..... SFH 7634
EX5500-5 (EXCAVATORS) CUMMINS QSK45-C	Hydraulic Oil Filter..... SFH 0542
EX55UR (EXCAVATORS) NISSAN TD2340-10	Air Filter Set..... SFA 4723SET Air Filter Primary..... SFA 4723PF Fuel Filter..... SFF 2001 Hydraulic Oil Filter..... SFH 4135 Hydraulic Oil Filter..... SFH 4132

MODEL/APPLICATION	SURE NO
-------------------	---------

HITACHI	
EX55UR-3 (EXCAVATORS) ISUZU 4LE1	Air Filter Secondary..... SFA 2858S Air Filter Primary..... SFA 1575P Fuel Filter..... SFF 3560 Hydraulic Oil Filter..... SFH 4130
EX5500-6 (EXCAVATORS) CUMMINS QSK50	Hydraulic Oil Filter..... SFH 0542
EX5600-6 (EXCAVATORS) CUMMINS QSK50-C	Hydraulic Oil Filter..... SFH 0542
EX58MU (EXCAVATORS) ISUZU 4LE1	Hydraulic Oil Filter..... SFH 4132
EX60 (EXCAVATORS) HITACHI FD3304 , 1988	Air Filter Primary..... SFA 1052PF Fuel Filter..... SFF 2001 Hydraulic Oil Filter..... SFH 0987 Hydraulic Oil Filter..... SFH 7841
EX60 (EXCAVATORS) HITACHI FD3302	Air Filter Primary..... SFA 1052PF
EX60 (EXCAVATORS) NISSAN FD3304	Hydraulic Oil Filter..... SFH 0403
EX600-3 (EXCAVATORS) CUMMINS N14	Cabin Air Filter..... SFC 50249
EX600-3 (EXCAVATORS) CUMMINS N14-C400	Air Filter Primary..... SFA 1073P Air Filter Secondary..... SFA 7313S Coolant Filter..... SFW 2074 Fuel/Water Separator..... SFR 1212FW Hydraulic Oil Filter..... SFH 7841 Hydraulic Oil Filter..... SFH 7634 Oil Filter Combination..... SFO 2300
EX600-3 (EXCAVATORS) w/Cummins N14 Eng	Air Filter Set..... SFA 24901SET
EX60-2 (EXCAVATORS) HITACHI BD3004 , 1992	Air Filter Secondary..... SFA 2769S Air Filter Primary..... SFA 5436P Fuel Filter..... SFF 2001 Hydraulic Oil Filter..... SFH 7841
EX60-2 (EXCAVATORS) NISSAN BD3004-19	Hydraulic Oil Filter..... SFH 0403

MODEL/APPLICATION	SURE NO
-------------------	---------

HITACHI	
EX60-2 (EXCAVATORS) NISSAN BD3004-19	Fuel Filter..... SFF 0057
EX60-3 (EXCAVATORS) NISSAN BD3004	Hydraulic Oil Filter..... SFH 0403
EX60-5 (EXCAVATORS) NISSAN BD3004	Cabin Air Filter..... SFC 50249 Hydraulic Oil Filter..... SFH 0403
EX60-5 (EXCAVATORS) NISSAN BD3004-19	Air Filter Primary..... SFA 5436P Air Filter Secondary..... SFA 2769S Fuel Filter..... SFF 2001 Hydraulic Oil Filter..... SFH 7841
EX60UR (EXCAVATORS) ISUZU 4JB1 , 1990	Air Filter Primary..... SFA 1052PF Fuel Filter..... SFF 2001 Hydraulic Oil Filter..... SFH 7841
EX60UR (EXCAVATORS) ISUZU 4JB1	Hydraulic Oil Filter..... SFH 0403
EX60URG (EXCAVATORS) ISUZU 4JB1	Hydraulic Oil Filter..... SFH 0403
EX60WD (EXCAVATORS) HITACHI FD3304 , 1990	Air Filter Primary..... SFA 1052PF Fuel Filter..... SFF 2001 Hydraulic Oil Filter..... SFH 0987 Hydraulic Oil Filter..... SFH 7841
EX60WD (EXCAVATORS) ISUZU 4BD1	Hydraulic Oil Filter..... SFH 0403
EX60WD (EXCAVATORS) NISSAN FD3304	Hydraulic Oil Filter..... SFH 0403
EX60WD-2 (EXCAVATORS) HITACHI BD3004 , 1992	Air Filter Primary..... SFA 5436P Fuel Filter..... SFF 2001 Hydraulic Oil Filter..... SFH 0987 Hydraulic Oil Filter..... SFH 7841
EX60WD-2 (EXCAVATORS) NISSAN BD3004	Hydraulic Oil Filter..... SFH 0403
EX600 (EXCAVATORS)	Air Filter Secondary..... SFA 7313S Air Filter Primary..... SFA 1073P Coolant Filter..... SFW 2074



To order, please call:
+1 8448 BE SURE; +1 (925) 566-8863

For Reference Only - May not be a direct cross



Email :
order@suresfilter.us



Engine Application

MODEL/APPLICATION	SURE NO
HITACHI	

EX600 (EXCAVATORS)	
Fuel Filter.....	SFF 2631
Hydraulic Oil Filter.....	SFH 7634
Hydraulic Oil Filter.....	SFH 7841
EX600H-5 (EXCAVATORS) CUMMINS N14	
Cabin Air Filter.....	SFC 50249
EX600H-5 (EXCAVATORS) CUMMINS N14-C400	
Air Filter Secondary.....	SFA 7313S
Air Filter Primary.....	SFA 1073P
Coolant Filter.....	SFW 2074
Fuel/Water Separator.....	SFR 1212FW
Hydraulic Oil Filter.....	SFH 7634
Hydraulic Oil Filter.....	SFH 7841
Oil Filter Combination.....	SFO 2300
EX600H-5 (EXCAVATORS) w/Cummins N14 Eng	
Air Filter Set.....	SFA 24901SET
EX605R (EXCAVATORS) HITACHI FD3304	
Air Filter Primary.....	SFA 1052PF
Hydraulic Oil Filter.....	SFH 7841
Hydraulic Oil Filter.....	SFH 0987
EX605R (EXCAVATORS) NISSAN FD3304	
Hydraulic Oil Filter.....	SFH 0403
EX600H-3 (EXCAVATORS) CUMMINS N14	
Cabin Air Filter.....	SFC 50249
EX600H-3 (EXCAVATORS) w/Cummins N14 Eng	
Air Filter Set.....	SFA 24901SET
EX600LC-3 (EXCAVATORS) CUMMINS N14	
Cabin Air Filter.....	SFC 50249
EX600LC-3 (EXCAVATORS) w/Cummins N14 Eng	
Air Filter Set.....	SFA 24901SET
EX600LCH-3 (EXCAVATORS) CUMMINS N14	
Cabin Air Filter.....	SFC 50249
EX600LCH-3 (EXCAVATORS) w/Cummins N14 Eng	
Air Filter Set.....	SFA 24901SET
EX600-5 (EXCAVATORS) CUMMINS N14	
Cabin Air Filter.....	SFC 50249
EX600-5 (EXCAVATORS) w/Cummins N14 Eng	
Air Filter Set.....	SFA 24901SET

MODEL/APPLICATION	SURE NO
HITACHI	

EX600LC-5 (EXCAVATORS) CUMMINS N14	
Cabin Air Filter.....	SFC 50249
EX600LC-5 (EXCAVATORS) w/Cummins N14 Eng	
Air Filter Set.....	SFA 24901SET
EX600LCH-5 (EXCAVATORS) CUMMINS N14	
Cabin Air Filter.....	SFC 50249
EX600LCH-5 (EXCAVATORS) w/Cummins N14 Eng	
Air Filter Set.....	SFA 24901SET
EX60-1 (EXCAVATORS) NISSAN FD3304	
Hydraulic Oil Filter.....	SFH 0403
EX60LC-5 (EXCAVATORS) NISSAN BD3004	
Cabin Air Filter.....	SFC 50249
Hydraulic Oil Filter.....	SFH 0403
EX60WD-1 (EXCAVATORS) NISSAN FD3304	
Hydraulic Oil Filter.....	SFH 0403
EX700 (EXCAVATORS) CUMMINS NTA-855 , 1995	
Air Filter Secondary.....	SFA 2320S
Air Filter Primary.....	SFA 2180P
Air Filter Set.....	SFA 2180SET
Cabin Air Filter.....	SFC 13531
Coolant Filter.....	SFW 2075
Fuel Filter.....	SFF 0105D
Hydraulic Oil Filter.....	SFH 7841
Oil Filter Combination.....	SFO 2300
EX700 (EXCAVATORS) CUMMINS NTA855B	
Hydraulic Oil Filter.....	SFH 0542
EX750 (EXCAVATORS) CUMMINS N14 SERIES	
Air Filter Secondary.....	SFA 7313S
Air Filter Primary.....	SFA 1073P
Coolant Filter.....	SFW 2074
Fuel/Water Separator.....	SFR 1212FW
Hydraulic Oil Filter.....	SFH 7634
Hydraulic Oil Filter.....	SFH 7841
Oil Filter Combination.....	SFO 2300
EX750-5 (EXCAVATORS) CUMMINS N14-C	
Air Filter Set.....	SFA 2180SET
Air Filter Primary.....	SFA 2180P
Air Filter Secondary.....	SFA 2320S
Cabin Air Filter.....	SFC 50249
Coolant Filter.....	SFW 2074
Fuel/Water Separator.....	SFR 1212FW
Hydraulic Oil Filter.....	SFH 6141
Hydraulic Oil Filter.....	SFH 7841

MODEL/APPLICATION	SURE NO
HITACHI	

EX750-5 (EXCAVATORS) CUMMINS N14-C	
Oil Filter Combination.....	SFO 2300
EX75UR (EXCAVATORS)	
Air Filter Primary.....	SFA 5436P
Fuel Filter.....	SFF 2001
Hydraulic Oil Filter.....	SFH 7841
Hydraulic Oil Filter.....	SFH 0403
EX75UR-3 (EXCAVATORS) NISSAN BD3004	
Hydraulic Oil Filter.....	SFH 0403
EX75UR-3 (EXCAVATORS) NISSAN BD3004-20	
Air Filter Primary.....	SFA 5436P
Fuel Filter.....	SFF 2001
Hydraulic Oil Filter.....	SFH 7841
EX75US-7 (EXCAVATORS) ISUZU 4JB1	
Hydraulic Oil Filter.....	SFH 0403
EX75US-7 (EXCAVATORS) ISUZU 4JG1	
Air Filter Secondary.....	SFA 2769S
Air Filter Primary.....	SFA 5436P
Fuel Filter.....	SFF 2001
Hydraulic Oil Filter.....	SFH 7841
EX800 (EXCAVATORS)	
Air Filter Primary.....	SFA 2180P
Air Filter Secondary.....	SFA 2320S
Air Filter Set.....	SFA 2180SET
Coolant Filter.....	SFW 2074
Fuel Filter.....	SFF 2631
Hydraulic Oil Filter.....	SFH 6141
Hydraulic Oil Filter.....	SFH 7841
EX800-5 (EXCAVATORS)	
Air Filter Set.....	SFA 2180SET
Air Filter Secondary.....	SFA 2320S
Air Filter Primary.....	SFA 2180P
Coolant Filter.....	SFW 2074
Fuel/Water Separator.....	SFR 1212FW
Hydraulic Oil Filter.....	SFH 6141
Hydraulic Oil Filter.....	SFH 7841
Oil Filter Combination.....	SFO 2300
EX8000 (EXCAVATORS) HITACHI , 2005	
Air Filter Secondary.....	SFA 0857S
Coolant Filter.....	SFW 2076
Coolant Filter.....	SFW 2075
Fuel Filter.....	SFF 4234
Fuel Filter.....	SFF 0009
Hydraulic Oil Filter.....	SFH 5299
Hydraulic Oil Filter.....	SFH 7634



To order, please call:
+1 8448 BE SURE; +1 (925) 566-8863

For Reference Only - May not be a direct cross

A 10



Email :
order@surefilter.us



Engine Application

MODEL/APPLICATION	SURE NO
HITACHI	
EX8000 (EXCAVATORS) MITSUBISHI S16RY1TAA22EA	
Hydraulic Oil Filter.....	SFH 0542
EX800H-5 (EXCAVATORS) CUMMINS N14-C	
Air Filter Primary.....	SFA 2180P
Air Filter Set.....	SFA 2180SET
Air Filter Secondary.....	SFA 2320S
Cabin Air Filter.....	SFC 50249
Coolant Filter.....	SFW 2074
Fuel/Water Separator.....	SFR 1212FW
Hydraulic Oil Filter.....	SFH 7841
Hydraulic Oil Filter.....	SFH 6141
Oil Filter Combination.....	SFO 2300
EX80-5 (EXCAVATORS) NISSAN BD3004	
Cabin Air Filter.....	SFC 50249
Hydraulic Oil Filter.....	SFH 0403
EX80-5 (EXCAVATORS) NISSAN BD3004-19	
Air Filter Secondary.....	SFA 2769S
Air Filter Primary.....	SFA 5436P
Fuel Filter.....	SFF 2001
Hydraulic Oil Filter.....	SFH 7841
EX8-2B (EXCAVATORS) KUBOTA Z482B	
Fuel Filter.....	SFF 3560
EX80U (EXCAVATORS) NISSAN BD30	
Hydraulic Oil Filter.....	SFH 0403
EX90 (EXCAVATORS) HITACHI 4BD1 , 1988	
Air Filter Primary.....	SFA 1052PF
Fuel Filter.....	SFF 6130
Hydraulic Oil Filter.....	SFH 0987
Hydraulic Oil Filter.....	SFH 7841
Hydraulic Oil Filter.....	SFH 7353
Oil Filter Full Flow.....	SFO 3853
FH130-3 (EXCAVATORS) IVECO	
Fuel Filter.....	SFF 3291
Hydraulic Oil Filter.....	SFH 7841
Hydraulic Oil Filter.....	SFH 7353
Hydraulic Oil Filter Suction.....	SFH 0224
Oil Filter Combination.....	SFO 3628
FH130W-3 (EXCAVATORS) CUMMINS	
Air Filter Primary.....	SFA 4905P
Air Filter Secondary.....	SFA 4103S
Air Filter Secondary.....	SFA 4589S
Fuel Filter Secondary.....	SFF 5052
Fuel/Water Separator.....	SFR 1280FW
Hydraulic Oil Filter Suction.....	SFH 0224
Hydraulic Oil Filter.....	SFH 7353
Oil Filter Full Flow.....	SFO 3345

MODEL/APPLICATION	SURE NO
HITACHI	
FH120 (EXCAVATORS) IVECO 8065T	
Fuel Filter.....	SFF 3291
Hydraulic Oil Filter.....	SFH 7353
Hydraulic Oil Filter.....	SFH 7841
Hydraulic Oil Filter Suction.....	SFH 0224
FH150W-3 (EXCAVATORS) CUMMINS	
Air Filter Primary.....	SFA 4905P
Air Filter Secondary.....	SFA 4589S
Fuel Filter Secondary.....	SFF 5052
Fuel/Water Separator.....	SFR 1280FW
Hydraulic Oil Filter Suction.....	SFH 0224
Hydraulic Oil Filter.....	SFH 7353
Oil Filter Full Flow.....	SFO 3349
FH200 (EXCAVATORS) IVECO	
Air Filter Primary.....	SFA 1555PF
Air Filter Set.....	SFA 1555SET
Air Filter Secondary.....	SFA 4589S
Hydraulic Oil Filter.....	SFH 7841
Hydraulic Oil Filter Suction.....	SFH 0224
Oil Filter Combination.....	SFO 3628
FH220 (EXCAVATORS) HITACHI 8365.SI.11.ALL.010	
Air Filter Set.....	SFA 1531SET
Air Filter Secondary.....	SFA 0678S
Air Filter Primary.....	SFA 1531PF
Coolant Filter.....	SFW 2071
Fuel Filter.....	SFF 1605
Fuel Filter.....	SFF 5064
Hydraulic Oil Filter Suction.....	SFH 0224
Hydraulic Oil Filter.....	SFH 7841
Oil Filter Combination.....	SFO 3594
FH270.3 (EXCAVATORS) CUMMINS 6CT8.3	
Air Filter Secondary.....	SFA 0678S
Air Filter Primary.....	SFA 1531PF
Air Filter Set.....	SFA 1531SET
Coolant Filter.....	SFW 2071
Coolant Filter.....	SFW 2073
Fuel Filter Secondary.....	SFF 5052
Fuel/Water Separator.....	SFR 1280FW
Hydraulic Oil Filter Suction.....	SFH 0224
Hydraulic Oil Filter.....	SFH 7841
Oil Filter Combination.....	SFO 2300
FH240-3 (EXCAVATORS) IVECO (S/N: 244X0001-UP)	
Air Filter Primary.....	SFA 1531PF
Air Filter Secondary.....	SFA 0678S
Air Filter Set.....	SFA 1531SET
Fuel Filter.....	SFF 7240
Hydraulic Oil Filter Suction.....	SFH 0224
Hydraulic Oil Filter.....	SFH 7841
Oil Filter Combination.....	SFO 3594

MODEL/APPLICATION	SURE NO
HITACHI	
FH240-3 (EXCAVATORS) IVECO (S/N: TO-223X9999)	
Air Filter Set.....	SFA 1531SET
Air Filter Secondary.....	SFA 0678S
Air Filter Primary.....	SFA 1531PF
Fuel Filter.....	SFF 1605
Fuel Filter.....	SFF 5064
Hydraulic Oil Filter.....	SFH 7841
Hydraulic Oil Filter Suction.....	SFH 0224
Oil Filter Combination.....	SFO 3594
FH300 (EXCAVATORS) HITACHI 8365.SI.11.ALL011	
Air Filter Secondary.....	SFA 0678S
Air Filter Primary.....	SFA 1531PF
Air Filter Set.....	SFA 1531SET
Coolant Filter.....	SFW 2071
Fuel Filter.....	SFF 1605
Fuel Filter.....	SFF 5064
Hydraulic Oil Filter Suction.....	SFH 0224
Hydraulic Oil Filter.....	SFH 7841
Oil Filter Combination.....	SFO 3594
FH330.3 (EXCAVATORS) ISUZU 6SD1T	
Air Filter Set.....	SFA 6070SET
Air Filter Primary.....	SFA 31302P
Air Filter Primary.....	SFA 3130P
Fuel Filter.....	SFF 2631
Fuel/Water Separator.....	SFR 1212FW
Hydraulic Oil Filter.....	SFH 7841
Oil Filter By Pass.....	SFO 2777
Oil Filter By Pass.....	SFO 0163
Oil Filter Full Flow.....	SFO 6007
FH400 (EXCAVATORS) FIAT 8215.22.400	
Air Filter Secondary.....	SFA 9373S
Air Filter Primary.....	SFA 1046P
Fuel Filter.....	SFF 1605
Fuel Filter.....	SFF 5064
Hydraulic Oil Filter.....	SFH 7841
Hydraulic Oil Filter Suction.....	SFH 0224
FH450-3 (EXCAVATORS) ISUZU 6RB1	
Air Filter Secondary.....	SFA 9373S
Air Filter Primary.....	SFA 1046P
Fuel Filter.....	SFF 2631
Hydraulic Oil Filter.....	SFH 7841
Oil Filter By Pass.....	SFO 0163
FH65W (EXCAVATORS) PERKINS	
Air Filter Secondary.....	SFA 4103S
Fuel Filter.....	SFF 3291
FK600 (CRANES) ISUZU (S/N: K130220037-UP)	
Air Filter.....	SFA 1240F



To order, please call:
+1 8448 BE SURE; +1 (925) 566-8863

For Reference Only - May not be a direct cross



Email :
order@suresfilter.us



Engine Application

MODEL/APPLICATION	SURE NO
HITACHI	
FR100 (LOADERS) IVECO	
Air Filter Secondary.....	SFA 4103S
Fuel Filter.....	SFF 0167
Hydraulic Oil Filter.....	SFH 0147
FR130 (LOADERS) FIAT 8065T	
Air Filter Secondary.....	SFA 4589S
Air Filter Set.....	SFA 0434SET
Air Filter Primary.....	SFA 0434PF
Fuel Filter.....	SFF 0723
Hydraulic Oil Filter Transmission..	SFH 6837
Oil Filter Combination.....	SFO 3628
FR160 (LOADERS) FIAT 8365T	
Air Filter Secondary.....	SFA 0678S
Coolant Filter.....	SFW 2071
Fuel Filter.....	SFF 5064
Hydraulic Oil Filter Transmission..	SFH 6837
Oil Filter Combination.....	SFO 3594
FR139-7 (EXCAVATORS)	
Air Filter Secondary.....	SFA 8863S
Air Filter Primary.....	SFA 8863P
FR70 (LOADERS)	
Air Filter Primary.....	SFA 0760PF
Air Filter Secondary.....	SFA 3776S
Fuel Filter.....	SFF 3291
Hydraulic Oil Filter.....	SFH 0147
Oil Filter Full Flow.....	SFO 7566
FR90 (LOADERS) IVECO	
Air Filter Secondary.....	SFA 4103S
Fuel Filter.....	SFF 3291
Hydraulic Oil Filter.....	SFH 0147
Oil Filter Combination.....	SFO 3628
EX5500 (EXCAVATORS) CUMMINS KTA50	
Hydraulic Oil Filter.....	SFH 0542
HX140B (FORKLIFTS) KUBOTA D1105-K , 2004	
Fuel Filter.....	SFF 1045
Hydraulic Oil Filter.....	SFH 4130
HX140B (BOOM-LIFT) KUBOTA D1105-K	
Hydraulic Oil Filter.....	SFH 4132
HX220B (FORKLIFTS) ISUZU 48G1 , 2008	
Air Filter Secondary.....	SFA 7975S
Fuel Filter.....	SFF 2001
Hydraulic Oil Filter Suction.....	SFH 0224
Hydraulic Oil Filter.....	SFH 7841
Oil Filter Full Flow.....	SFO 3853

MODEL/APPLICATION	SURE NO
HITACHI	
HX99B (FORKLIFTS) KUBOTA D1105-BH , 2004	
Fuel Filter.....	SFF 1045
Hydraulic Oil Filter.....	SFH 4130
HX99B (BOOM-LIFT) KUBOTA D1105-BH	
Hydraulic Oil Filter.....	SFH 4132
KH100 (CRANES) HINO DS50A	
Air Filter.....	SFA 1045F
KH100-2 (CRANES) HITACHI EL100	
Air Filter.....	SFA 1045F
Oil Filter Full Flow.....	SFO 4754
KH125-2 (CRANES) HINO DS50 (S/N: T0-400)	
Air Filter.....	SFA 1045F
Fuel Filter.....	SFF 1040
Oil Filter Full Flow.....	SFO 4754
KH125-3 (CRANES) HITACHI EM100	
Air Filter Primary.....	SFA 1080P
Air Filter Set.....	SFA 9025SET
Fuel Filter.....	SFF 2390
Hydraulic Oil Filter.....	SFH 1430
Hydraulic Oil Filter.....	SFH 4135
Oil Filter Full Flow.....	SFO 4754
KH150-2 (CRANES) NISSAN PD604	
Fuel Filter.....	SFF 9128
Hydraulic Oil Filter.....	SFH 1430
KH150-3 (CRANES) HINO H06CT (S/N: 911-UP)	
Air Filter Primary.....	SFA 1080P
Air Filter Set.....	SFA 9025SET
Hydraulic Oil Filter.....	SFH 4135
Oil Filter By Pass.....	SFO 8241
KH150-3 (CRANES) HITACHI BF10L513	
Air Filter Primary.....	SFA 1087P
Hydraulic Oil Filter.....	SFH 4135
Oil Filter Full Flow.....	SFO 4054
KH150-3 (CRANES) HITACHI EM100 (S/N: T0-910)	
Air Filter Set.....	SFA 9025SET
Air Filter Primary.....	SFA 1080P
Fuel Filter.....	SFF 2390
Hydraulic Oil Filter.....	SFH 4135
Oil Filter Full Flow.....	SFO 4754
KH180 (CRANES) HITACHI DH100	
Fuel Filter.....	SFF 1010
Oil Filter Full Flow.....	SFO 3265

MODEL/APPLICATION	SURE NO
HITACHI	
KH230-3 (CRANES) HINO EM100 (S/N: 106-UP)	
Air Filter Primary.....	SFA 1080P
Air Filter Set.....	SFA 9025SET
Fuel Filter.....	SFF 2390
Hydraulic Oil Filter.....	SFH 4135
Oil Filter Full Flow.....	SFO 4754
KH230-3 (CRANES) HINO EM100 (S/N: 2450199-UP)	
Air Filter Primary.....	SFA 1080P
Air Filter Set.....	SFA 9025SET
Fuel Filter.....	SFF 2390
Hydraulic Oil Filter.....	SFH 1430
Hydraulic Oil Filter.....	SFH 4135
Oil Filter Full Flow.....	SFO 4754
KH230-3 (CRANES) HINO EM100 (S/N: 2450200-UP)	
Air Filter Set.....	SFA 9025SET
Air Filter Primary.....	SFA 1080P
Fuel Filter.....	SFF 2390
Hydraulic Oil Filter.....	SFH 1430
Hydraulic Oil Filter.....	SFH 4135
Oil Filter Full Flow.....	SFO 4754
KH300 (CRANES) HITACHI 8MA1	
Air Filter.....	SFA 1240F
Fuel Filter.....	SFF 1010
KH300 (CRANES) ISUZU (S/N: 2100888-UP)	
Air Filter.....	SFA 1240F
Fuel Filter.....	SFF 1010
KH300-2 (CRANES) ISUZU 8MA1	
Air Filter.....	SFA 1240F
Fuel Filter.....	SFF 1010
KH300-3 (CRANES) ISUZU 6RB1	
Air Filter.....	SFA 1240F
Air Filter Primary.....	SFA 1080P
Air Filter Set.....	SFA 9025SET
Fuel Filter.....	SFF 2631
Fuel Filter.....	SFF 0027
Hydraulic Oil Filter.....	SFH 4135
Oil Filter Full Flow.....	SFO 3265
Oil Filter Full Flow.....	SFO 0105
KH500 (CRANES) ISUZU 12PB1	
Air Filter.....	SFA 1240F
Fuel Filter.....	SFF 0207
Hydraulic Oil Filter.....	SFH 0084
KH500-3 (CRANES) ISUZU 6RB1T	
Air Filter Secondary.....	SFA 9373S
Air Filter Primary.....	SFA 1046P
Fuel Filter.....	SFF 2631



To order, please call:
+1 8448 BE SURE; +1 (925) 566-8863

For Reference Only - May not be a direct cross



Email :
order@suresfilter.us



Engine Application

MODEL/APPLICATION	SURE NO
HITACHI	
KH500-3 (CRANES) ISUZU 6RB1T	
Hydraulic Oil Filter.....	SFH 4135
Oil Filter Full Flow.....	SFO 0105
KH550 (CRANES) ISUZU 6BD1	
Fuel Filter.....	SFF 2564
KH70 (CRANES) HINO DS50A	
Air Filter.....	SFA 1045F
Fuel Filter.....	SFF 1040
Oil Filter Full Flow.....	SFO 4754
KH700 (CRANES) ISUZU 12PB1 (S/N: 2530258-UP)	
Air Filter.....	SFA 1240F
Fuel Filter.....	SFF 0207
Hydraulic Oil Filter.....	SFH 4135
KH700 (CRANES) ISUZU 8MA1	
Air Filter.....	SFA 1240F
Fuel Filter.....	SFF 1010
KH700-2 (CRANES) ISUZU 12PB1	
Air Filter.....	SFA 1240F
Fuel Filter.....	SFF 0207
KH850-3 (CRANES) ISUZU 6RB1T	
Air Filter Secondary.....	SFA 9373S
Air Filter Primary.....	SFA 1046P
Fuel Filter.....	SFF 2631
Hydraulic Oil Filter.....	SFH 4135
Oil Filter Full Flow.....	SFO 0105
LX145E (LOADERS) ISUZU BB 6BG1 TRF (S/N: T0-01499) , 2004	
Air Filter Set.....	SFA 0434SET
Air Filter Primary.....	SFA 0434PF
Fuel Filter.....	SFF 0052
Oil Filter Full Flow.....	SFO 6007
Oil Filter By Pass.....	SFO 0048
LX145E (LOADERS) ISUZU 6BG1	
Fuel Filter.....	SFF 2564
LX145E (LOADERS) S/N: 01500-UP	
Air Filter Primary.....	SFA 0434PF
Air Filter Set.....	SFA 0434SET
Fuel Filter.....	SFF 0052
LX145E-2 (LOADERS) ISUZU BB 6BG1 TRF (S/N: 01500-UP) , 2006	
Air Filter Set.....	SFA 0434SET
Air Filter Primary.....	SFA 0434PF
Fuel Filter.....	SFF 0052
Oil Filter Full Flow.....	SFO 6007

MODEL/APPLICATION	SURE NO
HITACHI	
LX145E-2 (LOADERS) ISUZU 6BG1	
Fuel Filter.....	SFF 2564
LX170 (LOADERS) ISUZU , 2004	
Air Filter Primary.....	SFA 0434PF
Air Filter Set.....	SFA 0434SET
Fuel/Water Separator.....	SFR 1212FW
Oil Filter By Pass.....	SFO 0048
LX170E (LOADERS) ISUZU BB 6BG1 TRF (S/N: T0-01499) , 2006	
Air Filter Primary.....	SFA 0434PF
Air Filter Set.....	SFA 0434SET
Fuel Filter.....	SFF 0052
Oil Filter Full Flow.....	SFO 6007
Oil Filter By Pass.....	SFO 0048
LX170E (LOADERS) ISUZU 6BG1	
Fuel Filter.....	SFF 2564
LX170E (LOADERS) S/N: 01500-UP	
Air Filter Set.....	SFA 0434SET
Air Filter Primary.....	SFA 0434PF
Fuel Filter.....	SFF 0052
LX170E-2 (LOADERS) ISUZU BB 6BG1 TRF , 2006	
Air Filter Primary.....	SFA 0434PF
Air Filter Set.....	SFA 0434SET
Fuel Filter.....	SFF 0052
Oil Filter Full Flow.....	SFO 6007
LX170E-2 (LOADERS) ISUZU 6BG1	
Fuel Filter.....	SFF 2564
LX150-2 (LOADERS) w/JD 6076 Eng.	
Air Filter Set.....	SFA 3189SET
Air Filter Primary.....	SFA 3189P
Air Filter Secondary.....	SFA 6319S
LX150-2 (LOADERS) w/JD 6081 Eng.	
Air Filter Secondary.....	SFA 6319S
Air Filter Set.....	SFA 3189SET
Air Filter Primary.....	SFA 3189P
LX100 (LOADERS) ISUZU 6BD1T	
Fuel Filter.....	SFF 2564
LX100-1 (LOADERS) ISUZU 6BD1T	
Fuel Filter.....	SFF 2564
LX100-2 (LOADERS) ISUZU W06DT	
Fuel Filter.....	SFF 2564

MODEL/APPLICATION	SURE NO
HITACHI	
LX100-2 (LOADERS) John Deere 6059	
Fuel Filter.....	SFF 2564
LX210 (LOADERS) ISUZU , 2004	
Air Filter Primary.....	SFA 0418P
Air Filter Secondary.....	SFA 0490S
Fuel Filter.....	SFF 2631
LX210E (LOADERS) ISUZU 6HK1 TQF (S/N: T0-01499) , 2006	
Air Filter Primary.....	SFA 0418P
Air Filter Secondary.....	SFA 0490S
Fuel Filter.....	SFF 2631
LX290 (LOADERS) ISUZU , 2004	
Air Filter Primary.....	SFA 78681PF
Air Filter Set.....	SFA 7868SETF
Air Filter Secondary.....	SFA 7869S
Air Filter Primary.....	SFA 7868PF
Fuel Filter.....	SFF 2631
Oil Filter Full Flow.....	SFO 6007
Oil Filter By Pass.....	SFO 0163
LX290E (LOADERS) ISUZU 6SD1 XQF (S/N: T0-01499) , 2006	
Air Filter Primary.....	SFA 78681PF
Air Filter Primary.....	SFA 78681PF
Air Filter Set.....	SFA 7868SETF
Air Filter Secondary.....	SFA 7869S
Fuel Filter.....	SFF 2631
Oil Filter Full Flow.....	SFO 6007
Oil Filter By Pass.....	SFO 0163
LX300-7A (LOADERS) ISUZU 6WG1 XQC-01 (S/N: 01102-UP) , 2006	
Air Filter Secondary.....	SFA 0883S
Fuel Filter.....	SFF 2631
LX360E (LOADERS) ISUZU 6WG1 , 2006	
Air Filter Secondary.....	SFA 0883S
Fuel Filter.....	SFF 2631
LX450-7 (LOADERS) MITSUBISHI 56A3-Y2TAA1 (S/N: 101-UP) , 2006	
Fuel Filter.....	SFF 9013
LX450-7 (LOADERS) MITSUBISHI 56A3-Y2	
Fuel Filter.....	SFF 6030
LX450-7 (LOADERS) MITSUBISHI 56A3-Y2TAA1	
Oil Filter By Pass.....	SFO 5400
LX50-7 (LOADERS) KUBOTA V3300-DI-KA , 2006	
Air Filter Secondary.....	SFA 2769S
Air Filter Primary.....	SFA 5436P



To order, please call:
+1 8448 BE SURE; +1 (925) 566-8863

For Reference Only - May not be a direct cross



Email :
order@suresfilter.us



Engine Application

MODEL/APPLICATION	SURE NO
HITACHI	
LX70 (LOADERS) ISUZU 4BD1	
Air Filter Secondary.....	SFA 1680S
Air Filter.....	SFA 8172
Hydraulic Oil Filter.....	SFH 7841
LX70-2 (LOADERS) HINO W04CT	
Fuel Filter.....	SFF 2564
LX70-2C (LOADERS) HINO W04CT	
Fuel Filter.....	SFF 2564
LX80 (LOADERS) ISUZU 6BD1	
Fuel Filter.....	SFF 2564
LX80 (LOADERS) ISUZU 6BD1T	
Fuel Filter.....	SFF 2564
LX80 (LOADERS) ISUZU W04DT	
Fuel Filter.....	SFF 2564
LX80-1 (LOADERS) ISUZU 6BD1	
Fuel Filter.....	SFF 2564
LX80-2 (LOADERS) HINO W04D-T	
Fuel Filter.....	SFF 2564
LX80-2 (LOADERS) ISUZU W04D	
Fuel Filter.....	SFF 2564
LX80-2C (LOADERS) HINO W04D-T	
Fuel Filter.....	SFF 2564
PD7 (PILE DRIVERS) HINO D550A	
Air Filter.....	SFA 1045F
Fuel Filter.....	SFF 1040
Oil Filter Full Flow.....	SFO 4754
PD9 (PILE DRIVERS) NISSAN PD604	
Hydraulic Oil Filter.....	SFH 1430
SCX550 (CRANES) ISUZU BB-6HK1-TQA	
Air Filter Primary.....	SFA 1080P
Air Filter Set.....	SFA 9025SET
Fuel Filter.....	SFF 2631
Hydraulic Oil Filter Suction.....	SFH 0224
Hydraulic Oil Filter.....	SFH 3321
Hydraulic Oil Filter.....	SFH 4135
SCX550-3 (CRANES) ISUZU 4HK1	
Air Filter Set.....	SFA 6128SET
Air Filter Primary.....	SFA 6128P
Air Filter Set.....	SFA 61281SET

MODEL/APPLICATION	SURE NO
HITACHI	
SCX550-3 (CRANES) ISUZU 4HK1	
Air Filter Secondary.....	SFA 6130S
Air Filter Primary.....	SFA 61281P
Hydraulic Oil Filter.....	SFH 3321
Hydraulic Oil Filter.....	SFH 6705
Hydraulic Oil Filter.....	SFH 4135
Hydraulic Oil Filter Suction.....	SFH 0224
SCX700 (CRANES) ISUZU BB-6HK1-TQA	
Air Filter Set.....	SFA 9025SET
Air Filter Primary.....	SFA 1080P
Fuel Filter.....	SFF 2631
Hydraulic Oil Filter Suction.....	SFH 0224
Hydraulic Oil Filter.....	SFH 4135
Hydraulic Oil Filter.....	SFH 3321
SCX2800-2 (CRANES) MITSUBISHI 6M70-TL (S/N: TIER 3-UP) , 2008	
Air Filter Primary.....	SFA 1073P
Air Filter Secondary.....	SFA 7313S
Hydraulic Oil Filter.....	SFH 3321
SCX2800-2 (CRANES) w/Mitsubishi 6M70-TL Eng. (Tier 3)	
Air Filter Set.....	SFA 24901SET
SCX400 (CRANES) ISUZU 6HK1	
Hydraulic Oil Filter.....	SFH 6705
SCX400 (CRANES) ISUZU BB-6HK1-TQA	
Air Filter Primary.....	SFA 1080P
Air Filter Set.....	SFA 9025SET
Fuel Filter.....	SFF 2631
Hydraulic Oil Filter.....	SFH 3321
Hydraulic Oil Filter Suction.....	SFH 0224
Hydraulic Oil Filter.....	SFH 4135
SCX900 (CRANES) MITSUBISHI 6D24T	
Air Filter Secondary.....	SFA 9373S
Air Filter Primary.....	SFA 1046P
Hydraulic Oil Filter.....	SFH 4135
Hydraulic Oil Filter.....	SFH 3321
SCX900-2 (CRANES) MITSUBISHI 6D24T (S/N: 000101-UP) , 2004	
Air Filter Primary.....	SFA 31302P
Air Filter Primary.....	SFA 3130P
Air Filter Set.....	SFA 6070SET
Hydraulic Oil Filter.....	SFH 3321
T012 (LOADERS) HITACHI B60B	
Air Filter.....	SFA 1035
Air Filter.....	SFA 1035F
Fuel Filter Secondary.....	SFF 0404
T09 (LOADERS) HITACHI B40B	

MODEL/APPLICATION	SURE NO
HITACHI	
T09 (LOADERS) HITACHI B40B	
Air Filter.....	SFA 1045F
Fuel Filter Secondary.....	SFF 0404
T113 (LOADERS)	
Fuel Filter Secondary.....	SFF 0404
TS015B (LOADERS) HITACHI K60	
Air Filter.....	SFA 1035F
Air Filter.....	SFA 1035
Fuel Filter Secondary.....	SFF 0404
U106 (CRANES)	
Air Filter.....	SFA 1045F
Fuel Filter Secondary.....	SFF 0404
Fuel Filter Primary.....	SFF 3811
UE004 (EXCAVATORS) HITACHI MMC K3B	
Air Filter.....	SFA 2745PF
Oil Filter Full Flow.....	SFO 4302
UE005 (EXCAVATORS) HITACHI MMC K3E	
Oil Filter Full Flow.....	SFO 4302
UE005 (EXCAVATORS) MITSUBISHI K3E	
Fuel Filter.....	SFS 4900
UE008 (EXCAVATORS) HITACHI MMC K4E	
Oil Filter Full Flow.....	SFO 0535
UE014 (EXCAVATORS) NISSAN	
Air Filter Primary.....	SFA 1052PF
Oil Filter Full Flow.....	SFO 7502
UE10 (EXCAVATORS) HITACHI MMC K3B	
Air Filter.....	SFA 2745PF
Oil Filter Full Flow.....	SFO 4302
Oil Filter Full Flow.....	SFO 1420
UE15 (EXCAVATORS) ISUZU 3KB1	
Air Filter.....	SFA 2745PF
UE20 (EXCAVATORS) HITACHI MMC K3E	
Air Filter.....	SFA 2745PF
Oil Filter Full Flow.....	SFO 4302
Oil Filter Full Flow.....	SFO 0535
Oil Filter Full Flow.....	SFO 1420
UE30 (EXCAVATORS) HITACHI MMC K4E	
Oil Filter Full Flow.....	SFO 0535
UE30 (EXCAVATORS) MITSUBISHI K4E	



To order, please call:
+1 8448 BE SURE; +1 (925) 566-8863

For Reference Only - May not be a direct cross



Email :
order@surefilter.us



Engine Application

MODEL/APPLICATION	SURE NO
HITACHI	
UE30 (EXCAVATORS) MITSUBISHI K4E Fuel Filter.....	SFS 4900
UE50 (EXCAVATORS) ISUZU 4JC1 Air Filter Primary..... Fuel Filter..... Oil Filter Full Flow..... Oil Filter Full Flow.....	SFA 1052PF SFF 0009 SFO 178A SFO 9708
UE50 (EXCAVATORS) NISSAN Air Filter Primary..... Fuel Filter..... Oil Filter Full Flow..... Oil Filter Full Flow.....	SFA 1052PF SFF 0009 SFO 178A SFO 9708 SFO 7502
UH003 (EXCAVATORS) HITACHI Z600-K1 Fuel Filter.....	SFF 3563
UH004 (EXCAVATORS) HITACHI D850BH Fuel Filter.....	SFF 3390
UH005 (EXCAVATORS) HITACHI D950BH Air Filter Primary..... Fuel Filter.....	SFA 1050PF SFF 3563
UH006 (EXCAVATORS) HITACHI D1302BH Air Filter Primary..... Fuel Filter.....	SFA 1050PF SFF 3390
UH02 (EXCAVATORS) ISUZU C330 Air Filter Set..... Air Filter Primary..... Air Filter Primary..... Air Filter Primary..... Oil Filter Full Flow.....	SFA 1054PSET SFA 1052PF SFA 1054PF SFA 1054P SFO 1940
UH025 (EXCAVATORS) ISUZU 4BBL Air Filter Primary..... Oil Filter Full Flow.....	SFA 1052PF SFO 1940
UH025-7 (EXCAVATORS) ISUZU FD3304 Air Filter Primary..... Oil Filter Full Flow.....	SFA 1052PF SFO 9005
UH025-7 (EXCAVATORS) NISSAN FD3304 Fuel Filter.....	SFF 0057
UH03 (EXCAVATORS) ISUZU DA220 Air Filter Primary..... Fuel Filter..... Oil Filter Full Flow.....	SFA 1052PF SFF 1010 SFO 3264

MODEL/APPLICATION	SURE NO
HITACHI	
UH03 (EXCAVATORS) ISUZU 4BB1 Hydraulic Oil Filter.....	SFH 2410
UH03-1 (EXCAVATORS) ISUZU 4BB1 Air Filter Primary..... Oil Filter Full Flow.....	SFA 1052PF SFO 1940
UH03-3 (EXCAVATORS) HITACHI FD3304 (S/N: 5501-UP) Air Filter Primary.....	SFA 1052PF
UH03-3 (EXCAVATORS) ISUZU 4BB1 Air Filter Primary..... Fuel Filter..... Oil Filter Full Flow.....	SFA 1052PF SFF 0057 SFO 1940
UH03-3 (EXCAVATORS) NISSAN FD3304 Fuel Filter.....	SFF 0057
UH0357 (EXCAVATORS) HITACHI 4BBL Oil Filter Full Flow.....	SFO 3853
UH03M-2 (EXCAVATORS) HINO EC100A Air Filter Set..... Air Filter Primary..... Air Filter Primary..... Fuel Filter.....	SFA 1054PSET SFA 1054PF SFA 1054P SFF 1010
UH04 (EXCAVATORS) HINO EC100 Air Filter Primary..... Air Filter Set..... Air Filter Primary..... Fuel Filter..... Oil Filter Full Flow.....	SFA 1054PF SFA 1054PSET SFA 1054P SFF 1010 SFO 4754
UH04 (EXCAVATORS) ISUZU 6BBL Air Filter Primary..... Air Filter Set..... Air Filter Primary..... Fuel Filter..... Oil Filter Full Flow..... Oil Filter Full Flow.....	SFA 1054P SFA 1054PSET SFA 1054PF SFF 1010 SFO 4754 SFO 1940
UH041 (EXCAVATORS) ISUZU 4BB1 Air Filter Primary..... Hydraulic Oil Filter..... Oil Filter Full Flow.....	SFA 1052PF SFH 2410 SFO 1940
UH043 (EXCAVATORS) ISUZU 4BB1 Air Filter Primary..... Fuel Filter..... Hydraulic Oil Filter..... Hydraulic Oil Filter..... Oil Filter Full Flow.....	SFA 1052PF SFF 6130 SFH 0987 SFH 0403 SFO 3853

MODEL/APPLICATION	SURE NO
HITACHI	
UH043 (EXCAVATORS) ISUZU 4BB1 Oil Filter Full Flow.....	SFO 1940
UH045-1 (EXCAVATORS) ISUZU 6BD1 Air Filter Primary..... Air Filter Set..... Air Filter Primary..... Fuel Filter.....	SFA 1054P SFA 1054PSET SFA 1054PF SFF 1010
UH045-7 (EXCAVATORS) HITACHI 6BBL Fuel Filter..... Oil Filter Full Flow.....	SFF 1010 SFO 4754
UH045-7 (EXCAVATORS) ISUZU 6BB1 Fuel Filter.....	SFF 2564
UH045-7 (EXCAVATORS) ISUZU 6BD1 Fuel Filter.....	SFF 2564
UH04-7 (EXCAVATORS) ISUZU 4BBL Air Filter Set..... Air Filter Primary..... Hydraulic Oil Filter..... Oil Filter Full Flow.....	SFA 6099SET SFA 6099P SFH 7353 SFO 1940
UH05 (EXCAVATORS) ISUZU 6BBL Fuel Filter.....	SFF 1010
UH051 (EXCAVATORS) ISUZU 6BB1 Air Filter Set..... Air Filter Primary..... Air Filter Primary..... Fuel Filter..... Hydraulic Oil Filter..... Oil Filter Full Flow.....	SFA 1054PSET SFA 1054PF SFA 1054P SFF 1010 SFH 7353 SFO 1940
UH051D (EXCAVATORS) Air Filter Primary..... Air Filter Primary..... Air Filter Set..... Fuel Filter..... Hydraulic Oil Filter..... Oil Filter Full Flow.....	SFA 1054PF SFA 1054P SFA 1054PSET SFF 1010 SFH 7353 SFO 4754
UH052 (EXCAVATORS) ISUZU 6BB1 Air Filter Primary..... Air Filter Primary..... Air Filter Set..... Fuel Filter..... Hydraulic Oil Filter..... Oil Filter Full Flow.....	SFA 1054P SFA 1054PF SFA 1054PSET SFF 1010 SFH 7353 SFO 1940
UH053 (EXCAVATORS) ISUZU 4BD1	



To order, please call:
+1 8448 BE SURE; +1 (925) 566-8863

For Reference Only - May not be a direct cross

A 15



Email :
order@suresfilter.us



Engine Application

MODEL/APPLICATION	SURE NO
HITACHI	

UH053 (EXCAVATORS) ISUZU 4BD1	
Fuel Filter.....	SFF 1010
Fuel Filter.....	SFF 6130
Hydraulic Oil Filter.....	SFH 0987
Oil Filter Full Flow.....	SFO 1940
Oil Filter Full Flow.....	SFO 3853

UH06 (EXCAVATORS) DAF	
Air Filter Primary.....	SFA 1054PF
Air Filter Set.....	SFA 1054PSET
Air Filter Primary.....	SFA 1054P
Hydraulic Oil Filter.....	SFH 2410

UH06 (EXCAVATORS) ISUZU DA640	
Air Filter Primary.....	SFA 1054PF
Air Filter Set.....	SFA 1054PSET
Air Filter Primary.....	SFA 1054P
Fuel Filter.....	SFF 1010
Hydraulic Oil Filter.....	SFH 0409
Hydraulic Oil Filter.....	SFH 2410
Oil Filter Full Flow.....	SFO 3265

UH061 (EXCAVATORS) ISUZU 6BD1	
Air Filter Primary.....	SFA 1054P
Air Filter Primary.....	SFA 1046P
Air Filter Set.....	SFA 1054PSET
Air Filter Primary.....	SFA 1054PF
Fuel Filter.....	SFF 1010
Hydraulic Oil Filter.....	SFH 7353
Oil Filter Full Flow.....	SFO 4754
Oil Filter Full Flow.....	SFO 1940

UH063 (EXCAVATORS) ISUZU 6BB1	
Fuel Filter.....	SFF 2564

UH063 (EXCAVATORS) ISUZU 6BD1	
Fuel Filter.....	SFF 0052
Fuel Filter.....	SFF 1010
Hydraulic Oil Filter.....	SFH 0987
Oil Filter Full Flow.....	SFO 4754

UH06-5 (EXCAVATORS) ISUZU 6BD1	
Air Filter Primary.....	SFA 1054P
Air Filter Set.....	SFA 1054PSET
Air Filter Primary.....	SFA 1054PF
Fuel Filter.....	SFF 1010
Hydraulic Oil Filter.....	SFH 0409

UH06DT (EXCAVATORS) PERKINS 6.354	
Fuel Filter.....	SFF 0522
Oil Filter Full Flow.....	SFO 4407

UH07 (EXCAVATORS) ISUZU DA640	
Hydraulic Oil Filter.....	SFH 2410

MODEL/APPLICATION	SURE NO
HITACHI	

UH07 (EXCAVATORS) ISUZU DA640	
Hydraulic Oil Filter.....	SFH 0409

UH071 (EXCAVATORS) ISUZU 6BD1	
Hydraulic Oil Filter.....	SFH 2410

UH073 (EXCAVATORS) HINO D550	
Hydraulic Oil Filter.....	SFH 0409

UH073 (EXCAVATORS) ISUZU 6BB1	
Fuel Filter.....	SFF 1010
Fuel Filter.....	SFF 2564
Fuel Filter.....	SFF 0052
Oil Filter Full Flow.....	SFO 4754

UH07-5 (EXCAVATORS) HINO EL100	
Air Filter.....	SFA 1045F
Hydraulic Oil Filter.....	SFH 0409
Hydraulic Oil Filter.....	SFH 7353
Oil Filter Full Flow.....	SFO 4754

UH07-7 (EXCAVATORS) ISUZU 6BD1T	
Air Filter Primary.....	SFA 3113P
Air Filter Set.....	SFA 6050SET
Fuel Filter.....	SFF 0052
Fuel Filter.....	SFF 2564
Hydraulic Oil Filter.....	SFH 0409
Hydraulic Oil Filter.....	SFH 7353

UH07LC (EXCAVATORS) HINO EL100	
Hydraulic Oil Filter.....	SFH 0409

UH07LC-5 (EXCAVATORS) HINO EL100	
Air Filter Primary.....	SFA 3113P
Air Filter Set.....	SFA 6050SET
Fuel Filter.....	SFF 1040
Hydraulic Oil Filter.....	SFH 0409
Oil Filter Full Flow.....	SFO 4754

UH07S (EXCAVATORS) HINO EL100	
Hydraulic Oil Filter.....	SFH 0409

UH07S-5 (EXCAVATORS) HINO EL100	
Hydraulic Oil Filter.....	SFH 0409

UH08 (EXCAVATORS) HINO EL100	
Fuel Filter.....	SFF 1040
Oil Filter Full Flow.....	SFO 4754

UH081 (EXCAVATORS) HINO EL100	
Air Filter.....	SFA 1045F
Hydraulic Oil Filter.....	SFH 0409
Hydraulic Oil Filter.....	SFH 7353

MODEL/APPLICATION	SURE NO
HITACHI	

UH081 (EXCAVATORS) HINO EL100	
Oil Filter Full Flow.....	SFO 4754

UH082 (EXCAVATORS)	
Air Filter.....	SFA 1045F
Oil Filter Full Flow.....	SFO 4754

UH083 (EXCAVATORS) ISUZU 6BD1	
Air Filter Set.....	SFA 6050SET
Air Filter Primary.....	SFA 3113P
Air Filter Secondary.....	SFA 0490S
Fuel Filter.....	SFF 1010
Fuel Filter.....	SFF 2564
Fuel Filter.....	SFF 0052
Hydraulic Oil Filter.....	SFH 7353
Hydraulic Oil Filter.....	SFH 0987
Oil Filter By Pass.....	SFO 3601
Oil Filter Full Flow.....	SFO 4754

UH083 (EXCAVATORS) ISUZU 6DD1	
Fuel Filter.....	SFF 2564

UH083LC (EXCAVATORS) ISUZU 6BD1T	
Fuel Filter.....	SFF 2564

UH083LC (EXCAVATORS) ISUZU 6BD1T	
Air Filter Primary.....	SFA 3113P
Air Filter Set.....	SFA 6050SET
Fuel Filter.....	SFF 0052

UH09 (EXCAVATORS) HINO D550	
Air Filter Set.....	SFA 1054PSET
Air Filter Primary.....	SFA 1054P
Air Filter Primary.....	SFA 1054PF
Air Filter.....	SFA 1045F
Fuel Filter.....	SFF 1040
Hydraulic Oil Filter.....	SFH 0409
Oil Filter Full Flow.....	SFO 4754
Oil Filter By Pass.....	SFO 3601

UH09-2 (EXCAVATORS) HINO EL100	
Air Filter.....	SFA 1045F
Fuel Filter.....	SFF 1040
Hydraulic Oil Filter.....	SFH 0409
Hydraulic Oil Filter.....	SFH 7353
Oil Filter Full Flow.....	SFO 4754

UH09-7 (EXCAVATORS) HINO EM100	
Air Filter Primary.....	SFA 1080P
Air Filter Set.....	SFA 9025SET
Hydraulic Oil Filter.....	SFH 0409
Hydraulic Oil Filter.....	SFH 7353



To order, please call:
+1 8448 BE SURE; +1 (925) 566-8863

For Reference Only - May not be a direct cross



Email :
order@suresfilter.us



Engine Application

MODEL/APPLICATION	SURE NO
HITACHI	
UH04-5 (EXCAVATORS) ISUZU 6BBL	
Fuel Filter.....	SFF 1010
Hydraulic Oil Filter.....	SFH 7353
Oil Filter Full Flow.....	SFO 1940
UH07-3 (EXCAVATORS) HINO D550A	
Air Filter Primary.....	SFA 1054P
Air Filter Primary.....	SFA 1054PF
Air Filter Set.....	SFA 1054PSET
Fuel Filter.....	SFF 1040
Oil Filter Full Flow.....	SFO 4754
UH033 (EXCAVATORS) ISUZU 48B1	
Hydraulic Oil Filter.....	SFH 2410
UH033 (EXCAVATORS) NISSAN FD3304	
Hydraulic Oil Filter.....	SFH 0403
UH031 (EXCAVATORS) ISUZU 48B1	
Hydraulic Oil Filter.....	SFH 2410
UH10 (EXCAVATORS) ISUZU 120	
Air Filter Primary.....	SFA 0418P
Fuel Filter.....	SFF 1010
Hydraulic Oil Filter.....	SFH 7353
Oil Filter Full Flow.....	SFO 3265
UH10 (EXCAVATORS) ISUZU E120	
Hydraulic Oil Filter.....	SFH 0409
UH101 (EXCAVATORS) HINO E1100	
Air Filter.....	SFA 1045F
Hydraulic Oil Filter.....	SFH 0409
Hydraulic Oil Filter.....	SFH 2410
Oil Filter Full Flow.....	SFO 4754
UH103 (EXCAVATORS) HINO EM100	
Air Filter Secondary.....	SFA 7315S
Air Filter Primary.....	SFA 1080P
Air Filter Set.....	SFA 9025SET
Fuel Filter.....	SFF 2390
Hydraulic Oil Filter.....	SFH 7353
Oil Filter Full Flow.....	SFO 4754
UH10-7 (EXCAVATORS) HINO EM100	
Hydraulic Oil Filter.....	SFH 0409
UH12 (EXCAVATORS) HITACHI B60	
Air Filter Primary.....	SFA 0418P
Hydraulic Oil Filter.....	SFH 0409
UH12 (EXCAVATORS) HITACHI K60	
Air Filter Primary.....	SFA 0418P

MODEL/APPLICATION	SURE NO
HITACHI	
UH12 (EXCAVATORS) HITACHI K60	
UH12 (EXCAVATORS) ISUZU E120	
Fuel Filter.....	SFF 0027
Oil Filter Full Flow.....	SFO 3265
UH12 (EXCAVATORS) ISUZU EP100	
Air Filter Set.....	SFA 9025SET
Air Filter Primary.....	SFA 1080P
Fuel Filter.....	SFF 2390
Hydraulic Oil Filter.....	SFH 7353
UH121 (EXCAVATORS) ISUZU E120	
Air Filter Primary.....	SFA 0418P
Fuel Filter.....	SFF 0027
Hydraulic Oil Filter.....	SFH 2410
Hydraulic Oil Filter.....	SFH 0409
Hydraulic Oil Filter.....	SFH 65561
Oil Filter Full Flow.....	SFO 3265
UH122 (EXCAVATORS)	
Air Filter Primary.....	SFA 0418P
Fuel Filter.....	SFF 0027
Oil Filter Full Flow.....	SFO 3265
UH123 (EXCAVATORS) HINO EM100	
Air Filter Secondary.....	SFA 7315S
Air Filter Set.....	SFA 9025SET
Air Filter Primary.....	SFA 1080P
Hydraulic Oil Filter.....	SFH 0987
Hydraulic Oil Filter.....	SFH 7353
UH14 (EXCAVATORS) DETROITD 6-71	
Air Filter Primary.....	SFA 0418P
Fuel Filter Primary.....	SFF 6915
Fuel Filter Secondary.....	SFF 6916
Oil Filter Full Flow.....	SFO 0132
UH14 (EXCAVATORS) ISUZU E120	
Air Filter Primary.....	SFA 0418P
Air Filter.....	SFA 1240F
Fuel Filter.....	SFF 0027
Fuel Filter.....	SFF 1010
Hydraulic Oil Filter.....	SFH 0409
Hydraulic Oil Filter.....	SFH 7353
Oil Filter Full Flow.....	SFO 3265
UH143 (EXCAVATORS) HITACHI EP100	
Air Filter Primary.....	SFA 2530P
Air Filter Set.....	SFA 8600SET
Air Filter Secondary.....	SFA 4046S
Fuel Filter.....	SFF 2390
Hydraulic Oil Filter.....	SFH 7353
Oil Filter By Pass.....	SFO 2777

MODEL/APPLICATION	SURE NO
HITACHI	
UH143LC (EXCAVATORS) HINO	
Air Filter Set.....	SFA 8600SET
Air Filter Primary.....	SFA 2530P
Air Filter Secondary.....	SFA 4046S
Fuel Filter.....	SFF 105N
Oil Filter By Pass.....	SFO 2777
UH17 (EXCAVATORS) ISUZU E120	
Fuel Filter.....	SFF 0027
Oil Filter Full Flow.....	SFO 3265
UH171 (EXCAVATORS) ISUZU E120	
Air Filter.....	SFA 1240F
Fuel Filter.....	SFF 1010
Fuel Filter.....	SFF 0027
Hydraulic Oil Filter.....	SFH 0409
Hydraulic Oil Filter.....	SFH 7353
Oil Filter Full Flow.....	SFO 3265
Oil Filter By Pass.....	SFO 2777
UH181 (EXCAVATORS) ISUZU 6RB1	
Air Filter Primary.....	SFA 1046P
Air Filter Secondary.....	SFA 9373S
Fuel Filter.....	SFF 0027
Fuel Filter.....	SFF 2631
Hydraulic Oil Filter.....	SFH 7353
Hydraulic Oil Filter.....	SFH 0409
Oil Filter Full Flow.....	SFO 0105
Oil Filter Full Flow.....	SFO 3265
UH181 (EXCAVATORS) ISUZU E120	
Hydraulic Oil Filter.....	SFH 65561
UH172 (EXCAVATORS)	
Hydraulic Oil Filter.....	SFH 7353
UH122LC (EXCAVATORS) ISUZU E120	
Hydraulic Oil Filter.....	SFH 2410
UH20 (EXCAVATORS) ISUZU E120	
Hydraulic Oil Filter.....	SFH 0409
UH20 (EXCAVATORS) ISUZU E120(2)	
Air Filter Primary.....	SFA 0418P
Fuel Filter.....	SFF 0027
Hydraulic Oil Filter.....	SFH 7353
Oil Filter Full Flow.....	SFO 3265
UH23 (EXCAVATORS) ISUZU 6RB1	
Hydraulic Oil Filter.....	SFH 0409
UH23 (EXCAVATORS) ISUZU E120 (QTY 2)	
Air Filter Primary.....	SFA 0418P



To order, please call:
+1 8448 BE SURE; +1 (925) 566-8863

For Reference Only - May not be a direct cross

A 17



Email :
order@surefilter.us



Engine Application

MODEL/APPLICATION	SURE NO
HITACHI	
UH23 (EXCAVATORS) ISUZU E120 (QTY 2)	
Air Filter.....	SFA 1240F
Fuel Filter.....	SFF 0027
Hydraulic Oil Filter.....	SFH 7353
Oil Filter Full Flow.....	SFO 3265
UH261 (EXCAVATORS) HITACHI	
Hydraulic Oil Filter.....	SFH 65561
UH261 (EXCAVATORS) ISUZU E120	
Air Filter Secondary.....	SFA 0490S
Air Filter Primary.....	SFA 0418P
Fuel Filter.....	SFF 2631
Fuel Filter.....	SFF 0027
Hydraulic Oil Filter.....	SFH 7353
Oil Filter Full Flow.....	SFO 3265
Oil Filter Full Flow.....	SFO 0105
UH30 (EXCAVATORS) ISUZU E120	
Hydraulic Oil Filter.....	SFH 0409
UH30 (EXCAVATORS)	
Air Filter.....	SFA 1240F
Fuel Filter.....	SFF 0027
Hydraulic Oil Filter.....	SFH 7353
Oil Filter Full Flow.....	SFO 3265
UH43 (EXCAVATORS) HITACHI 4BB1	
Air Filter Primary.....	SFA 1052PF
Fuel Filter.....	SFF 6130
Hydraulic Oil Filter.....	SFH 0987
Oil Filter Full Flow.....	SFO 3853
UH53 (EXCAVATORS) HITACHI 4BD1	
Fuel Filter.....	SFF 1010
Fuel Filter.....	SFF 6130
Hydraulic Oil Filter.....	SFH 0987
Oil Filter Full Flow.....	SFO 3853
UH52 (EXCAVATORS) ISUZU 6BBL , 1975	
Fuel Filter.....	SFF 1010
Oil Filter Full Flow.....	SFO 4754
UH501 (EXCAVATORS) HITACHI	
Hydraulic Oil Filter.....	SFH 65561
UH62 (EXCAVATORS) ISUZU 6BD1	
Fuel Filter.....	SFF 1010
Oil Filter Full Flow.....	SFO 4754
UH80 (EXCAVATORS) CUMMINS KT-1150 (QTY 2)	
Coolant Filter.....	SFW 2071
Fuel Filter.....	SFF 0105D

MODEL/APPLICATION	SURE NO
HITACHI	
UH80 (EXCAVATORS) CUMMINS KT-1150 (QTY 2)	
Oil Filter By Pass.....	SFO 2777
Oil Filter By Pass.....	SFO 5050
Oil Filter Full Flow.....	SFO 2670
UH801 (EXCAVATORS) CUMMINS KT-1150 (QTY 2)	
Air Filter Secondary.....	SFA 9373S
Air Filter Primary.....	SFA 1046P
Coolant Filter.....	SFW 2071
Fuel Filter.....	SFF 0105D
Hydraulic Oil Filter.....	SFH 7353
Oil Filter Full Flow.....	SFO 2670
Oil Filter By Pass.....	SFO 2777
Oil Filter By Pass.....	SFO 5050
UH801 (EXCAVATORS) HITACHI	
Hydraulic Oil Filter.....	SFH 65561
UH81 (EXCAVATORS) HINO EL100	
Hydraulic Oil Filter.....	SFH 7353
Oil Filter Full Flow.....	SFO 4754
UHM14 (EXCAVATORS) HITACHI D1301BH	
Air Filter Primary.....	SFA 1050PF
Fuel Filter.....	SFF 3390
WH03 (EXCAVATORS) ISUZU DA220	
Air Filter Primary.....	SFA 1052PF
Fuel Filter.....	SFF 1010
Oil Filter Full Flow.....	SFO 3264
WH04 (EXCAVATORS) ISUZU 6BB1	
Air Filter Primary.....	SFA 1054PF
Air Filter Primary.....	SFA 1052PF
Air Filter Set.....	SFA 1054PSET
Air Filter Primary.....	SFA 1054P
Fuel Filter.....	SFF 1010
Oil Filter Full Flow.....	SFO 1940
WH04 (EXCAVATORS) ISUZU 6BBL	
Air Filter Primary.....	SFA 1054P
Air Filter Primary.....	SFA 1054PF
Air Filter Set.....	SFA 1054PSET
Fuel Filter.....	SFF 1010
Oil Filter Full Flow.....	SFO 1940
WH051 (EXCAVATORS) ISUZU 6BBL	
Fuel Filter.....	SFF 1010
Oil Filter Full Flow.....	SFO 4754
WH051D (EXCAVATORS) ISUZU 6BB1	
Air Filter Primary.....	SFA 1054P
Air Filter Primary.....	SFA 1054PF
Air Filter Set.....	SFA 1054PSET

MODEL/APPLICATION	SURE NO
HITACHI	
WH051D (EXCAVATORS) ISUZU 6BB1	
Fuel Filter.....	SFF 1010
Hydraulic Oil Filter.....	SFH 7353
Oil Filter Full Flow.....	SFO 4754
WH052 (EXCAVATORS) ISUZU 6BB1	
Air Filter Primary.....	SFA 1054PF
Air Filter Primary.....	SFA 1054P
Air Filter Set.....	SFA 1054PSET
Fuel Filter.....	SFF 1010
Hydraulic Oil Filter.....	SFH 7353
Oil Filter Full Flow.....	SFO 1940
WH073D (EXCAVATORS) ISUZU 6BD1	
Fuel Filter.....	SFF 1010
Hydraulic Oil Filter.....	SFH 7353
Oil Filter Full Flow.....	SFO 4754
WH801 (EXCAVATORS) CUMMINS KTAA1150	
Air Filter Secondary.....	SFA 9373S
Coolant Filter.....	SFW 2075
Fuel Filter.....	SFF 105N
Oil Filter Full Flow.....	SFO 2670
Oil Filter By Pass.....	SFO 5050
ZAXIS 85 USB-5A (EXCAVATORS) YANMAR 4TNV94L , 3000, 2013	
Hydraulic Oil Filter.....	SFH 7425
ZW140 (LOADERS) CUMMINS Q5B4.5	
Hydraulic Oil Filter.....	SFH 2011
ZW180 (LOADERS) CUMMINS Q5B6.7 , 2007	
Air Filter Secondary.....	SFA 8813S
Fuel/Water Separator.....	SFR 9732FW
Oil Filter Full Flow.....	SFO 3937
ZW220 - 00101 (LOADERS) ISUZU ISUZU , 2006	
Air Filter Set.....	SFA 0022SET
Air Filter Primary.....	SFA 0022PF
ZW250 - 00101 (LOADERS) ISUZU ISUZU , 2006	
Air Filter Primary.....	SFA 0022PF
Air Filter Set.....	SFA 0022SET
ZW220 (LOADERS) ISUZU 6HK1	
Hydraulic Oil Filter.....	SFH 8651
ZW220 (LOADERS) ISUZU 6WG1	
Hydraulic Oil Filter.....	SFH 8651
ZW250 (LOADERS) ISUZU (S/N: 00101-UP) , 2006	
Air Filter Primary.....	SFA 0022PF
Air Filter Set.....	SFA 0022SET



To order, please call:
+1 8448 BE SURE; +1 (925) 566-8863

For Reference Only - May not be a direct cross



Email :
order@suresfilter.us



Engine Application

MODEL/APPLICATION	SURE NO
HITACHI	
ZW250 (LOADERS) ISUZU (S/N: 00101-UP) , 2006	
Air Filter Secondary.....	SFA 8813S
Hydraulic Oil Filter Transmission..	SFH 4729
ZW250 (LOADERS) ISUZU AH-6HK1X	
Cabin Air Filter.....	SFC 58237
ZW250 (LOADERS) ISUZU 6HK1	
Hydraulic Oil Filter.....	SFH 8651
ZW250 (LOADERS) ISUZU 6WG1	
Hydraulic Oil Filter.....	SFH 8651
ZW310 (LOADERS) DAIMLERB OM460LA (S/N: 00101-UP) , 2006	
Air Filter Primary.....	SFA 5702P
Air Filter Secondary.....	SFA 9372S
Fuel/Water Separator.....	SFR 9001FW
Fuel/Water Separator.....	SFR 9001FWB
ZW310 (LOADERS) MERCEDES-BENZ OM 460 LA	
Hydraulic Oil Filter.....	SFH 8651
ZX110-3 (EXCAVATORS) ISUZU 4J-4JJ1X , 2008	
Cabin Air Filter.....	SFC 32689
Cabin Air Filter.....	SFC 32683
ZX110-3 (EXCAVATORS) ISUZU AJ-4JJ1X	
Cabin Air Filter.....	SFC 50249
Cabin Air Filter.....	SFC 43580
Oil Filter Combination.....	SFO 8336
ZX110 (EXCAVATORS) ISUZU 4BG1 TRG	
Air Filter Primary.....	SFA 8889P
Air Filter Secondary.....	SFA 5485S
Air Filter Primary.....	SFA 77251P
Air Filter Primary.....	SFA 88891P
Air Filter Set.....	SFA 88891SET
Air Filter Secondary.....	SFA 8238S
Fuel Filter.....	SFF 6280
Fuel Filter.....	SFF 2001
Hydraulic Oil Filter.....	SFH 5577
Hydraulic Oil Filter.....	SFH 7841
ZX110 (EXCAVATORS) ISUZU BB-4BG1T	
Cabin Air Filter.....	SFC 50249
ZX110 (EXCAVATORS) w/Isuzu BB-4BG1T Eng.	
Cabin Air Filter.....	SFC 00684
Oil Filter Combination.....	SFO 8336
ZX110-E (EXCAVATORS) ISUZU 4BG1	
Fuel Filter.....	SFF 0057

MODEL/APPLICATION	SURE NO
HITACHI	
ZX110-E (EXCAVATORS) ISUZU 4BG1T	
Cabin Air Filter.....	SFC 00684
Cabin Air Filter.....	SFC 50249
Oil Filter Combination.....	SFO 8336
ZX110-E (EXCAVATORS) ISUZU 4BG1 TRG	
Hydraulic Oil Filter.....	SFH 5577
ZX110M (EXCAVATORS) ISUZU 4BG1	
Fuel Filter.....	SFF 0057
ZX110M (EXCAVATORS) ISUZU 4BG1T	
Cabin Air Filter.....	SFC 00684
Cabin Air Filter.....	SFC 50249
Fuel Filter.....	SFF 0057
Oil Filter Combination.....	SFO 8336
ZX110M (EXCAVATORS) ISUZU 4BG1 TRG	
Hydraulic Oil Filter.....	SFH 5577
ZX120 (EXCAVATORS) ISUZU CC-4BG1T	
Hydraulic Oil Filter.....	SFH 5577
ZX120 (EXCAVATORS) ISUZU 4BG1T	
Air Filter Set.....	SFA 88891SET
Air Filter Secondary.....	SFA 5485S
Air Filter Primary.....	SFA 77251P
Air Filter Secondary.....	SFA 8238S
Air Filter Primary.....	SFA 8889P
Air Filter Primary.....	SFA 88891P
Cabin Air Filter.....	SFC 00684
Cabin Air Filter.....	SFC 50249
Fuel Filter.....	SFF 6280
Hydraulic Oil Filter.....	SFH 7841
Oil Filter Combination.....	SFO 8336
ZX120-3 (EXCAVATORS) ISUZU 4JJ1X	
Cabin Air Filter.....	SFC 43580
ZX120-3 (EXCAVATORS) ISUZU AJ-4JJ1XYSA-03	
Hydraulic Oil Filter.....	SFH 5577
ZX120-E (EXCAVATORS) ISUZU 4BG1T	
Cabin Air Filter.....	SFC 00684
Cabin Air Filter.....	SFC 50249
Oil Filter Combination.....	SFO 8336
ZX125 (EXCAVATORS) S/N: 10572-UP	
Air Filter Primary.....	SFA 88891P
Air Filter Secondary.....	SFA 5485S
Air Filter Primary.....	SFA 77251P
Air Filter Primary.....	SFA 8889P
Air Filter Set.....	SFA 88891SET

MODEL/APPLICATION	SURE NO
HITACHI	
ZX125 (EXCAVATORS) S/N: 10572-UP	
Fuel Filter.....	SFF 6280
Fuel Filter.....	SFF 2001
Hydraulic Oil Filter.....	SFH 7841
ZX125 (EXCAVATORS) S/N: TO-10571	
Air Filter Secondary.....	SFA 8238S
Hydraulic Oil Filter.....	SFH 7841
ZX125US-E (EXCAVATORS) ISUZU 4BG1T	
Cabin Air Filter.....	SFC 50249
Hydraulic Oil Filter.....	SFH 5577
Oil Filter Combination.....	SFO 8336
ZX125US-E (EXCAVATORS) ISUZU 4BG1T (S/N: 001001-UP)	
Air Filter Secondary.....	SFA 8238S
Air Filter Primary.....	SFA 8889P
Air Filter Secondary.....	SFA 5485S
Air Filter Primary.....	SFA 77251P
Air Filter Primary.....	SFA 88891P
Air Filter Set.....	SFA 88891SET
Fuel Filter.....	SFF 6280
Hydraulic Oil Filter.....	SFH 7841
ZX130 (EXCAVATORS) ISUZU CC-4BG1TC	
Cabin Air Filter.....	SFC 50249
ZX130 (EXCAVATORS) S/N: 60138-UP	
Air Filter Primary.....	SFA 88891P
Air Filter Secondary.....	SFA 5485S
Air Filter Primary.....	SFA 77251P
Air Filter Set.....	SFA 88891SET
Air Filter Primary.....	SFA 8889P
Fuel Filter.....	SFF 2001
Fuel Filter.....	SFF 6280
Hydraulic Oil Filter.....	SFH 7841
ZX130 (EXCAVATORS) S/N: TO-60137	
Air Filter Secondary.....	SFA 8238S
Air Filter Primary.....	SFA 6098P
Air Filter Set.....	SFA 6098SET
Fuel Filter.....	SFF 6280
Fuel Filter.....	SFF 2001
Hydraulic Oil Filter.....	SFH 7841
ZX130 (EXCAVATORS) W/ISUZU CC-4BG1TC Eng.	
Cabin Air Filter.....	SFC 00684
Oil Filter Combination.....	SFO 8336
ZX130H (EXCAVATORS) ISUZU 4BG1T	
Cabin Air Filter.....	SFC 00684
Cabin Air Filter.....	SFC 50249
Oil Filter Combination.....	SFO 8336



To order, please call:
+1 8448 BE SURE; +1 (925) 566-8863

For Reference Only - May not be a direct cross



Email :
order@suresfilter.us



Engine Application

MODEL/APPLICATION	SURE NO
-------------------	---------

HITACHI	
ZX130K (EXCAVATORS) ISUZU 4BG1T	
Cabin Air Filter.....	SFC 00684
Oil Filter Combination.....	SFO 8336
ZX130LCN-3 (EXCAVATORS) ISUZU AJ-4JJ1X	
Cabin Air Filter.....	SFC 43580
Cabin Air Filter.....	SFC 50249
Oil Filter Combination.....	SFO 8336
ZX130W (EXCAVATORS) ISUZU 4BG1T	
Air Filter Set.....	SFA 61281SET
Air Filter Secondary.....	SFA 6130S
Air Filter Primary.....	SFA 61281P
Air Filter Set.....	SFA 6128SET
Air Filter Primary.....	SFA 6128P
Cabin Air Filter.....	SFC 50249
Cabin Air Filter.....	SFC 00684
Fuel Filter.....	SFF 6280
Fuel Filter.....	SFF 2001
Hydraulic Oil Filter.....	SFH 5577
Oil Filter Combination.....	SFO 8336
ZX135US (EXCAVATORS) ISUZU 4BG1T	
Cabin Air Filter.....	SFC 50249
Oil Filter Combination.....	SFO 8336
ZX135US (EXCAVATORS) ISUZU 4BG1 TCG (S/N: 060001-UP)	
Air Filter Secondary.....	SFA 8238S
Air Filter Primary.....	SFA 88891P
Air Filter Set.....	SFA 88891SET
Air Filter Primary.....	SFA 8889P
Air Filter Secondary.....	SFA 5485S
Air Filter Primary.....	SFA 77251P
Fuel Filter.....	SFF 6280
Hydraulic Oil Filter.....	SFH 7841
Hydraulic Oil Filter.....	SFH 5577
ZX135US (EXCAVATORS) ISUZU AJ-4JJ1XYS-A-03	
Hydraulic Oil Filter.....	SFH 5577
ZX135US (EXCAVATORS) S/N: 62997-UP	
Air Filter Primary.....	SFA 88891P
Air Filter Secondary.....	SFA 5485S
Air Filter Primary.....	SFA 77251P
Air Filter Primary.....	SFA 8889P
Air Filter Set.....	SFA 88891SET
Fuel Filter.....	SFF 2001
Fuel Filter.....	SFF 6280
Hydraulic Oil Filter.....	SFH 7841
ZX135US (EXCAVATORS) S/N: TO-62996	
Air Filter Secondary.....	SFA 8238S
Fuel Filter.....	SFF 2001
Fuel Filter.....	SFF 6280

MODEL/APPLICATION	SURE NO
-------------------	---------

HITACHI	
ZX135US (EXCAVATORS) S/N: TO-62996	
Hydraulic Oil Filter.....	SFH 7841
ZX16 (EXCAVATORS) ISUZU 3YB1	
Fuel Filter.....	SFF 3560
Hydraulic Oil Filter.....	SFH 4130
Hydraulic Oil Filter.....	SFH 0010
ZX18 (EXCAVATORS) ISUZU 3YB1	
Fuel Filter.....	SFF 3560
Hydraulic Oil Filter.....	SFH 0010
Hydraulic Oil Filter.....	SFH 4130
ZX180 (EXCAVATORS)	
Air Filter Set.....	SFA 88891SET
Air Filter Primary.....	SFA 8889P
Air Filter Secondary.....	SFA 5485S
Air Filter Primary.....	SFA 77251P
Air Filter Primary.....	SFA 88891P
Fuel Filter.....	SFF 6280
Fuel Filter.....	SFF 2001
Hydraulic Oil Filter.....	SFH 7841
ZX180LC (EXCAVATORS) ISUZU 4BG1T	
Cabin Air Filter.....	SFC 50249
ZX180LC (EXCAVATORS) ISUZU AA-4BG1TCS (S/N: 005001-UP)	
Air Filter Primary.....	SFA 88891P
Air Filter Primary.....	SFA 8889P
Air Filter Set.....	SFA 88891SET
Air Filter Secondary.....	SFA 5485S
Air Filter Primary.....	SFA 77251P
Fuel Filter.....	SFF 6280
Hydraulic Oil Filter.....	SFH 7841
ZX180LC-3 (EXCAVATORS) ISUZU AI-4JJ1X	
Cabin Air Filter.....	SFC 43580
ZX180LCN (EXCAVATORS) ISUZU 4BG1T	
Cabin Air Filter.....	SFC 50249
ZX180W (EXCAVATORS) ISUZU 4BG1X	
Cabin Air Filter.....	SFC 00684
Cabin Air Filter.....	SFC 50249
Hydraulic Oil Filter Return.....	SFH 3065
ZX180W (EXCAVATORS) ISUZU AA-4BG1 (S/N: 001001-UP)	
Air Filter Set.....	SFA 6128SET
Air Filter Set.....	SFA 61281SET
Air Filter Secondary.....	SFA 6130S
Air Filter Primary.....	SFA 6128P
Air Filter Primary.....	SFA 61281P
Fuel Filter.....	SFF 6280
Hydraulic Oil Filter Return.....	SFH 3773

MODEL/APPLICATION	SURE NO
-------------------	---------

HITACHI	
ZX180W (EXCAVATORS) ISUZU AA-4BG1 (S/N: 001001-UP)	
Hydraulic Oil Filter Suction.....	SFH 0224
ZX180W (EXCAVATORS)	
Air Filter Primary.....	SFA 6128P
Air Filter Secondary.....	SFA 6130S
Air Filter Primary.....	SFA 61281P
Air Filter Set.....	SFA 61281SET
Air Filter Set.....	SFA 6128SET
Fuel Filter.....	SFF 6280
Fuel Filter.....	SFF 2001
Hydraulic Oil Filter Return.....	SFH 3773
Hydraulic Oil Filter Suction.....	SFH 0224
ZX135USK (EXCAVATORS) ISUZU 4BG1T	
Cabin Air Filter.....	SFC 50249
Oil Filter Combination.....	SFO 8336
ZX135USK (EXCAVATORS) ISUZU 4BG1 TCG (S/N: 060001-UP)	
Air Filter Secondary.....	SFA 5485S
Air Filter Primary.....	SFA 77251P
Air Filter Primary.....	SFA 88891P
Air Filter Primary.....	SFA 8889P
Air Filter Secondary.....	SFA 8238S
Air Filter Set.....	SFA 88891SET
Fuel Filter.....	SFF 6280
Hydraulic Oil Filter.....	SFH 5577
Hydraulic Oil Filter.....	SFH 7841
ZX160 (EXCAVATORS) ISUZU AA-4BG1TC	
Cabin Air Filter.....	SFC 50249
ZX160 (EXCAVATORS)	
Air Filter Primary.....	SFA 8889P
Air Filter Set.....	SFA 88891SET
Air Filter Secondary.....	SFA 5485S
Air Filter Primary.....	SFA 77251P
Air Filter Primary.....	SFA 88891P
ZX160 (EXCAVATORS) W/ISUZU AA-4BG1TC ENG.	
Cabin Air Filter.....	SFC 00684
Oil Filter Combination.....	SFO 8336
ZX160LC (EXCAVATORS) ISUZU 4BG1	
Fuel Filter.....	SFF 0057
ZX160LC (EXCAVATORS) ISUZU AA-4BG1TC (S/N: 005001-UP)	
Air Filter Secondary.....	SFA 5485S
Air Filter Primary.....	SFA 77251P
Air Filter Primary.....	SFA 8889P
Air Filter Primary.....	SFA 88891P
Air Filter Set.....	SFA 88891SET
Fuel Filter.....	SFF 6280
Fuel Filter.....	SFF 2001



To order, please call:
+1 8448 BE SURE; +1 (925) 566-8863

For Reference Only - May not be a direct cross



Email :
order@suresfilter.us



Engine Application

MODEL/APPLICATION	SURE NO
HITACHI	
ZX160LC (EXCAVATORS) ISUZU AA-4BG1TC (S/N: 005001-UP) Hydraulic Oil Filter.....	SFH 7841
ZX160LC (EXCAVATORS) ISUZU AA-4BG1TC Cabin Air Filter.....	SFC 50249
ZX160LC (EXCAVATORS) Air Filter Primary..... Air Filter Set..... Air Filter Secondary..... Hydraulic Oil Filter.....	SFA 6098P SFA 6098SET SFA 8238S SFH 7841
ZX160LC (EXCAVATORS) W/ISUZU AA-4BG1TC ENG. Cabin Air Filter..... Oil Filter Combination.....	SFC 00684 SFO 8336
ZX160W (EXCAVATORS) ISUZU 4BG1T Cabin Air Filter.....	SFC 50249
ZX160W (EXCAVATORS) ISUZU 4BG1TC (S/N: 002002-UP) Air Filter Primary..... Air Filter Set..... Air Filter Set..... Air Filter Secondary..... Air Filter Primary.....	SFA 6128P SFA 6128SET SFA 61281SET SFA 6130S SFA 61281P
ZX160W (EXCAVATORS) ISUZU AA-4BG1TC Hydraulic Oil Filter.....	SFH 5577
ZX160W (EXCAVATORS) Air Filter Secondary..... Air Filter Primary..... Air Filter Primary..... Air Filter Set..... Air Filter Set..... Fuel Filter..... Fuel Filter.....	SFA 6130S SFA 6128P SFA 61281P SFA 61281SET SFA 6128SET SFF 2001 SFF 6280
ZX17U-2 (EXCAVATORS) YANMAR 3TNV70-VHB (S/N: 010001-UP) , 2007 Hydraulic Oil Filter.....	SFH 4130
ZX160LCT (EXCAVATORS) ISUZU CC-4BG1TC Cabin Air Filter.....	SFC 50249
ZX160LCT (EXCAVATORS) W/ISUZU CC-4BG1TC ENG. Cabin Air Filter.....	SFC 00684
ZX110M-3 (EXCAVATORS) ISUZU AJ-4JJ1X Cabin Air Filter..... Cabin Air Filter..... Oil Filter Combination.....	SFC 43580 SFC 50249 SFO 8336

MODEL/APPLICATION	SURE NO
HITACHI	
ZX130-3 (EXCAVATORS) ISUZU AJ-4JJ1X Cabin Air Filter..... Cabin Air Filter..... Oil Filter Combination.....	SFC 50249 SFC 43580 SFO 8336
ZX130K-3 (EXCAVATORS) ISUZU AJ-4JJ1X Cabin Air Filter..... Cabin Air Filter..... Oil Filter Combination.....	SFC 50249 SFC 43580 SFO 8336
ZX135US-3 (EXCAVATORS) ISUZU 4JJ1X Cabin Air Filter.....	SFC 50249
ZX140W-3 (EXCAVATORS) ISUZU AI-4JJ1X Cabin Air Filter..... Cabin Air Filter..... Hydraulic Oil Filter.....	SFC 43580 SFC 50249 SFH 8239
ZX140W-3 (EXCAVATORS) w/Isuzu AI-4JJ1X Eng. Oil Filter Combination.....	SFO 8336
ZX145W-3 (EXCAVATORS) ISUZU AI-4JJ1X Cabin Air Filter..... Cabin Air Filter.....	SFC 50249 SFC 43580
ZX145W-3 (EXCAVATORS) w/Isuzu AI-4JJ1X Eng. Oil Filter Combination.....	SFO 8336
ZX160LC-3 (EXCAVATORS) ISUZU AI-4JJ1X Cabin Air Filter.....	SFC 43580
ZX160LC-3 (EXCAVATORS) w/Isuzu AI-4JJ1X Eng. Oil Filter Combination.....	SFO 8336
ZX170W-3 (EXCAVATORS) ISUZU AI-4HK1X , 2017 Air Filter Secondary..... Air Filter Primary..... Air Filter Set.....	SFA 42117S SFA 42122P SFA 42122SET
ZX170W-3 (EXCAVATORS) ISUZU AI-4HK1X Cabin Air Filter..... Cabin Air Filter.....	SFC 50249 SFC 43580
ZX180LCN-3 (EXCAVATORS) ISUZU AI-4JJ1X Cabin Air Filter.....	SFC 43580
ZX190W-3 (EXCAVATORS) , 2007 Air Filter Primary..... Air Filter Set.....	SFA 42122P SFA 42122SET
ZX190W-3 (EXCAVATORS) ISUZU AI-4HK1X Cabin Air Filter.....	SFC 43580

MODEL/APPLICATION	SURE NO
HITACHI	
ZX190W-3 (EXCAVATORS) Air Filter Secondary.....	SFA 42117S
ZX125US (EXCAVATORS) ISUZU 4BG1T Cabin Air Filter..... Oil Filter Combination.....	SFC 50249 SFO 8336
ZX135US-E (EXCAVATORS) ISUZU 4BG1T Cabin Air Filter..... Oil Filter Combination.....	SFC 50249 SFO 8336
ZX135US-E (EXCAVATORS) ISUZU 4BG1 TCG (S/N: 060001-UP) Hydraulic Oil Filter.....	SFH 5577
ZX130-5 (EXCAVATORS) ISUZU 4JJ1 Fuel Filter.....	SFF R100
ZX180LC-5 (EXCAVATORS) ISUZU 4JJ1 Fuel Filter.....	SFF R100
ZX190W-5 (EXCAVATORS) ISUZU 4HK1 Fuel Filter.....	SFF R100
ZX200-3 (EXCAVATORS) ISUZU AH-4HK1XSA-02 , 2008 Air Filter Secondary..... Air Filter Primary..... Air Filter Set..... Air Filter Set..... Air Filter Primary..... Cabin Air Filter..... Cabin Air Filter.....	SFA 6130S SFA 61281P SFA 6128SET SFA 61281SET SFA 6128P SFC 32683 SFC 32689
ZX200-3 (EXCAVATORS) ISUZU 4HK1 Fuel Filter.....	SFF 0220
ZX200-3 (EXCAVATORS) ISUZU 4HK1X Cabin Air Filter.....	SFC 43580
ZX200LC-3 (EXCAVATORS) ISUZU AH-4HK1XSA-02 , 2008 Cabin Air Filter..... Cabin Air Filter.....	SFC 32689 SFC 32683
ZX200LC-3 (EXCAVATORS) ISUZU 4HK1 Hydraulic Oil Filter.....	SFH 8651
ZX200LC-3 (EXCAVATORS) ISUZU 4HK1X Cabin Air Filter.....	SFC 43580
ZX210H-3 (EXCAVATORS) ISUZU 4HK1-XSA-02 Air Filter Set..... Air Filter Primary..... Air Filter Secondary.....	SFA 61281SET SFA 61281P SFA 6130S



To order, please call:
+1 8448 BE SURE; +1 (925) 566-8863

For Reference Only - May not be a direct cross



Email :
order@suresfilter.us



Engine Application

MODEL/APPLICATION	SURE NO
HITACHI	
ZX210H-3 (EXCAVATORS) ISUZU 4HK1-XYSA-02	
Air Filter Primary.....	SFA 6128P
Air Filter Set.....	SFA 6128SET
Cabin Air Filter.....	SFC 32683
Cabin Air Filter.....	SFC 32689
ZX210H-3 (EXCAVATORS) ISUZU 4HK1X	
Cabin Air Filter.....	SFC 43580
ZX210K-3 (EXCAVATORS) ISUZU 4HK1-XYSA-02	
Cabin Air Filter.....	SFC 32683
Cabin Air Filter.....	SFC 32689
ZX210LCH-3 (EXCAVATORS) ISUZU 4HK1-XYSA-02	
Cabin Air Filter.....	SFC 32683
Cabin Air Filter.....	SFC 32689
ZX210LCH-3 (EXCAVATORS) ISUZU 4HK1	
Hydraulic Oil Filter.....	SFH 8651
ZX210LCH-3 (EXCAVATORS) ISUZU 4HK1X	
Cabin Air Filter.....	SFC 43580
ZX210LCK-3 (EXCAVATORS) ISUZU 4HK1-XYSA-02	
Air Filter Secondary.....	SFA 6130S
Air Filter Primary.....	SFA 6128P
Air Filter Set.....	SFA 61281SET
Air Filter Set.....	SFA 6128SET
Air Filter Primary.....	SFA 61281P
Cabin Air Filter.....	SFC 32683
Cabin Air Filter.....	SFC 32689
ZX210LCK-3 (EXCAVATORS) ISUZU 4HK1	
Hydraulic Oil Filter.....	SFH 8651
ZX210LCK-3 (EXCAVATORS) ISUZU 4HK1X	
Cabin Air Filter.....	SFC 43580
ZX240-3 (EXCAVATORS) ISUZU AH 4HK1 XYSA/20001 , 2006	
Cabin Air Filter.....	SFC 32689
Cabin Air Filter.....	SFC 32683
ZX240-3 (EXCAVATORS) ISUZU AH 4HK1 XYSA (S/N: 020001-UP) , 2006	
Air Filter Primary.....	SFA 6128P
Air Filter Set.....	SFA 61281SET
Air Filter Set.....	SFA 6128SET
Air Filter Primary.....	SFA 61281P
Air Filter Primary.....	SFA 61281P
Air Filter Set.....	SFA 61281SET
Air Filter Set.....	SFA 61281SET
Air Filter Secondary.....	SFA 6130S
ZX250H-3 (EXCAVATORS) ISUZU AH 4HK1 XYSA (S/N: 020001-UP) , 2006	
Air Filter Set.....	SFA 6128SET
Air Filter Primary.....	SFA 6128P
Air Filter Primary.....	SFA 61281P
Air Filter Primary.....	SFA 61281P
Air Filter Set.....	SFA 61281SET
Air Filter Set.....	SFA 61281SET
Air Filter Secondary.....	SFA 6130S
ZX250H-3 (EXCAVATORS) ISUZU AH 4HK1 XYSA (S/N: 020001-UP) , 2006	
Air Filter Primary.....	SFA 6128P
Air Filter Set.....	SFA 61281SET
Air Filter Set.....	SFA 6128SET
Air Filter Primary.....	SFA 61281P
Air Filter Primary.....	SFA 61281P
Air Filter Set.....	SFA 61281SET
Air Filter Set.....	SFA 61281SET
Air Filter Secondary.....	SFA 6130S
ZX250K-3 (EXCAVATORS) ISUZU AH 4HK1 XYSA/20001 , 2006	
Cabin Air Filter.....	SFC 32689
Cabin Air Filter.....	SFC 32683
ZX250K-3 (EXCAVATORS) ISUZU AH 4HK1 XYSA (S/N: 020001-UP) , 2006	
Cabin Air Filter.....	SFC 43580
Hydraulic Oil Filter.....	SFH 8651

MODEL/APPLICATION	SURE NO
HITACHI	
ZX240-3 (EXCAVATORS) ISUZU AI-4HK1X	
Cabin Air Filter.....	SFC 43580
ZX240LC-3 (EXCAVATORS) ISUZU AH 4HK1 XYSA/20001 , 2006	
Cabin Air Filter.....	SFC 32683
Cabin Air Filter.....	SFC 32689
ZX240LC-3 (EXCAVATORS) ISUZU AI-4HK1X	
Cabin Air Filter.....	SFC 43580
ZX240LC-3 (EXCAVATORS) ISUZU AH4HK	
Cabin Air Filter.....	SFC 43580
Hydraulic Oil Filter.....	SFH 8651
ZX240LC-3 (EXCAVATORS) ISUZU AH-4HK1X	
Hydraulic Oil Filter.....	SFH 8651
ZX250-3 (EXCAVATORS) ISUZU AH-4HK1XYSA-01 , 2006	
Air Filter Primary.....	SFA 61281P
Air Filter Set.....	SFA 61281SET
Air Filter Secondary.....	SFA 6130S
Air Filter Primary.....	SFA 6128P
Air Filter Set.....	SFA 6128SET
Cabin Air Filter.....	SFC 32689
Cabin Air Filter.....	SFC 32683
ZX250-3 (EXCAVATORS)	
Air Filter Primary.....	SFA 6128P
Air Filter Secondary.....	SFA 6130S
Air Filter Primary.....	SFA 61281P
Air Filter Set.....	SFA 61281SET
Air Filter Set.....	SFA 61281SET
ZX250H-3 (EXCAVATORS) ISUZU AH 4HK1 XYSA/20001 , 2006	
Cabin Air Filter.....	SFC 32683
Cabin Air Filter.....	SFC 32689
ZX250H-3 (EXCAVATORS) ISUZU AH 4HK1 XYSA (S/N: 020001-UP) , 2006	
Air Filter Set.....	SFA 6128SET
Air Filter Primary.....	SFA 6128P
Air Filter Primary.....	SFA 61281P
Air Filter Set.....	SFA 61281SET
Air Filter Set.....	SFA 61281SET
Air Filter Secondary.....	SFA 6130S
ZX250H-3 (EXCAVATORS) ISUZU AH-4HK1X	
Cabin Air Filter.....	SFC 43580
ZX250K-3 (EXCAVATORS) ISUZU AH 4HK1 XYSA/20001 , 2006	
Cabin Air Filter.....	SFC 32689
Cabin Air Filter.....	SFC 32683
ZX250K-3 (EXCAVATORS) ISUZU AH 4HK1 XYSA (S/N: 020001-UP) , 2006	
Air Filter Primary.....	SFA 6128P

MODEL/APPLICATION	SURE NO
HITACHI	
ZX250K-3 (EXCAVATORS) ISUZU AH 4HK1 XYSA (S/N: 020001-UP) , 2006	
Air Filter Secondary.....	SFA 6130S
Air Filter Set.....	SFA 61281SET
Air Filter Set.....	SFA 6128SET
Air Filter Primary.....	SFA 61281P
ZX250K-3 (EXCAVATORS) ISUZU AH-4HK1X	
Cabin Air Filter.....	SFC 43580
ZX250LC-3 (EXCAVATORS) ISUZU AH 4HK1 XYSA/20001 , 2006	
Cabin Air Filter.....	SFC 32683
Cabin Air Filter.....	SFC 32689
ZX250LC-3 (EXCAVATORS) ISUZU AH 4HK1 XYSA (S/N: 020001-UP) , 2006	
Air Filter Secondary.....	SFA 6130S
Air Filter Primary.....	SFA 61281P
Air Filter Set.....	SFA 6128SET
Air Filter Primary.....	SFA 6128P
Air Filter Set.....	SFA 61281SET
ZX250LC-3 (EXCAVATORS) ISUZU AH-4HK1X	
Cabin Air Filter.....	SFC 43580
ZX250LCH-3 (EXCAVATORS) ISUZU AH 4HK1 XYSA/20001 , 2006	
Cabin Air Filter.....	SFC 32683
Cabin Air Filter.....	SFC 32689
ZX250LCH-3 (EXCAVATORS) ISUZU AH4HK	
Hydraulic Oil Filter.....	SFH 8651
ZX250LCH-3 (EXCAVATORS) ISUZU AH-4HK1X	
Cabin Air Filter.....	SFC 43580
ZX250LCH-3 (EXCAVATORS) ISUZU AH-4HK1XYSA	
Hydraulic Oil Filter.....	SFH 8651
ZX250LCK-3 (EXCAVATORS) ISUZU AH 4HK1 XYSA/20001 , 2006	
Cabin Air Filter.....	SFC 32689
Cabin Air Filter.....	SFC 32683
ZX250LCK-3 (EXCAVATORS) ISUZU AH4HK	
Hydraulic Oil Filter.....	SFH 8651
ZX250LCK-3 (EXCAVATORS) ISUZU AH-4HK1X	
Cabin Air Filter.....	SFC 43580
ZX250LCN-3 (EXCAVATORS) ISUZU AH 4HK1 XYSA/20001 , 2006	
Cabin Air Filter.....	SFC 32689
Cabin Air Filter.....	SFC 32683
ZX250LCN-3 (EXCAVATORS) ISUZU AH4HK	
Hydraulic Oil Filter.....	SFH 8651



Engine Application

MODEL/APPLICATION	SURE NO
HITACHI	
ZX250LCN-3 (EXCAVATORS) ISUZU AH-4HK1X Cabin Air Filter.....	SFC 43580
ZX270-3 (EXCAVATORS) ISUZU ISUZU/30001 , 2006 Cabin Air Filter..... Cabin Air Filter.....	SFC 32689 SFC 32683
ZX270-3 (EXCAVATORS) ISUZU (S/N: 030001-UP) , 2006 Air Filter Primary..... Air Filter Secondary..... Air Filter Primary..... Air Filter Set..... Air Filter Set.....	SFA 6128P SFA 6130S SFA 61281P SFA 61281SET SFA 6128SET
ZX270-3 (EXCAVATORS) ISUZU AH-4HK1X Cabin Air Filter.....	SFC 43580
ZX270LC-3 (EXCAVATORS) ISUZU ISUZU/30001 , 2006 Cabin Air Filter..... Cabin Air Filter.....	SFC 32689 SFC 32683
ZX270LC-3 (EXCAVATORS) ISUZU AH-4HK1X Cabin Air Filter.....	SFC 43580
ZX280LC-3 (EXCAVATORS) ISUZU ISUZU/30001 , 2006 Cabin Air Filter..... Cabin Air Filter.....	SFC 32683 SFC 32689
ZX280LC-3 (EXCAVATORS) ISUZU (S/N: 030001-UP) , 2006 Air Filter Set..... Air Filter Primary..... Air Filter Set..... Air Filter Secondary..... Air Filter Primary.....	SFA 61281SET SFA 61281P SFA 6128SET SFA 6130S SFA 6128P
ZX280LCH-3 (EXCAVATORS) ISUZU ISUZU/30001 , 2006 Cabin Air Filter..... Cabin Air Filter.....	SFC 32689 SFC 32683
ZX280LCH-3 (EXCAVATORS) ISUZU AH-4HK1X Cabin Air Filter.....	SFC 43580
ZX280LCN-3 (EXCAVATORS) ISUZU ISUZU/30001 , 2006 Cabin Air Filter..... Cabin Air Filter.....	SFC 32689 SFC 32683
ZX280LCN-3 (EXCAVATORS) ISUZU AH-4HK1X Cabin Air Filter.....	SFC 43580
ZX200LC (EXCAVATORS) ISUZU 6BG1TRA , 2002 Air Filter Set..... Air Filter Primary..... Fuel Filter..... Fuel Filter..... Hydraulic Oil Filter..... Hydraulic Oil Filter Return..... Hydraulic Oil Filter Suction.....	SFA 6130S SFA 6128SET SFA 61281P SFF 6280 SFF 0052 SFH 7841 SFH 3773 SFH 0224
ZX200LC (EXCAVATORS) ISUZU 6BG1 Cabin Air Filter..... Fuel Filter.....	SFC 50249 SFF 2564
ZX200LC-E (EXCAVATORS) ISUZU 6BG1 Cabin Air Filter..... Fuel Filter.....	SFC 50249 SFF 2564
ZX210 (EXCAVATORS) ISUZU 6BG1T Cabin Air Filter..... Fuel Filter.....	SFC 50249 SFF 2564
ZX210 (EXCAVATORS) ISUZU AI-4HK1X Fuel/Water Separator.....	SFR 7134FW
ZX210 (EXCAVATORS) Air Filter Secondary..... Air Filter Primary..... Air Filter Set..... Air Filter Primary..... Air Filter Set..... Fuel Filter..... Fuel Filter..... Hydraulic Oil Filter..... Hydraulic Oil Filter Suction..... Hydraulic Oil Filter Return.....	SFA 6130S SFA 61281P SFA 6128SET SFA 6128P SFA 61281SET SFF 6280 SFF 0052 SFH 7841 SFH 0224 SFH 3773
ZX210-3 (EXCAVATORS) Air Filter Primary..... Air Filter Set..... Air Filter Secondary..... Air Filter Set..... Air Filter Primary.....	SFA 61281P SFA 61281SET SFA 6130S SFA 6128SET SFA 6128P
ZX210LCH (EXCAVATORS) ISUZU 6BG1T Cabin Air Filter.....	SFC 50249
ZX210LCH (EXCAVATORS) ISUZU 6BG1 Fuel Filter.....	SFF 2564
ZX210LCK (EXCAVATORS) ISUZU 6BG1T Cabin Air Filter.....	SFC 50249
ZX210LCK (EXCAVATORS) ISUZU 6BG1 Fuel Filter.....	SFF 2564
ZX210LCK (EXCAVATORS) ISUZU 6BG1 Fuel Filter.....	SFF 2564

MODEL/APPLICATION	SURE NO
HITACHI	
ZX210LCK (EXCAVATORS) ISUZU 6BG1 Fuel Filter.....	SFF 2564
ZX210W (EXCAVATORS) ISUZU 6BG1T Cabin Air Filter..... Fuel Filter.....	SFC 50249 SFF 2564
ZX210W (EXCAVATORS) ISUZU AA-6BG1T Air Filter Secondary..... Air Filter Primary..... Air Filter Set..... Air Filter Primary..... Air Filter Set..... Fuel Filter..... Fuel Filter..... Hydraulic Oil Filter Return..... Hydraulic Oil Filter Suction.....	SFA 6130S SFA 61281P SFA 6128SET SFA 6128P SFA 61281SET SFF 0052 SFF 6280 SFH 3773 SFH 0224
ZX210W-3 (EXCAVATORS) ISUZU 4HK1 Air Filter Secondary..... Air Filter Set..... Air Filter Primary.....	SFA 42117S SFA 42122SET SFA 42122P
ZX210W-3 (EXCAVATORS) ISUZU AI-4HK1X Cabin Air Filter.....	SFC 43580
ZX230 (EXCAVATORS) ISUZU 6BG1T Cabin Air Filter..... Fuel Filter.....	SFC 50249 SFF 2564
ZX230 (EXCAVATORS) ISUZU CC6BG1TRA01 Air Filter Set..... Air Filter Primary..... Air Filter Set..... Air Filter Secondary..... Air Filter Primary..... Fuel Filter..... Fuel Filter..... Hydraulic Oil Filter..... Hydraulic Oil Filter Suction..... Hydraulic Oil Filter Return.....	SFA 6128SET SFA 61281P SFA 61281SET SFA 6130S SFA 6128P SFF 6280 SFF 0052 SFH 7841 SFH 0224 SFH 3773
ZX230LC (EXCAVATORS) ISUZU 6BG1 Fuel Filter.....	SFF 2564
ZX240 (EXCAVATORS) ISUZU 6BG1 Air Filter Set..... Air Filter Set..... Air Filter Primary..... Air Filter Primary..... Air Filter Secondary..... Fuel Filter..... Fuel Filter..... Fuel Filter.....	SFA 61281SET SFA 6128SET SFA 6128P SFA 61281P SFA 6130S SFF 0052 SFF 2564 SFF 6280

MODEL/APPLICATION	SURE NO
HITACHI	
ZX210LCK (EXCAVATORS) ISUZU 6BG1 Fuel Filter.....	SFF 2564
ZX210W (EXCAVATORS) ISUZU 6BG1T Cabin Air Filter..... Fuel Filter.....	SFC 50249 SFF 2564
ZX210W (EXCAVATORS) ISUZU AA-6BG1T Air Filter Secondary..... Air Filter Primary..... Air Filter Set..... Air Filter Primary..... Air Filter Set..... Fuel Filter..... Fuel Filter..... Hydraulic Oil Filter Return..... Hydraulic Oil Filter Suction.....	SFA 6130S SFA 61281P SFA 6128SET SFA 6128P SFA 61281SET SFF 0052 SFF 6280 SFH 3773 SFH 0224
ZX210W-3 (EXCAVATORS) ISUZU 4HK1 Air Filter Secondary..... Air Filter Set..... Air Filter Primary.....	SFA 42117S SFA 42122SET SFA 42122P
ZX210W-3 (EXCAVATORS) ISUZU AI-4HK1X Cabin Air Filter.....	SFC 43580
ZX230 (EXCAVATORS) ISUZU 6BG1T Cabin Air Filter..... Fuel Filter.....	SFC 50249 SFF 2564
ZX230 (EXCAVATORS) ISUZU CC6BG1TRA01 Air Filter Set..... Air Filter Primary..... Air Filter Set..... Air Filter Secondary..... Air Filter Primary..... Fuel Filter..... Fuel Filter..... Hydraulic Oil Filter..... Hydraulic Oil Filter Suction..... Hydraulic Oil Filter Return.....	SFA 6128SET SFA 61281P SFA 61281SET SFA 6130S SFA 6128P SFF 6280 SFF 0052 SFH 7841 SFH 0224 SFH 3773
ZX230LC (EXCAVATORS) ISUZU 6BG1 Fuel Filter.....	SFF 2564
ZX240 (EXCAVATORS) ISUZU 6BG1 Air Filter Set..... Air Filter Set..... Air Filter Primary..... Air Filter Primary..... Air Filter Secondary..... Fuel Filter..... Fuel Filter..... Fuel Filter.....	SFA 61281SET SFA 6128SET SFA 6128P SFA 61281P SFA 6130S SFF 0052 SFF 2564 SFF 6280



To order, please call:
+1 8448 BE SURE; +1 (925) 566-8863

For Reference Only - May not be a direct cross



Email :
order@suresfilter.us



Engine Application

MODEL/APPLICATION	SURE NO
HITACHI	
ZX240 (EXCAVATORS) ISUZU 6BG1	
Hydraulic Oil Filter Return.....	SFH 3773
Hydraulic Oil Filter.....	SFH 7841
Hydraulic Oil Filter Suction.....	SFH 0224
ZX240H (EXCAVATORS) ISUZU 6BG1T	
Fuel Filter.....	SFF 2564
ZX240K (EXCAVATORS) ISUZU 6BG1T	
Cabin Air Filter.....	SFC 50249
ZX240K (EXCAVATORS) ISUZU CC-6BG1T	
Fuel Filter.....	SFF 3486
ZX240LCH (EXCAVATORS) ISUZU 6BG1	
Fuel Filter.....	SFF 2564
ZX240LCK (EXCAVATORS) ISUZU 6BG1	
Fuel Filter.....	SFF 2564
ZX25 (EXCAVATORS) ISUZU 3YE1	
Fuel Filter.....	SFF 3560
Hydraulic Oil Filter.....	SFH 0010
Hydraulic Oil Filter.....	SFH 4130
ZX250 (EXCAVATORS) ISUZU , 2005	
Air Filter Primary.....	SFA 61281P
Air Filter Set.....	SFA 61281SET
Air Filter Secondary.....	SFA 6130S
Air Filter Set.....	SFA 6128SET
Air Filter Primary.....	SFA 6128P
Fuel Filter.....	SFF 6280
Fuel Filter.....	SFF 0052
Hydraulic Oil Filter Return.....	SFH 3773
Hydraulic Oil Filter Suction.....	SFH 0224
Hydraulic Oil Filter.....	SFH 7841
ZX250LC (EXCAVATORS) ISUZU CC-6BG1T	
Cabin Air Filter.....	SFC 50249
ZX250LCN (EXCAVATORS) ISUZU CC 6BG1 (S/N: 010001-UP) , 2006	
Air Filter Secondary.....	SFA 6130S
Air Filter Primary.....	SFA 6128P
Air Filter Set.....	SFA 6128SET
Air Filter Primary.....	SFA 61281P
Air Filter Set.....	SFA 61281SET
Fuel Filter.....	SFF 0052
Fuel Filter.....	SFF 6280
Hydraulic Oil Filter.....	SFH 7841
Hydraulic Oil Filter Suction.....	SFH 0224
ZX250LCN (EXCAVATORS) ISUZU 6BG1	
Fuel Filter.....	SFF 2564

MODEL/APPLICATION	SURE NO
HITACHI	
ZX250LCN (EXCAVATORS) ISUZU CC-6BG1T	
Cabin Air Filter.....	SFC 50249
ZX270 (EXCAVATORS) ISUZU 6BG1T	
Fuel Filter.....	SFF 2564
ZX270 (EXCAVATORS) ISUZU 6BG1	
Cabin Air Filter.....	SFC 50249
ZX270 (EXCAVATORS) ISUZU 6BG1TRA02	
Air Filter Set.....	SFA 6128SET
Air Filter Set.....	SFA 61281SET
Air Filter Primary.....	SFA 6128P
Air Filter Primary.....	SFA 61281P
Air Filter Secondary.....	SFA 6130S
Fuel Filter.....	SFF 0052
Fuel Filter.....	SFF 6280
Hydraulic Oil Filter Return.....	SFH 3773
Hydraulic Oil Filter.....	SFH 7841
Hydraulic Oil Filter Suction.....	SFH 0224
Hydraulic Oil Filter.....	SFH 7634
ZX270LC (EXCAVATORS) ISUZU 6BG1	
Cabin Air Filter.....	SFC 50249
Fuel Filter.....	SFF 2564
ZX27U-2 (EXCAVATORS) YANMAR 3TNV88 (S/N: 010001-UP) , 2006	
Air Filter Secondary.....	SFA 2858S
Air Filter Primary.....	SFA 1575P
Hydraulic Oil Filter.....	SFH 4130
ZX280-3 (EXCAVATORS) , 2007	
Air Filter Primary.....	SFA 6128P
Air Filter Set.....	SFA 61281SET
Air Filter Secondary.....	SFA 6130S
Air Filter Primary.....	SFA 61281P
Air Filter Set.....	SFA 6128SET
ZX280LC (EXCAVATORS) ISUZU 6BG1TRA02 (S/N: 020001-UP) , 2006	
Air Filter Secondary.....	SFA 6130S
Air Filter Set.....	SFA 6128SET
Air Filter Primary.....	SFA 61281P
Air Filter Set.....	SFA 61281SET
Air Filter Primary.....	SFA 6128P
Fuel Filter.....	SFF 0052
Fuel Filter.....	SFF 6280
Hydraulic Oil Filter Suction.....	SFH 0224
Hydraulic Oil Filter.....	SFH 7841
Hydraulic Oil Filter Return.....	SFH 3773
ZX280LC (EXCAVATORS) ISUZU 6BG1T	
Cabin Air Filter.....	SFC 50249
Fuel Filter.....	SFF 2564

MODEL/APPLICATION	SURE NO
HITACHI	
ZX280LCN (EXCAVATORS) ISUZU 6BG1T	
Cabin Air Filter.....	SFC 50249
ZX280LCN (EXCAVATORS) ISUZU 6BG1	
Fuel Filter.....	SFF 2564
ZX210LC III (EXCAVATORS) , 2007	
Air Filter Primary.....	SFA 6128P
Air Filter Primary.....	SFA 61281P
Air Filter Set.....	SFA 61281SET
Air Filter Secondary.....	SFA 6130S
Air Filter Set.....	SFA 6128SET
ZX225US (EXCAVATORS) ISUZU 6BG1	
Cabin Air Filter.....	SFC 50249
ZX225US (EXCAVATORS) ISUZU 6BG1TRA03	
Air Filter Primary.....	SFA 6128P
Air Filter Secondary.....	SFA 6130S
Air Filter Set.....	SFA 6128SET
Air Filter Primary.....	SFA 61281P
Air Filter Set.....	SFA 61281SET
Fuel Filter.....	SFF 0052
Fuel Filter.....	SFF 6280
Hydraulic Oil Filter.....	SFH 7841
Hydraulic Oil Filter Return.....	SFH 3773
Hydraulic Oil Filter Suction.....	SFH 0224
ZX225US-3 (EXCAVATORS) ISUZU 4HK1-XYSA-02 , 2008	
Air Filter Set.....	SFA 61281SET
Air Filter Primary.....	SFA 61281P
Air Filter Set.....	SFA 6128SET
Air Filter Secondary.....	SFA 6130S
Air Filter Primary.....	SFA 6128P
ZX225US-E (EXCAVATORS) ISUZU 6BG1TRA03	
Air Filter Primary.....	SFA 6128P
Air Filter Primary.....	SFA 61281P
Air Filter Set.....	SFA 6128SET
Air Filter Set.....	SFA 61281SET
Air Filter Secondary.....	SFA 6130S
Fuel Filter.....	SFF 0052
Fuel Filter.....	SFF 6280
Hydraulic Oil Filter Suction.....	SFH 0224
Hydraulic Oil Filter.....	SFH 7841
ZX225USR (EXCAVATORS) ISUZU 6BG1T , 2002	
Air Filter Set.....	SFA 6128SET
Air Filter Primary.....	SFA 6128P
Air Filter Primary.....	SFA 61281P
Air Filter Set.....	SFA 61281SET
Air Filter Secondary.....	SFA 6130S
Fuel Filter.....	SFF 0052
Hydraulic Oil Filter.....	SFH 7841



To order, please call:
+1 8448 BE SURE; +1 (925) 566-8863

For Reference Only - May not be a direct cross



Email :
order@suresfilter.us



Engine Application

MODEL/APPLICATION	SURE NO
-------------------	---------

HITACHI	
ZX225USR (EXCAVATORS) ISUZU 6BG1T , 2002 Hydraulic Oil Filter Suction.....	SFH 0224
Hydraulic Oil Filter Return.....	SFH 3773
ZX225USR (EXCAVATORS) ISUZU 6BG1T Fuel Filter.....	SFF 2564
ZX225USR (EXCAVATORS) ISUZU 6BG1 Cabin Air Filter.....	SFC 50249
ZX225USR-3 (EXCAVATORS) ISUZU 4HK1-XYSA-02 , 2008 Air Filter Set.....	SFA 6128SET
Air Filter Set.....	SFA 61281SET
Air Filter Secondary.....	SFA 6130S
Air Filter Primary.....	SFA 61281P
Air Filter Primary.....	SFA 6128P
ZX225USRK-3 (EXCAVATORS) ISUZU 4HK1-XYSA-02 Air Filter Secondary.....	SFA 6130S
Air Filter Set.....	SFA 6128SET
Air Filter Primary.....	SFA 6128P
Air Filter Primary.....	SFA 61281P
Air Filter Set.....	SFA 61281SET
ZX225USRK-3 (EXCAVATORS) ISUZU 4HK1X Cabin Air Filter.....	SFC 50249
ZX200-5G (EXCAVATORS) ISUZU CC-6BG1T Cabin Air Filter.....	SFC 01490
ZX210LCH-5G (EXCAVATORS) ISUZU AH-4HK1XYSA-01 Cabin Air Filter.....	SFC 01490
ZX200 (EXCAVATORS) ISUZU 6BG1T Fuel Filter.....	SFF 2564
ZX200 (EXCAVATORS) ISUZU 6BG1 Cabin Air Filter.....	SFC 50249
ZX210H (EXCAVATORS) ISUZU 6BG1T Cabin Air Filter.....	SFC 50249
ZX210K (EXCAVATORS) ISUZU 6BG1T Cabin Air Filter.....	SFC 50249
ZX210LC (EXCAVATORS) ISUZU 6BG1T Cabin Air Filter.....	SFC 50249
ZX225USLC (EXCAVATORS) ISUZU 6BG1T Fuel Filter.....	SFF 2564

MODEL/APPLICATION	SURE NO
-------------------	---------

HITACHI	
ZX225USLC (EXCAVATORS) ISUZU 6BG1 Fuel Filter.....	SFF 2564
ZX225USLC-3 (EXCAVATORS) ISUZU 4HK1 Hydraulic Oil Filter.....	SFH 8651
ZX225USRK (EXCAVATORS) ISUZU 6BG1 Cabin Air Filter.....	SFC 50249
ZX225USRK (EXCAVATORS) ISUZU 6BG1 Fuel Filter.....	SFF 2564
ZX225USRLC (EXCAVATORS) ISUZU 6BG1T Hydraulic Oil Filter.....	SFH 8651
ZX225USRLC-E (EXCAVATORS) ISUZU 6BG1T Fuel Filter.....	SFF 2564
ZX225USRLC (EXCAVATORS) ISUZU 6BG1T Fuel Filter.....	SFF 2564
ZX225USRKLC-3 (EXCAVATORS) ISUZU 4HK1 Hydraulic Oil Filter.....	SFH 8651
ZX210-5 (EXCAVATORS) ISUZU CC-6BG1 Fuel Filter.....	SFF R100
ZX250LC-5 (EXCAVATORS) ISUZU 4HK1ZXSA-01 Fuel Filter.....	SFF 9016
Fuel Filter.....	SFF R100
ZX290LC-5 (EXCAVATORS) ISUZU AH-4KIX Fuel Filter.....	SFF R100
ZX225USLC-E (EXCAVATORS) ISUZU 6BG1T Fuel Filter.....	SFF 2564
ZX225USLC-E (EXCAVATORS) ISUZU 6BG1 Fuel Filter.....	SFF 2564
ZX330-3 (EXCAVATORS) , 2008 Air Filter Primary.....	SFA 2363P
Air Filter Set.....	SFA 2363SET
Air Filter Secondary.....	SFA 8813S
Hydraulic Oil Filter.....	SFH 6608
Hydraulic Oil Filter.....	SFH 0525
Oil Filter Combination.....	SFO 1256
ZX330-3 (EXCAVATORS) ISUZU AH 6HK1 XYSA/50001 , 2006 Air Filter Set.....	SFA 0022SET
Air Filter Primary.....	SFA 0022PF
Air Filter Primary.....	SFA 0022PF

MODEL/APPLICATION	SURE NO
-------------------	---------

HITACHI	
ZX330-3 (EXCAVATORS) ISUZU AH 6HK1 XYSA/50001 , 2006 Cabin Air Filter.....	SFC 32689
Cabin Air Filter.....	SFC 32683
ZX330-3 (EXCAVATORS) ISUZU AH 6HK1 XYSA (S/N: 050001-UP) , 2006 Air Filter Primary.....	SFA 0022PF
Air Filter Set.....	SFA 0022SET
Air Filter Secondary.....	SFA 8813S
ZX330-3 (EXCAVATORS) ISUZU AH-6HK1X Cabin Air Filter.....	SFC 43580
ZX350H-3 (EXCAVATORS) , 2008 Air Filter Primary.....	SFA 2363P
Air Filter Set.....	SFA 2363SET
Air Filter Secondary.....	SFA 8813S
Hydraulic Oil Filter.....	SFH 6608
Hydraulic Oil Filter.....	SFH 0525
Oil Filter Combination.....	SFO 1256
ZX350H-3 (EXCAVATORS) ISUZU AH 6HK1 XYSA/50001 , 2006 Air Filter Set.....	SFA 0022SET
Air Filter Primary.....	SFA 0022PF
Cabin Air Filter.....	SFC 32683
Cabin Air Filter.....	SFC 32689
ZX350H-3 (EXCAVATORS) ISUZU AH 6HK1 XYSA (S/N: 050001-UP) , 2006 Air Filter Primary.....	SFA 0022PF
Air Filter Set.....	SFA 0022SET
Air Filter Secondary.....	SFA 8813S
ZX350H-3 (EXCAVATORS) ISUZU AH-6HK1X Cabin Air Filter.....	SFC 43580
ZX350LC (EXCAVATORS) W/ISUZU AA-6HK1 ENG. Cabin Air Filter.....	SFC 00684
ZX330LC-3 (EXCAVATORS) ISUZU AH 6HK1 XYSA/50001 , 2006 Air Filter Primary.....	SFA 0022PF
Air Filter Set.....	SFA 0022SET
Cabin Air Filter.....	SFC 32689
Cabin Air Filter.....	SFC 32683
ZX330LC-3 (EXCAVATORS) ISUZU AH-6HK1X Cabin Air Filter.....	SFC 43580
ZX330LC-3 (EXCAVATORS) ISUZU 6HK1 Hydraulic Oil Filter.....	SFH 8651
ZX330LC-3 (EXCAVATORS) ISUZU 6WG1 Cabin Air Filter.....	SFC 43580
Hydraulic Oil Filter.....	SFH 8651



To order, please call:
+1 8448 BE SURE; +1 (925) 566-8863

For Reference Only - May not be a direct cross



Email :
order@suresfilter.us



Engine Application

MODEL/APPLICATION	SURE NO
HITACHI	
ZX350-3 (EXCAVATORS) ISUZU AH-6HK1XYSA-01 , 2008	Air Filter Set..... SFA 0022SET Air Filter Primary..... SFA 0022PF Air Filter Secondary..... SFA 8813S Cabin Air Filter..... SFC 32683 Cabin Air Filter..... SFC 32689
ZX350K-3 (EXCAVATORS) ISUZU AH 6HK1 XYSA/50001 , 2006	Air Filter Primary..... SFA 0022PF Air Filter Set..... SFA 0022SET Cabin Air Filter..... SFC 32689 Cabin Air Filter..... SFC 32683
ZX350K-3 (EXCAVATORS) ISUZU AH 6HK1 XYSA (S/N: 050001-UP) , 2006	Air Filter Primary..... SFA 0022PF Air Filter Set..... SFA 0022SET Air Filter Secondary..... SFA 8813S
ZX350K-3 (EXCAVATORS) ISUZU AH-6HK1X	Cabin Air Filter..... SFC 43580
ZX350LCH-3 (EXCAVATORS) ISUZU AH 6HK1 XYSA/50001 , 2006	Air Filter Primary..... SFA 0022PF Air Filter Set..... SFA 0022SET Cabin Air Filter..... SFC 32689 Cabin Air Filter..... SFC 32683
ZX350LCH-3 (EXCAVATORS) ISUZU AH-6HK1X	Cabin Air Filter..... SFC 43580
ZX350LCH-3 (EXCAVATORS) ISUZU 6HK1	Hydraulic Oil Filter..... SFH 8651
ZX350LCK-3 (EXCAVATORS) ISUZU AH 6HK1 XYSA/50001 , 2006	Air Filter Primary..... SFA 0022PF Air Filter Set..... SFA 0022SET Cabin Air Filter..... SFC 32689 Cabin Air Filter..... SFC 32683
ZX350LCK-3 (EXCAVATORS) ISUZU AH-6HK1X	Cabin Air Filter..... SFC 43580
ZX350LCK-3 (EXCAVATORS) ISUZU 6HK1	Hydraulic Oil Filter..... SFH 8651
ZX350LCN-3 (EXCAVATORS) ISUZU AH 6HK1 XYSA/50001 , 2006	Air Filter Set..... SFA 0022SET Air Filter Primary..... SFA 0022PF Cabin Air Filter..... SFC 32689 Cabin Air Filter..... SFC 32683
ZX350LCN-3 (EXCAVATORS) ISUZU AH-6HK1X	Cabin Air Filter..... SFC 43580

MODEL/APPLICATION	SURE NO
HITACHI	
ZX350LCN-3 (EXCAVATORS) ISUZU AH-6HK1X	ZX350LCN-3 (EXCAVATORS) ISUZU 6HK1 Hydraulic Oil Filter..... SFH 8651
ZX350LCN-3 (EXCAVATORS) ISUZU 6WG1	Cabin Air Filter..... SFC 43580 Hydraulic Oil Filter..... SFH 8651
ZX350N-3 (EXCAVATORS) ISUZU AH 6HK1 XYSA/50001 , 2006	Air Filter Primary..... SFA 0022PF Air Filter Set..... SFA 0022SET Cabin Air Filter..... SFC 32683 Cabin Air Filter..... SFC 32689
ZX350N-3 (EXCAVATORS) ISUZU AH 6HK1 XYSA (S/N: 050001-UP) , 2006	Air Filter Secondary..... SFA 8813S Air Filter Primary..... SFA 0022PF Air Filter Set..... SFA 0022SET
ZX330 (EXCAVATORS) ISUZU AA-6HK1XQA , 2002	Air Filter Secondary..... SFA 8813S Air Filter Set..... SFA 0022SET Air Filter Primary..... SFA 0022PF Fuel Filter..... SFF 2631 Fuel Filter..... SFF 6280 Hydraulic Oil Filter Suction..... SFH 0224 Hydraulic Oil Filter..... SFH 7841 Hydraulic Oil Filter Return..... SFH 3773
ZX330 (EXCAVATORS) ISUZU 6HK1	Cabin Air Filter..... SFC 50249
ZX330LC (EXCAVATORS) ISUZU AA-6HK1XQA , 2002	Air Filter Set..... SFA 0022SET Air Filter Primary..... SFA 0022PF
ZX330LC (EXCAVATORS) ISUZU 6HK1	Cabin Air Filter..... SFC 50249
ZX350 (EXCAVATORS) ISUZU ISUZU , 2005	Air Filter Set..... SFA 0022SET Air Filter Primary..... SFA 0022PF
ZX350 (EXCAVATORS) ISUZU , 2005	Air Filter Secondary..... SFA 8813S Air Filter Set..... SFA 0022SET Air Filter Primary..... SFA 0022PF Fuel Filter..... SFF 6280 Fuel Filter..... SFF 2631 Hydraulic Oil Filter Suction..... SFH 0224 Hydraulic Oil Filter Return..... SFH 3773 Hydraulic Oil Filter..... SFH 7841

MODEL/APPLICATION	SURE NO
HITACHI	
ZX350H (EXCAVATORS) ISUZU AA-6HK1XQA , 2002	Air Filter Primary..... SFA 0022PF Air Filter Set..... SFA 0022SET
ZX350H (EXCAVATORS) ISUZU AA-6HK1	Cabin Air Filter..... SFC 50249
ZX350H (EXCAVATORS) W/ISUZU AA-6HK1 ENG.	Cabin Air Filter..... SFC 00684
ZX350K (EXCAVATORS) ISUZU AA-6HK1XQA , 2002	Air Filter Primary..... SFA 0022PF Air Filter Set..... SFA 0022SET
ZX350K (EXCAVATORS) ISUZU AA-6HK1	Cabin Air Filter..... SFC 50249
ZX350K (EXCAVATORS) W/ISUZU AA-6HK1 ENG.	Cabin Air Filter..... SFC 00684
ZX350LC-3 (EXCAVATORS) ISUZU ISUZU TIER 3 , 2007	Air Filter Set..... SFA 0022SET Air Filter Primary..... SFA 0022PF
ZX350LC-3 (EXCAVATORS) ISUZU AH-6HK1X	Cabin Air Filter..... SFC 43580
ZX350LCH (EXCAVATORS) ISUZU AA-6HK1XQA , 2002	Air Filter Primary..... SFA 0022PF Air Filter Set..... SFA 0022SET
ZX350LCH (EXCAVATORS) ISUZU AA-6HK1	Cabin Air Filter..... SFC 50249
ZX350LCH (EXCAVATORS) W/ISUZU AA-6HK1 ENG.	Cabin Air Filter..... SFC 00684
ZX350LCK (EXCAVATORS) ISUZU AA-6HK1XQA , 2002	Air Filter Primary..... SFA 0022PF Air Filter Set..... SFA 0022SET
ZX350LCK (EXCAVATORS) ISUZU AA-6HK1	Cabin Air Filter..... SFC 50249
ZX350LCK (EXCAVATORS) W/ISUZU AA-6HK1 ENG.	Cabin Air Filter..... SFC 00684
ZX350LCN (EXCAVATORS) ISUZU , 2005	Air Filter Secondary..... SFA 8813S Air Filter Set..... SFA 0022SET Air Filter Primary..... SFA 0022PF Fuel Filter..... SFF 6280 Fuel Filter..... SFF 2631 Hydraulic Oil Filter Suction..... SFH 0224 Hydraulic Oil Filter Return..... SFH 3773 Hydraulic Oil Filter..... SFH 7841



To order, please call:
+1 8448 BE SURE; +1 (925) 566-8863

For Reference Only - May not be a direct cross



Email :
order@suresfilter.us



Engine Application

MODEL/APPLICATION	SURE NO
HITACHI	
ZX370 (EXCAVATORS) ISUZU 6HK1X Cabin Air Filter.....	SFC 50249
ZX370 (EXCAVATORS) ISUZU AA-6HK1X Cabin Air Filter.....	SFC 50249
ZX370 (EXCAVATORS) W/ISUZU AA-6HK1X ENG. Cabin Air Filter.....	SFC 00684
ZX370MTH (EXCAVATORS) ISUZU AA-6HK1XQA , 2002 Air Filter Primary..... Air Filter Set.....	SFA 0022PF SFA 0022SET
ZX370MTH (EXCAVATORS) ISUZU 6HK1X Cabin Air Filter.....	SFC 50249
ZX370MTH (EXCAVATORS) ISUZU AA-6HK1X Cabin Air Filter.....	SFC 50249
ZX370MTH (EXCAVATORS) W/ISUZU AA-6HK1X ENG. Cabin Air Filter.....	SFC 00684
ZX30 (EXCAVATORS) KUBOTA V1505 Air Filter Primary..... Fuel Filter..... Hydraulic Oil Filter..... Hydraulic Oil Filter.....	SFA 1575P SFF 3560 SFH 4132 SFH 4130
ZX30U (EXCAVATORS) ISUZU 3LD2 (S/N: 05001-UP) Air Filter Primary..... Air Filter Secondary..... Fuel Filter..... Hydraulic Oil Filter.....	SFA 1575P SFA 2858S SFF 3560 SFH 4130
ZX30U-2 (EXCAVATORS) YANMAR 3TNV88 (S/N: 010001-UP) , 2006 Air Filter Primary..... Air Filter Secondary..... Hydraulic Oil Filter.....	SFA 1575P SFA 2858S SFH 4130
ZX35 (EXCAVATORS) KUBOTA V1505 Air Filter Primary..... Fuel Filter..... Hydraulic Oil Filter..... Hydraulic Oil Filter.....	SFA 1575P SFF 3560 SFH 4132 SFH 4130
ZX35U-2 (EXCAVATORS) YANMAR 3TNV88 (S/N: 010001-UP) Air Filter Primary..... Air Filter Secondary..... Hydraulic Oil Filter.....	SFA 1575P SFA 2858S SFH 4130
ZX350L (EXCAVATORS) ISUZU 6HK1 Cabin Air Filter.....	SFC 00684

MODEL/APPLICATION	SURE NO
HITACHI	
ZX350LCN (EXCAVATORS) ISUZU 6HK1 Hydraulic Oil Filter Return.....	SFH 3064
ZX350LCN (EXCAVATORS) W/ISUZU AA-6HK1 ENG. Cabin Air Filter.....	SFC 00684
ZX450-3 (EXCAVATORS) ISUZU AH 6WG1 XYS-A-01/20001 , 2006 Cabin Air Filter..... Cabin Air Filter.....	SFC 32683 SFC 32689
ZX450-3 (EXCAVATORS) ISUZU AH 6WG1 XYS-A-01 (S/N: 020001-UP) , 2006 Air Filter Set..... Air Filter Secondary..... Air Filter Primary..... Hydraulic Oil Filter.....	SFA 2180SET SFA 2320S SFA 2180P SFH 6141
ZX450-3 (EXCAVATORS) ISUZU AH-6WG1X Cabin Air Filter.....	SFC 43580
ZX450LC-3 (EXCAVATORS) ISUZU AH 6WG1 XYS-A-01/20001 , 2006 Cabin Air Filter..... Cabin Air Filter.....	SFC 32683 SFC 32689
ZX450LC-3 (EXCAVATORS) ISUZU AH-6WG1X Cabin Air Filter.....	SFC 43580
ZX470H-3 (EXCAVATORS) ISUZU AH 6WG1 XYS-A-01/20001 , 2008 Cabin Air Filter..... Cabin Air Filter.....	SFC 32689 SFC 32683
ZX470H-3 (EXCAVATORS) ISUZU AH-6WG1X Cabin Air Filter.....	SFC 43580
ZX470LCH-3 (EXCAVATORS) ISUZU AH 6WG1 XYS-A-01/20001 , 2008 Cabin Air Filter..... Cabin Air Filter.....	SFC 32689 SFC 32683
ZX470LCH-3 (EXCAVATORS) ISUZU AH 6WG1 XYS-A-01 (S/N: 020001-UP) , 2008 Air Filter Set..... Air Filter Secondary..... Air Filter Primary..... Hydraulic Oil Filter.....	SFA 2180SET SFA 2320S SFA 2180P SFH 6141
ZX470LCH-3 (EXCAVATORS) ISUZU AH-6WG1X Cabin Air Filter.....	SFC 43580
ZX40 (EXCAVATORS) KUBOTA V2203 Air Filter Primary..... Fuel Filter..... Hydraulic Oil Filter..... Hydraulic Oil Filter.....	SFA 1575P SFF 3160 SFH 4132 SFH 4130

MODEL/APPLICATION	SURE NO
HITACHI	
ZX40U (EXCAVATORS) ISUZU 4LE2 (S/N: 1LD-005001-UP) Air Filter Secondary..... Air Filter Primary..... Fuel Filter..... Hydraulic Oil Filter.....	SFA 2858S SFA 1575P SFF 3560 SFH 4130
ZX40U (EXCAVATORS) ISUZU 4LE2 Hydraulic Oil Filter.....	SFH 4132
ZX40U-2 (EXCAVATORS) YANMAR 4TNV88 (S/N: 010001-UP) , 2006 Air Filter Secondary..... Air Filter Primary..... Hydraulic Oil Filter.....	SFA 2858S SFA 1575P SFH 4130
ZX450 (EXCAVATORS) ISUZU 6WG1TQA Air Filter Secondary..... Air Filter Primary..... Air Filter Primary..... Air Filter Set..... Fuel Filter..... Fuel Filter..... Hydraulic Oil Filter..... Hydraulic Oil Filter..... Hydraulic Oil Filter.....	SFA 7869S SFA 78681PF SFA 7868PF SFA 7868SETF SFF 6280 SFF 2631 SFH 6141 SFH 7841 SFH 7634
ZX450 (EXCAVATORS) ISUZU 6WG1T Cabin Air Filter.....	SFC 50249
ZX450LC (EXCAVATORS) ISUZU 6WG1T Cabin Air Filter.....	SFC 50249
ZX460LCH (EXCAVATORS) ISUZU 6WG1T Cabin Air Filter.....	SFC 00684
ZX470-3 (EXCAVATORS) Air Filter Primary..... Air Filter Set..... Air Filter Secondary..... Hydraulic Oil Filter.....	SFA 2180P SFA 2180SET SFA 2320S SFH 6141
ZX480MT (EXCAVATORS) ISUZU 6WG1T Cabin Air Filter.....	SFC 00684
ZX480MTH (EXCAVATORS) ISUZU 6WG1T Cabin Air Filter.....	SFC 00684
ZX500LC-3 (EXCAVATORS) ISUZU AH 6WG1 XYS-A-01/20001 , 2006 Cabin Air Filter..... Cabin Air Filter.....	SFC 32683 SFC 32689
ZX500LC-3 (EXCAVATORS) ISUZU AH 6WG1 XYS-A-01 (S/N: 020001-UP) , 2006 Air Filter Secondary..... Air Filter Primary.....	SFA 2320S SFA 2180P



To order, please call:
+1 8448 BE SURE; +1 (925) 566-8863

For Reference Only - May not be a direct cross



Email :
order@surefilter.us



Engine Application

MODEL/APPLICATION	SURE NO
HITACHI	

ZX500LC-3 (EXCAVATORS) ISUZU AH 6WG1 XYS-A-01 (S/N: 020001-UP) , 2006	Air Filter Set..... SFA 2180SET Hydraulic Oil Filter..... SFH 6141
ZX500LC-3 (EXCAVATORS) ISUZU AH-6WG1X	Cabin Air Filter..... SFC 43580
ZX520LCH-3 (EXCAVATORS) ISUZU AH 6WG1 XYS-A-01/20001 , 2006	Cabin Air Filter..... SFC 32689 Cabin Air Filter..... SFC 32683
ZX520LCH-3 (EXCAVATORS) ISUZU AH 6WG1 XYS-A-01 (S/N: 020001-UP) , 2006	Air Filter Set..... SFA 2180SET Air Filter Secondary..... SFA 2320S Air Filter Primary..... SFA 2180P Hydraulic Oil Filter..... SFH 6141
ZX50 (EXCAVATORS) KUBOTA V2203	Air Filter Primary..... SFA 1575P Fuel Filter..... SFF 3160 Hydraulic Oil Filter..... SFH 4132 Hydraulic Oil Filter..... SFH 4130
ZX500 (EXCAVATORS)	Air Filter Primary..... SFA 78681PF Air Filter Set..... SFA 7868SETF Air Filter Primary..... SFA 7868PF Air Filter Secondary..... SFA 7869S Fuel Filter..... SFF 2631 Fuel Filter..... SFF 6280 Hydraulic Oil Filter..... SFH 6141 Hydraulic Oil Filter..... SFH 7841 Hydraulic Oil Filter..... SFH 7634
ZX500 (EXCAVATORS) ISUZU 4LE2 (S/N: 1LE-005001-UP)	Air Filter Primary..... SFA 1575P Air Filter Secondary..... SFA 2858S Fuel Filter..... SFF 3560 Hydraulic Oil Filter..... SFH 4130
ZX500 (EXCAVATORS) ISUZU 4LE2	Hydraulic Oil Filter..... SFH 4132
ZX500-2 (EXCAVATORS) YANMAR 4TNV88 (S/N: 010001-UP) , 2006	Air Filter Secondary..... SFA 2858S Air Filter Primary..... SFA 1575P Hydraulic Oil Filter..... SFH 4130
ZX520-3 (EXCAVATORS)	Air Filter Primary..... SFA 2180P Air Filter Set..... SFA 2180SET Air Filter Secondary..... SFA 2320S Hydraulic Oil Filter..... SFH 6141

MODEL/APPLICATION	SURE NO
HITACHI	

ZX520LC-3 (EXCAVATORS) ISUZU AH-6WG1X	Cabin Air Filter..... SFC 43580
ZX500LC (EXCAVATORS) ISUZU 6WG1T	Cabin Air Filter..... SFC 50249
ZX650LC-3 (EXCAVATORS) ISUZU AH 6WG1 XYS-A-02/20001 , 2006	Cabin Air Filter..... SFC 32689 Cabin Air Filter..... SFC 32683
ZX650LC-3 (EXCAVATORS) ISUZU AH 6WG1 XYS-A-02 (S/N: 020001-UP) , 2006	Air Filter Secondary..... SFA 2320S Air Filter Primary..... SFA 2180P Air Filter Set..... SFA 2180SET Hydraulic Oil Filter..... SFH 6141
ZX650LC-3 (EXCAVATORS) ISUZU 6WG1X	Cabin Air Filter..... SFC 43580
ZX670LCH-3 (EXCAVATORS) ISUZU AH 6WG1 XYS-A-02/20001 , 2006	Cabin Air Filter..... SFC 32689 Cabin Air Filter..... SFC 32683
ZX670LCH-3 (EXCAVATORS) ISUZU AH 6WG1 XYS-A-02 (S/N: 020001-UP) , 2006	Air Filter Primary..... SFA 2180P Air Filter Set..... SFA 2180SET Air Filter Secondary..... SFA 2320S Hydraulic Oil Filter..... SFH 6141
ZX670LCH-3 (EXCAVATORS) ISUZU 6WG1X	Cabin Air Filter..... SFC 43580
ZX600 (EXCAVATORS) ISUZU 6WG1	Air Filter Primary..... SFA 78681PF Air Filter Secondary..... SFA 7869S Air Filter Primary..... SFA 7868PF Air Filter Set..... SFA 7868SETF Fuel Filter..... SFF 6280 Fuel Filter..... SFF 2631 Hydraulic Oil Filter..... SFH 7841 Hydraulic Oil Filter..... SFH 6141 Hydraulic Oil Filter..... SFH 7634
ZX60USB-3 (EXCAVATORS) 4TNV98	Hydraulic Oil Filter..... SFH 7425
ZX60USB-3 (EXCAVATORS) YANMAR KDN-4TNV98	Hydraulic Oil Filter..... SFH 7425
ZX650 (EXCAVATORS)	Air Filter Primary..... SFA 7868PF Air Filter Set..... SFA 7868SETF Air Filter Primary..... SFA 78681PF

MODEL/APPLICATION	SURE NO
HITACHI	

ZX650 (EXCAVATORS)	Air Filter Secondary..... SFA 7869S Fuel Filter..... SFF 2631 Fuel Filter..... SFF 6280 Hydraulic Oil Filter..... SFH 7634 Hydraulic Oil Filter..... SFH 6141 Hydraulic Oil Filter..... SFH 7841
ZX650-3 (EXCAVATORS) ISUZU 6WG1X	Cabin Air Filter..... SFC 43580
ZX650H (EXCAVATORS) ISUZU 6WG1 XQA01	Air Filter Primary..... SFA 78681PF Air Filter Primary..... SFA 7868PF Air Filter Secondary..... SFA 7869S Air Filter Set..... SFA 7868SETF Fuel Filter..... SFF 2631 Hydraulic Oil Filter..... SFH 7634 Hydraulic Oil Filter..... SFH 6141 Hydraulic Oil Filter..... SFH 7841
ZX650LCH (EXCAVATORS) ISUZU BB6WG , 2001	Air Filter Primary..... SFA 78681PF Air Filter Primary..... SFA 7868PF Air Filter Secondary..... SFA 7869S Air Filter Set..... SFA 7868SETF Fuel Filter..... SFF 2631 Hydraulic Oil Filter..... SFH 7841 Hydraulic Oil Filter..... SFH 7634
ZX670-3 (EXCAVATORS)	Air Filter Primary..... SFA 2180P Air Filter Set..... SFA 2180SET Air Filter Secondary..... SFA 2320S Hydraulic Oil Filter..... SFH 6141
ZX60-5G (EXCAVATORS) 4TNV98-07559	Air Filter Set..... SFA Y541SET Air Filter Primary..... SFA Y541PF
ZX65USB-5A (EXCAVATORS) 4TNV94L-ZWHB , 3000, 2015	Air Filter Secondary..... SFA 6509S
ZX60USB-3F (EXCAVATORS) YANMAR 4TNV98	Hydraulic Oil Filter..... SFH 7425
ZX65USB-5 (EXCAVATORS) YANMAR 4TNV94-ZWHB , 3000, 2015	Hydraulic Oil Filter..... SFH 7425
ZX70 (EXCAVATORS) ISUZU AA-4JG1	Cabin Air Filter..... SFC 50249
ZX70 (EXCAVATORS)	



To order, please call:
+1 8448 BE SURE; +1 (925) 566-8863

For Reference Only - May not be a direct cross



Email :
order@suresfilter.us



Engine Application

MODEL/APPLICATION	SURE NO
HITACHI	

MODEL/APPLICATION	SURE NO
HITACHI	

MODEL/APPLICATION	SURE NO
HITACHI	

ZX70
(EXCAVATORS)

Air Filter Primary.....	SFA 5436P
Air Filter Secondary.....	SFA 2769S
Fuel Filter.....	SFF 2001
Hydraulic Oil Filter.....	SFH 7841
Oil Filter Full Flow.....	SFO 9708
Oil Filter Full Flow.....	SFO 178A

ZX70LC
(EXCAVATORS)
ISUZU AA-4JG1

Air Filter Secondary.....	SFA 2769S
Air Filter Primary.....	SFA 5436P
Cabin Air Filter.....	SFC 50249
Fuel Filter.....	SFF 2001
Fuel Filter.....	SFF 6280
Hydraulic Oil Filter.....	SFH 7841
Oil Filter Full Flow.....	SFO 178A
Oil Filter Full Flow.....	SFO 9708

ZX75UR
(EXCAVATORS)
ISUZU 4JG1

Fuel Filter.....	SFF 0057
------------------	----------

ZX75UR
(EXCAVATORS)
ISUZU CC-4JG1 (S/N: 040001-UP)

Air Filter Primary.....	SFA 5436P
Air Filter Secondary.....	SFA 2769S
Fuel Filter.....	SFF 2001
Hydraulic Oil Filter.....	SFH 7841
Oil Filter Full Flow.....	SFO 178A
Oil Filter Full Flow.....	SFO 9708

ZX75US
(EXCAVATORS)
, 2008

Air Filter Secondary.....	SFA 2769S
Air Filter Primary.....	SFA 5436P
Fuel Filter.....	SFF 6280
Fuel Filter.....	SFF 2001
Hydraulic Oil Filter.....	SFH 7841
Oil Filter Full Flow.....	SFO 178A
Oil Filter Full Flow.....	SFO 9708

ZX75US
(EXCAVATORS)
ISUZU 4JG1

Air Filter Secondary.....	SFA 2769S
Air Filter Primary.....	SFA 5436P
Cabin Air Filter.....	SFC 50249
Fuel Filter.....	SFF 2001
Hydraulic Oil Filter.....	SFH 7841
Oil Filter Full Flow.....	SFO 178A
Oil Filter Full Flow.....	SFO 9708

ZX75US-A
(EXCAVATORS)
ISUZU AA-4JG1 , 2006

Hydraulic Oil Filter.....	SFH 7425
---------------------------	----------

ZX850LC-3
(EXCAVATORS)
ISUZU AH 6WG1 XYS-A-03/20001 , 2006

Air Filter Set.....	SFA 0022SET
Air Filter Primary.....	SFA 0022PF
Cabin Air Filter.....	SFC 32683

ZX850LC-3
(EXCAVATORS)
ISUZU AH 6WG1 XYS-A-03/20001 , 2006

Cabin Air Filter.....	SFC 32689
-----------------------	-----------

ZX850LC-3
(EXCAVATORS)
ISUZU AH 6WG1 XYS-A-03 (S/N: 020001-UP) , 2006

Air Filter Set.....	SFA 0022SET
Air Filter Primary.....	SFA 0022PF
Air Filter Secondary.....	SFA 8813S
Hydraulic Oil Filter.....	SFH 6141

ZX850LC-3
(EXCAVATORS)
ISUZU 6WG1X

Cabin Air Filter.....	SFC 43580
-----------------------	-----------

ZX870LCH-3
(EXCAVATORS)
ISUZU AH 6WG1 XYS-A-03/20001 , 2006

Air Filter Set.....	SFA 0022SET
Air Filter Primary.....	SFA 0022PF
Cabin Air Filter.....	SFC 32689
Cabin Air Filter.....	SFC 32683

ZX870LCH-3
(EXCAVATORS)
ISUZU AH 6WG1 XYS-A-03 (S/N: 020001-UP) , 2006

Air Filter Secondary.....	SFA 8813S
Air Filter Set.....	SFA 0022SET
Air Filter Primary.....	SFA 0022PF
Hydraulic Oil Filter.....	SFH 6141

ZX870LCH-3
(EXCAVATORS)
ISUZU 6WG1X

Cabin Air Filter.....	SFC 43580
-----------------------	-----------

ZX80
(EXCAVATORS)
ISUZU AA-4JG1

Air Filter Secondary.....	SFA 2769S
Air Filter Primary.....	SFA 5436P
Fuel Filter.....	SFF 6280
Fuel Filter.....	SFF 2001
Hydraulic Oil Filter.....	SFH 7841
Oil Filter Full Flow.....	SFO 9708
Oil Filter Full Flow.....	SFO 178A

ZX80
(EXCAVATORS)
ISUZU CC-4JG1

Cabin Air Filter.....	SFC 50249
-----------------------	-----------

ZX80SB
(EXCAVATORS)
ISUZU AA-4JG1

Air Filter Secondary.....	SFA 2769S
Air Filter Primary.....	SFA 5436P
Fuel Filter.....	SFF 6280
Fuel Filter.....	SFF 2001
Hydraulic Oil Filter.....	SFH 7841
Oil Filter Full Flow.....	SFO 9708
Oil Filter Full Flow.....	SFO 178A

ZX8-2
(EXCAVATORS)
YANMAR 3TNV70 , 2008

Hydraulic Oil Filter.....	SFH 4130
---------------------------	----------

ZX850
(EXCAVATORS)
ISUZU 6WG1

Air Filter Secondary.....	SFA 2320S
---------------------------	-----------

ZX850
(EXCAVATORS)
ISUZU 6WG1

Air Filter Primary.....	SFA 2180P
Air Filter Set.....	SFA 2180SET
Cabin Air Filter.....	SFC 50249
Fuel Filter.....	SFF 2631
Fuel Filter.....	SFF 6280
Hydraulic Oil Filter.....	SFH 6141
Hydraulic Oil Filter.....	SFH 7841

ZX850H
(EXCAVATORS)

Air Filter Secondary.....	SFA 2320S
Fuel Filter.....	SFF 2631

ZX85US
(EXCAVATORS)
ISUZU 4JG1

Air Filter Secondary.....	SFA 2769S
Air Filter Primary.....	SFA 5436P
Cabin Air Filter.....	SFC 50249
Fuel Filter.....	SFF 2001
Fuel Filter.....	SFF 6280
Hydraulic Oil Filter.....	SFH 7841
Oil Filter Full Flow.....	SFO 178A
Oil Filter Full Flow.....	SFO 9708

ZX870-3
(EXCAVATORS)
, 2006

Air Filter Set.....	SFA 0022SET
Air Filter Primary.....	SFA 0022PF
Air Filter Secondary.....	SFA 8813S
Hydraulic Oil Filter.....	SFH 6141

ZX870H-3
(EXCAVATORS)
ISUZU 6WG1X

Cabin Air Filter.....	SFC 43580
-----------------------	-----------

ZX85USB-5A
(EXCAVATORS)
4TNV94L , 3000, 2015

Air Filter Secondary.....	SFA 6509S
---------------------------	-----------

ZX850-3
(EXCAVATORS)
ISUZU 6WG1X

Cabin Air Filter.....	SFC 43580
-----------------------	-----------

ZZ270LC
(EXCAVATORS)
ISUZU 6BG1

Fuel Filter.....	SFF 2564
------------------	----------



















PRODUCT GUIDE

B

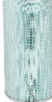

Product Guide

<p>SFA 0022PF</p>  <p>CONT : 1 VOL : 0.047</p>	<p>Air Filter Primary Soft PU end cap Element With Sleeve</p> <p>VOLVO 11110022 HITACHI 4459549</p> <p>Secondary Filter uses SFA 7414S Set Filter uses SFA 0022SET H 1 : 522 (mm) H 2 : 510 (mm) OD 1 : 280 (mm) OD 2 : 280 (mm) ID 1 : 148 (mm)</p>	<p>SFA 0490S</p>  <p>CONT : 9 VOL : 0.085</p>	<p>Air Filter Secondary Metal End Cap Element</p> <p>ISUZU 1-14215047-0 ISUZU 1-1425-046-1 NISSAN 16546-96010</p> <p>Primary Filter uses SFA 3113P Set Filter uses SFA 6050SET H 1 : 330 (mm) OD 1 : 146 (mm) OD 2 : 116.5 (mm) ID 1 : 88 (mm) ID 2 : 17 (mm)</p>	<p>SFA 1035</p>  <p>CONT : 4 VOL : 0.072</p>	<p>Air Filter Metal End Cap Element</p> <p>CUMMINS 158877</p> <p>H 1 : 267 (mm) H 2 : 254 (mm) OD 1 : 234 (mm) OD 2 : 234 (mm) ID 1 : 123 (mm) ID 2 : 14 (mm)</p> <p>Note : with fins version uses SFA 1035F</p>
<p>SFA 0022SET</p>  <p>CONT : 1 VOL : 0.049</p>	<p>Air Filter Set Soft PU end cap Element With Sleeve</p> <p>VOLVO 11110022+11110023</p> <p>Primary Filter uses SFA 0022PF Secondary Filter uses SFA 7414S H 1 : 522 (mm) H 2 : 510 (mm) OD 1 : 280 (mm) OD 2 : 280 (mm) ID 1 : 148 (mm)</p>	<p>SFA 0678S</p>  <p>CONT : 9 VOL : 0.103</p>	<p>Air Filter Secondary Metal End Cap Element</p> <p>MASSEY-FERGUSON 3580724M1 LIEBHERR 7403951 JOHN DEERE RE42762</p> <p>Primary Filter uses SFA 1531PF Set Filter uses SFA 1531SET H 1 : 394 (mm) H 2 : 381 (mm) OD 1 : 151 (mm) OD 2 : 151 (mm) ID 1 : 123 (mm) ID 2 : 17 (mm)</p>	<p>SFA 1035F</p>  <p>CONT : 1 VOL : 0.028</p>	<p>Air Filter Metal End Cap Element With Sleeve</p> <p>CUMMINS 158877 CUMMINS 299353</p> <p>H 1 : 267 (mm) H 2 : 254 (mm) OD 1 : 296 (mm) OD 2 : 234 (mm) ID 1 : 123 (mm) ID 2 : 14 (mm)</p> <p>Note : Sleeve on E/C "B" type uses SFA 8343F</p>
<p>SFA 0418P</p>  <p>CONT : 4 VOL : 0.098</p>	<p>Air Filter Primary Metal End Cap Element</p> <p>FIAT 0068473-3 ISUZU 1-14215-018-0 ISUZU 1-14215007-0 NISSAN 16546-96011</p> <p>Secondary Filter uses SFA 0490S Set Filter uses SFA 6029SET H 1 : 343 (mm) H 2 : 330 (mm) OD 1 : 234 (mm) OD 2 : 234 (mm) ID 1 : 123 (mm) ID 2 : 17 (mm)</p>	<p>SFA 0760PF</p>  <p>CONT : 9 VOL : 0.105</p>	<p>Air Filter Primary Metal End Cap Element With Sleeve</p> <p>CATERPILLAR 3I-0228 FIAT 79022025</p> <p>Secondary Filter uses SFA 3776S Set Filter uses SFA 0760SET H 1 : 316 (mm) H 2 : 305 (mm) OD 1 : 160 (mm) OD 2 : 133.5 (mm) ID 1 : 82 (mm) ID 2 : 17 (mm)</p>	<p>SFA 1042P</p>  <p>CONT : 1 VOL : 0.103</p>	<p>Air Filter Primary Metal End Cap Element</p> <p>CUMMINS 3013212 CATERPILLAR 3I-0795 HITACHI 4206272</p> <p>Secondary Filter uses SFA 8408S Set Filter uses SFA 1042SET H 1 : 623 (mm) H 2 : 610 (mm) OD 1 : 373 (mm) OD 2 : 373 (mm) ID 1 : 263 (mm) ID 2 : 23 (mm)</p>
<p>SFA 0434PF</p>  <p>CONT : 1 VOL : 0.031</p>	<p>Air Filter Primary Metal End Cap Element With Sleeve</p> <p>NISSAN 16546-96003 NISSAN 16546-96015 NISSAN 16546-96026</p> <p>Secondary Filter uses SFA 0804S Set Filter uses SFA 0434SET H 1 : 419 (mm) H 2 : 406 (mm) OD 1 : 254 (mm) OD 2 : 201.5 (mm) ID 1 : 135.5 (mm) ID 2 : 17 (mm)</p>	<p>SFA 0857S</p>  <p>CONT : 1 VOL : 0.048</p>	<p>Air Filter Secondary Metal End Cap Element</p> <p>WABCO 4078928 HITACHI 4331920 CATERPILLAR 9Y-7663</p> <p>Primary Filter uses SFA 0879P Set Filter uses SFA 0879SET H 1 : 563 (mm) H 2 : 550.6 (mm) OD 1 : 276 (mm) OD 2 : 276 (mm) ID 1 : 207.5 (mm) ID 2 : 23 (mm)</p>	<p>SFA 1045F</p>  <p>CONT : 1 VOL : 0.022</p>	<p>Air Filter Metal End Cap Element With Sleeve</p> <p>ISUZU 14215-132 CUMMINS 158876 NISSAN 16546-Z5001</p> <p>H 1 : 267 (mm) H 2 : 254 (mm) OD 1 : 257 (mm) OD 2 : 201.5 (mm) ID 1 : 90.5 (mm) ID 2 : 14 (mm)</p> <p>Note : ID=91/17 mm uses SFA 1534F</p>
<p>SFA 0434SET</p>  <p>CONT : 4 VOL : 0.134</p>	<p>Air Filter Set Metal End Cap Element With Sleeve</p> <p>FIAT 1930751+1930790 KOMATSU 6131-82-7011 FIAT 70684732+1930790 JOHN DEERE T46316+T46317</p> <p>Primary Filter uses SFA 0434PF Secondary Filter uses SFA 0804S H 1 : 419 (mm) H 2 : 406 (mm) OD 1 : 254 (mm) OD 2 : 201.5 (mm) ID 1 : 135.5 (mm) ID 2 : 17 (mm)</p>	<p>SFA 0883S</p>  <p>CONT : 4 VOL : 0.106</p>	<p>Air Filter Secondary Metal End Cap Element</p> <p>CATERPILLAR 1N-8164 CATERPILLAR 4N-9164 INGERSOLL RAND 50616408</p> <p>Primary Filter uses SFA 0851P Set Filter uses SFA 0851SET H 1 : 433 (mm) H 2 : 423 (mm) OD 1 : 220 (mm) OD 2 : 220 (mm) ID 1 : 179 (mm) ID 2 : 23 (mm)</p>	<p>SFA 1046P</p>  <p>CONT : 4 VOL : 0.173</p>	<p>Air Filter Primary Metal End Cap Element</p> <p>ISUZU 1-14215046-0 NISSAN 16546-96017 FIAT 1901779</p> <p>Secondary Filter uses SFA 9373S Set Filter uses SFA 3800SET H 1 : 419 (mm) H 2 : 406 (mm) OD 1 : 282 (mm) OD 2 : 282 (mm) ID 1 : 171 (mm) ID 2 : 17 (mm)</p>



To order, please call:
+1 8448 BE SURE; +1 (925) 566-8863















FOR REFERENCE ONLY - REPRESENTATIVE PICTURE ONLY



Email :
order@surefilter.us



Product Guide

<p>SFA 1050PF</p> <p>Air Filter Primary Metal End Cap Element With Sleeve</p> <p>ISUZU 1-14215014-0 YANMAR 121120-12901 KUBOTA 121420-12511</p>  <p>Secondary Filter uses SFA 1278S Set Filter uses SFA 1050SET H 1 : 264 (mm) H 2 : 254 (mm) OD 1 : 132 (mm) OD 2 : 104 (mm) ID 1 : 63 (mm) ID 2 : 17 (mm)</p> <p>CONT : 12 VOL : 0.073</p>	<p>SFA 1073P</p> <p>Air Filter Primary Metal End Cap Element</p> <p>ISUZU 1-14215116-0 ISUZU 1-14215117-0 ISUZU 1-14215128-0</p>  <p>Secondary Filter uses SFA 7313S Set Filter uses SFA 1073SET H 1 : 496 (mm) H 2 : 483 (mm) OD 1 : 307 (mm) OD 2 : 307 (mm) ID 1 : 196 (mm) ID 2 : 23 (mm)</p> <p>CONT : 1 VOL : 0.058</p>	<p>SFA 1531PF</p> <p>Air Filter Primary Metal End Cap Element With Sleeve</p> <p>FIAT 1930602 DAEWOO 2471-9023 FIAT 70005585</p>  <p>Secondary Filter uses SFA 0678S Set Filter uses SFA 1531SET H 1 : 420 (mm) H 2 : 407 (mm) OD 1 : 296 (mm) OD 2 : 317 (mm) ID 1 : 153 (mm) ID 2 : 15 (mm)</p> <p>CONT : 1 VOL : 0.053</p>
<p>SFA 1052PF</p> <p>Air Filter Primary Metal End Cap Element With Sleeve</p> <p>ISUZU 1-14215135-0 KUBOTA 15606-11080 YANMAR 171064-12540</p>  <p>Secondary Filter uses SFA 3160S Set Filter uses SFA 1052SET H 1 : 288 (mm) H 2 : 279 (mm) OD 1 : 160 (mm) OD 2 : 134 (mm) ID 1 : 66.5 (mm) ID 2 : 17 (mm)</p> <p>CONT : 9 VOL : 0.096</p>	<p>SFA 1080P</p> <p>Air Filter Primary Metal End Cap Element</p> <p>ISUZU 1-14214108-0 ISUZU 1-14214153-0 ISUZU 1-14215060-0 NISSAN 16546-Z9010 TOYOTA 17801-2560</p>  <p>Secondary Filter uses SFA 7315S Set Filter uses SFA 9025SET H 1 : 343 (mm) H 2 : 330 (mm) OD 1 : 232 (mm) OD 2 : 232 (mm) ID 1 : 147 (mm) ID 2 : 23 (mm)</p> <p>CONT : 4 VOL : 0.094</p>	<p>SFA 1531SET</p> <p>Air Filter Set Metal End Cap Element With Sleeve</p> <p>HITACHI 71420350 + 1930792</p>  <p>Primary Filter uses SFA 1531PF Secondary Filter uses SFA 0678S H 1 : 420 (mm) H 2 : 381 (mm) OD 1 : 296 (mm) OD 2 : 317 (mm) ID 1 : 153 (mm) ID 2 : 15 (mm)</p> <p>CONT : 1 VOL : 0.053</p>
<p>SFA 1054P</p> <p>Air Filter Primary Metal End Cap Element</p> <p>CHRYSLER 3614353 KOMATSU 600-181-8240</p>  <p>Secondary Filter uses SFA 1394S Set Filter uses SFA 1054PSET H 1 : 311 (mm) H 2 : 305 (mm) OD 1 : 155 (mm) OD 2 : 155 (mm) ID 1 : 88 (mm) ID 2 : 17 (mm)</p> <p>CONT : 4 VOL : 0.047</p>	<p>SFA 1087P</p> <p>Air Filter Primary Metal End Cap Element</p> <p>ATLAS COPCO 1619-27-98-00 DEUTZ 2165041 DEUTZ 2165054</p>  <p>Secondary Filter uses SFA 1200S Set Filter uses SFA 4401SET H 1 : 384 (mm) H 2 : 371 (mm) OD 1 : 228 (mm) OD 2 : 228 (mm) ID 1 : 117 (mm) ID 2 : 11 (mm)</p> <p>CONT : 1 VOL : 0.026</p> <p>Note :</p>	<p>SFA 1555PF</p> <p>Air Filter Primary Metal End Cap Element With Sleeve</p> <p>FIAT 1930603 FIAT 71415282</p>  <p>Secondary Filter uses SFA 4589S Set Filter uses SFA 1555SET H 1 : 420 (mm) H 2 : 407.5 (mm) OD 1 : 254 (mm) OD 2 : 278.5 (mm) ID 1 : 135.5 (mm) ID 2 : 15 (mm)</p> <p>CONT : 1 VOL : 0.038</p>
<p>SFA 1054PF</p> <p>Air Filter Primary Metal End Cap Element With Sleeve</p> <p>MAZDA 0727-23-603 ISUZU 1-14215028-0 ISUZU 1-14215032-0</p>  <p>Secondary Filter uses SFA 1394S Set Filter uses SFA 1054SET H 1 : 311 (mm) H 2 : 305 (mm) OD 1 : 199 (mm) OD 2 : 155 (mm) ID 1 : 88 (mm) ID 2 : 17 (mm)</p> <p>CONT : 12 VOL : 0.211</p>	<p>SFA 1240F</p> <p>Air Filter Metal End Cap Element With Sleeve</p> <p>CUMMINS 158871 CUMMINS 158878 NISSAN 16546-M0800 MITSUBISHI 31230-60600 ISUZU 9-14215129-0</p>  <p>H 1 : 318 (mm) H 2 : 305 (mm) OD 1 : 352 (mm) OD 2 : 282 (mm) ID 1 : 171 (mm) ID 2 : 13.5 (mm)</p> <p>CONT : 1 VOL : 0.047</p>	<p>SFA 1555SET</p> <p>Air Filter Set Metal End Cap Element With Sleeve</p> <p>FIAT 1930603+1930790</p>  <p>Primary Filter uses SFA 1555PF Secondary Filter uses SFA 4589S H 1 : 420 (mm) H 2 : 407.5 (mm) OD 1 : 254 (mm) OD 2 : 278.5 (mm) ID 1 : 135.5 (mm) ID 2 : 15 (mm)</p> <p>CONT : 1 VOL : 0.038</p>
<p>SFA 1054PSET</p> <p>Air Filter Set Metal End Cap Element</p> <p>CLAAS 3200010+3200020 BLOUNT 537986+537987 BOBCAT 6681474+6681475 JOHN DEERE AT44377+AT44378</p>  <p>Primary Filter uses SFA 1054P Secondary Filter uses SFA 1394S H 1 : 311 (mm) H 2 : 305 (mm) OD 1 : 155 (mm) OD 2 : 155 (mm) ID 1 : 88 (mm) ID 2 : 17 (mm)</p> <p>CONT : 4 VOL : 0.043</p>	<p>SFA 1278S</p> <p>Air Filter Secondary Metal End Cap Element</p> <p>KUBOTA 121422-12570 YANMAR 121422-12570 KUBOTA 15287-11490 CASE 167817A1 HITACHI 4311871</p>  <p>Primary Filter uses SFA 1050PF Set Filter uses SFA 1050SET H 1 : 232 (mm) H 2 : 228.5 (mm) OD 1 : 62.5 (mm) OD 2 : 62.5 (mm) ID 1 : 49 (mm) ID 2 : 17 (mm)</p> <p>CONT : 25 VOL : 0.038</p>	<p>SFA 1575P</p> <p>Air Filter Primary Soft PU end cap Element</p> <p>YANMAR 119808-12520 NISSAN 16546-FJ100 KOMATSU 3EB-02-38730 SUNWARD 730403000157 KUBOTA TA040-93230</p>  <p>Secondary Filter uses SFA 2858S Set Filter uses SFA 2858SET H 1 : 273.5 (mm) H 2 : 265 (mm) OD 1 : 104 (mm) OD 2 : 104 (mm) ID 1 : 61 (mm)</p> <p>CONT : 16 VOL : 0.077</p>



To order, please call:
+1 8448 BE SURE; +1 (925) 566-8863















FOR REFERENCE ONLY - REPRESENTATIVE PICTURE ONLY



Email :
order@surefilter.us



Product Guide

<p>SFA 1680S</p> <p>Air Filter Secondary Metal End Cap Element</p> <p>YANMAR 119131-12520 ISUZU 14215-167 DAEWOO 2474-9014</p>  <p>Primary Filter uses SFA 1733PF</p> <p>H 1 : 336 (mm) H 2 : 330 (mm) OD 1 : 85.5 (mm) OD 2 : 85.5 (mm) ID 1 : 57.5 (mm) ID 2 : 17 (mm)</p> <p>CONT : 25 VOL : 0.106</p> <p>Note : Is a Secondary Air filter for SFA 1733PF,SFA 1733P</p>	<p>SFA 2214SET</p> <p>Air Filter Set Metal End Cap Element</p> <p>HYUNDAI 11N8-22140+11N8-22150</p>  <p>Primary Filter uses SFA 2214P Secondary Filter uses SFA 2215S</p> <p>H 1 : 503 (mm) H 2 : 490 (mm) OD 1 : 276 (mm) OD 2 : 275 (mm) ID 1 : 134 (mm) ID 2 : 19 (mm)</p> <p>CONT : 1 VOL : 0.045</p>	<p>SFA 2530P</p> <p>Air Filter Primary Metal End Cap Element</p> <p>CATERPILLAR 099-5801 ISUZU 1-14215084-0 HINO 17720-3640</p>  <p>Secondary Filter uses SFA 4046S Set Filter uses SFA 8600SET</p> <p>H 1 : 470 (mm) H 2 : 457 (mm) OD 1 : 232 (mm) OD 2 : 232 (mm) ID 1 : 147 (mm) ID 2 : 23 (mm)</p> <p>CONT : 4 VOL : 0.125</p>
<p>SFA 1908S</p> <p>Air Filter Secondary Soft PU end cap Element</p> <p>HITACHI 4287060 KOBELCO YN02P000013B</p>  <p>Primary Filter uses SFA 3861P</p> <p>H 1 : 353 (mm) H 2 : 347 (mm) OD 1 : 126 (mm) OD 2 : 117 (mm) ID 1 : 104 (mm)</p> <p>CONT : 16 VOL : 0.124</p>	<p>SFA 2320S</p> <p>Air Filter Secondary Metal End Cap Element</p> <p>ISUZU 1-14215081-0 CATERPILLAR 3I-0203 HITACHI 4240295</p>  <p>Primary Filter uses SFA 2180P Set Filter uses SFA 2180SET</p> <p>H 1 : 597 (mm) H 2 : 584 (mm) OD 1 : 185 (mm) OD 2 : 185 (mm) ID 1 : 157.5 (mm) ID 2 : 17 (mm)</p> <p>CONT : 1 VOL : 0.026</p>	<p>SFA 2745PF</p> <p>Air Filter Metal End Cap Element With Sleeve</p> <p>YANMAR 124066-12510 ISEKI 1427-101-2840-0 KUBOTA 15221-11223</p>  <p>H 1 : 185 (mm) H 2 : 178 (mm) OD 1 : 109.4 (mm) OD 2 : 83 (mm) ID 1 : 45 (mm) ID 2 : 15 (mm)</p> <p>CONT : 25 VOL : 0.079</p>
<p>SFA 2180P</p> <p>Air Filter Primary Metal End Cap Element</p> <p>ISUZU 1-14125082-0 ISUZU 1-14215082-0 CATERPILLAR 3I-0202</p>  <p>Secondary Filter uses SFA 2320S Set Filter uses SFA 2180SET</p> <p>H 1 : 622 (mm) H 2 : 609.5 (mm) OD 1 : 307 (mm) OD 2 : 307 (mm) ID 1 : 196 (mm) ID 2 : 22.7 (mm)</p> <p>CONT : 1 VOL : 0.072</p>	<p>SFA 2363P</p> <p>Air Filter Primary Soft PU end cap Element</p> <p>JOHN DEERE F434394 CASE IH275809A1</p>  <p>Secondary Filter uses SFA 8813S Set Filter uses SFA 2363SET</p> <p>H 1 : 524 (mm) H 2 : 512 (mm) OD 1 : 280 (mm) OD 2 : 280 (mm) ID 1 : 148 (mm)</p> <p>CONT : 1 VOL : 0.048</p> <p>Note : Is a long life version of SFA 0948P</p>	<p>SFA 2769S</p> <p>Air Filter Secondary Soft PU end cap Element</p> <p>KUBOTA 119005-12571 CASE 133721A1 HITACHI 4326841</p>  <p>Primary Filter uses SFA 5436P Set Filter uses SFA 2768SET</p> <p>H 1 : 303.5 (mm) H 2 : 298 (mm) OD 1 : 83 (mm) OD 2 : 79 (mm) ID 1 : 64 (mm)</p> <p>CONT : 25 VOL : 0.085</p> <p>Note : Is a Secondary Air filter for SFA 0750P,SFA 5436P</p>
<p>SFA 2180SET</p> <p>Air Filter Set Metal End Cap Element</p> <p>HITACHI 4240294+4240295 KOMATSU 561-02-12330+561-02-12320</p>  <p>Primary Filter uses SFA 2180P Secondary Filter uses SFA 2320S</p> <p>H 1 : 622 (mm) H 2 : 609.5 (mm) OD 1 : 307 (mm) OD 2 : 307 (mm) ID 1 : 196 (mm) ID 2 : 22.7 (mm)</p> <p>CONT : 1 VOL : 0.072</p>	<p>SFA 2363SET</p> <p>Air Filter Set Soft PU end cap Element</p> <p>JOHN DEERE F434394 + F434395</p>  <p>Primary Filter uses SFA 2363P Secondary Filter uses SFA 8813S</p> <p>H 1 : 524 (mm) H 2 : 512 (mm) OD 1 : 280 (mm) OD 2 : 280 (mm) ID 1 : 148 (mm)</p> <p>CONT : 1 VOL : 0.045</p> <p>Note : Is a long life version of SFA 0948SET</p>	<p>SFA 2858S</p> <p>Air Filter Secondary Soft PU end cap Element</p> <p>VOLVO 11801160 CATERPILLAR 1467473 LIUGONG 40C0445 JOHN DEERE M131803 KOMATSU YM12905112530</p>  <p>Primary Filter uses SFA 1575P Set Filter uses SFA 2858SET</p> <p>H 1 : 265 (mm) H 2 : 259 (mm) OD 1 : 61 (mm) OD 2 : 59 (mm) ID 1 : 45 (mm)</p> <p>CONT : 25 VOL : 0.050</p>
<p>SFA 2214P</p> <p>Air Filter Primary Metal End Cap Element</p> <p>HYUNDAI 11N8-22140</p>  <p>Secondary Filter uses SFA 2215S Set Filter uses SFA 2214SET</p> <p>H 1 : 503 (mm) H 2 : 490 (mm) OD 1 : 276 (mm) OD 2 : 275 (mm) ID 1 : 165 (mm) ID 2 : 19 (mm)</p> <p>CONT : 1 VOL : 0.045</p>	<p>SFA 24901SET</p> <p>Air Filter Set Metal End Cap Element</p> <p>HINO 17801-2490+17801-3050</p>  <p>Primary Filter uses SFA 2490P Secondary Filter uses SFA 0305S</p> <p>H 1 : 493 (mm) H 2 : 480 (mm) OD 1 : 307 (mm) OD 2 : 307 (mm) ID 1 : 196 (mm) ID 2 : 23 (mm)</p> <p>CONT : 1 VOL : 0.054</p>	<p>SFA 3113P</p> <p>Air Filter Primary Metal End Cap Element</p> <p>KOBELCO 2451-U311-3 DAEWOO 2474-6006A DAEWOO 2474-6006B KOMATSU 600-181-6550</p>  <p>Secondary Filter uses SFA 0490S Set Filter uses SFA 6050SET</p> <p>H 1 : 394 (mm) H 2 : 381 (mm) OD 1 : 235 (mm) OD 2 : 187 (mm) ID 1 : 120 (mm) ID 2 : 17 (mm)</p> <p>CONT : 4 VOL : 0.012</p>



To order, please call:
+1 8448 BE SURE; +1 (925) 566-8863

FOR REFERENCE ONLY - REPRESENTATIVE PICTURE ONLY



Email :
order@surefilter.us



Product Guide

SFA 31302P Air Filter Primary Metal End Cap Element
MITSUBISHI ME 063130

H 1 : 395 (mm)
H 2 : 382 (mm)
OD 1 : 276 (mm)
OD 2 : 276 (mm)
ID 1 : 165 (mm)
ID 2 : 23 (mm)

CONT : 1
VOL : 0.035

Note : Flame Retardant version from SFA 3130P

SFA 3861P Air Filter Primary Soft PU end cap Element
HITACHI 4283861
KOBELCO YN02P000013A



Secondary Filter uses SFA 1908S
Set Filter uses SFA 6158SET
H 1 : 367.5 (mm)
H 2 : 355.5 (mm)
OD 1 : 207 (mm)
OD 2 : 208 (mm)
ID 1 : 124 (mm)

CONT : 4
VOL : 0.081

SFA 42122SET Air Filter Set Metal End Cap Element
HITACHI 4642122+4642117



Primary Filter uses SFA 42122P
Secondary Filter uses SFA 42117S
H 1 : 367 (mm)
H 2 : 341.5 (mm)
OD 1 : 227.5 (mm)
ID 1 : 143 (mm)

CONT : 0
VOL : 0.000

Note : For HITACHI ZX170W-3 2017

SFA 3130P Air Filter Primary Metal End Cap Element



ISUZU 1-14214126-0
ISUZU 1-14215-181-0
ISUZU 1-86750-309-0
NISSAN 16546-96071
NISSAN 16546-99218

Secondary Filter uses SFA 7599S
Set Filter uses SFA 6070SET
H 1 : 395 (mm)
H 2 : 382 (mm)
OD 1 : 276 (mm)
OD 2 : 276 (mm)
ID 1 : 165 (mm)
ID 2 : 23 (mm)

CONT : 1
VOL : 0.036

Note : Is a Primary Air Filter for SFA 7599S,SFA 4354S

SFA 4046S Air Filter Secondary Metal End Cap Element



ISUZU 1-14215085-0
HINO 17801-2460
CATERPILLAR 3I-0179

Primary Filter uses SFA 2530P
Set Filter uses SFA 8600SET
H 1 : 445 (mm)
H 2 : 432 (mm)
OD 1 : 145 (mm)
OD 2 : 145 (mm)
ID 1 : 116.5 (mm)
ID 2 : 23 (mm)

CONT : 9
VOL : 0.108

SFA 4589S Air Filter Secondary Metal End Cap Element



NISSAN 16546-Z5003
ATLAS COPCO 3216-708202
CATERPILLAR 3I-0069
JOHN DEERE T46317

Primary Filter uses SFA 4905P
Set Filter uses SFA 4905SET
H 1 : 387 (mm)
H 2 : 381 (mm)
OD 1 : 116 (mm)
OD 2 : 116 (mm)
ID 1 : 88 (mm)
ID 2 : 17 (mm)

CONT : 16
VOL : 0.117

SFA 3189P Air Filter Primary Metal End Cap Element



JOHN DEERE AR76766
HITACHI AR80652
JOHN DEERE AR80652

Secondary Filter uses SFA 6319S
Set Filter uses SFA 3189SET
H 1 : 503 (mm)
H 2 : 493 (mm)
OD 1 : 231 (mm)
OD 2 : 231 (mm)
ID 1 : 132 (mm)
ID 2 : 10 (mm)

CONT : 4
VOL : 0.135

SFA 4103S Air Filter Secondary Metal End Cap Element



MASSEY-FERGUSON 1093683M91
FIAT-ALLIS 1909964
IVECO 8015449

Primary Filter uses SFA 2801PF
Set Filter uses SFA 2801SET
H 1 : 357 (mm)
H 2 : 355.5 (mm)
OD 1 : 105 (mm)
OD 2 : 85.5 (mm)
ID 1 : 73.5 (mm)
ID 2 : 17 (mm)

CONT : 9
VOL : 0.059

Note : Is a Secondary Air filter for SFA 2801PF,SFA 1733PF,SFA 0262PF

SFA 4723PF Air Filter Primary Metal End Cap Element With Sleeve



CASE 167815A1
KOMATSU 37Z-02-AF934A
KOMATSU 3EA-01-18130
HITACHI 4294846
J.C.BAMFORD KAP0482

Secondary Filter uses SFA 1278S
Set Filter uses SFA 4723SET
H 1 : 264 (mm)
H 2 : 251 (mm)
OD 1 : 131.5 (mm)
OD 2 : 148 (mm)
ID 1 : 63 (mm)
ID 2 : 17 (mm)

CONT : 9
VOL : 0.075

SFA 3189SET Air Filter Set Metal End Cap Element
JOHN DEERE AR80652+AR80653



Primary Filter uses SFA 3189P
Secondary Filter uses SFA 6319S
H 1 : 503 (mm)
H 2 : 493 (mm)
OD 1 : 231 (mm)
OD 2 : 231 (mm)
ID 1 : 132 (mm)
ID 2 : 10 (mm)

CONT : 4
VOL : 0.135

SFA 42117S Air Filter Secondary Metal End Cap Element
HITACHI 4642117



H 1 : 282.5 (mm)
H 2 : 272.5 (mm)
OD 1 : 131 (mm)
OD 2 : 102 (mm)
ID 2 : 16.5 (mm)

CONT : 0
VOL : 0.000

Note : For Hitachi ZX170W-3 Excavator 2017

SFA 4723SET Air Filter Set Metal End Cap Element With Sleeve



CASE 167815A1+167817A1
KOMATSU 3EA-01-18130+3EB-02-19840
HITACHI 4294846+4311871

Primary Filter uses SFA 4723PF
Secondary Filter uses SFA 1278S
H 1 : 264 (mm)
H 2 : 251 (mm)
OD 1 : 131.5 (mm)
OD 2 : 148 (mm)
ID 1 : 63 (mm)
ID 2 : 17 (mm)

CONT : 1
VOL : 0.000

SFA 3776S Air Filter Secondary Metal End Cap Element



INTERNATIONAL HARVESTER 537335 R1
FIAT 79022026
JOHN DEERE AL27159

Primary Filter uses SFA 0760PF
Set Filter uses SFA 0760SET
H 1 : 281 (mm)
H 2 : 279 (mm)
OD 1 : 92.5 (mm)
OD 2 : 75 (mm)
ID 1 : 61 (mm)
ID 2 : 17 (mm)

CONT : 25
VOL : 0.092

SFA 42122P Air Filter Primary Metal End Cap Element
HITACHI 4642122



H 1 : 367 (mm)
H 2 : 341.5 (mm)
OD 1 : 227.5 (mm)
ID 1 : 143 (mm)

CONT : 0
VOL : 0.000

Note : For HITACHI ZX170W-3 2017

SFA 4905P Air Filter Primary Metal End Cap Element
ATLAS COPCO 3216-7082-01



Secondary Filter uses SFA 4589S
Set Filter uses SFA 4905SET
H 1 : 420 (mm)
H 2 : 407 (mm)
OD 1 : 234 (mm)
OD 2 : 276 (mm)
ID 1 : 122.5 (mm)
ID 2 : 15 (mm)

CONT : 1
VOL : 0.041



Product Guide

SFA 5436P Air Filter Primary Soft PU end cap Element

OPEL #1123 84 075
SUNWARD 730403000155
KUBOTA R1401-42270
KUBOTA R1401-42280



Secondary Filter uses SFA 2769S
Set Filter uses SFA 2768SET
H 1 : 312 (mm)
H 2 : 304 (mm)
OD 1 : 127.5 (mm)
OD 2 : 127.5 (mm)
ID 1 : 83 (mm)

CONT : 12
VOL : 0.082

Note : For Flame Retardant version, use SFA 8043P

SFA 6050SET Air Filter Set Metal End Cap Element

KOMATSU 600-181-6050



Primary Filter uses SFA 3113P
Secondary Filter uses SFA 0490S
H 1 : 394 (mm)
H 2 : 381 (mm)
OD 1 : 235 (mm)
OD 2 : 187 (mm)
ID 1 : 120 (mm)
ID 2 : 17 (mm)

CONT : 4
VOL : 0.112

SFA 6099SET Air Filter Set Metal End Cap Element

HITACHI 4206099+4247975



Primary Filter uses SFA 6099P
Secondary Filter uses SFA 7975S
H 1 : 318 (mm)
H 2 : 305 (mm)
OD 1 : 155 (mm)
OD 2 : 155 (mm)
ID 1 : 104 (mm)
ID 2 : 17 (mm)

CONT : 9
VOL : 0.123

SFA 5485S Air Filter Secondary Soft PU end cap Element

YANMAR 119117-12570
CATERPILLAR 1318903
PERKINS 26510343
YANMAR Y119117-12570



Primary Filter uses SFA 8889P
Set Filter uses SFA 8889SET
H 1 : 346 (mm)
H 2 : 340 (mm)
OD 1 : 92 (mm)
OD 2 : 86.5 (mm)
ID 1 : 72.5 (mm)

CONT : 25
VOL : 0.110

Note : Set filter uses SFA 8889 Set(Soft PU+Metal)

SFA 6070SET Air Filter Set Metal End Cap Element

NISSAN 16546-96070
KOMATSU 600-181-1600
KOMATSU 600-182-3100



Primary Filter uses SFA 3130P
Secondary Filter uses SFA 7599S
H 1 : 382 (mm)
H 2 : 349 (mm)
OD 1 : 277 (mm)
OD 2 : 277 (mm)
ID 1 : 165 (mm)
ID 2 : 23 (mm)

CONT : 4
VOL : 0.163

SFA 61281P Air Filter Primary Soft PU+Metal Element

HITACHI 4286128
ISUZU 8-98071421-0
CASE KBH0921



Secondary Filter uses SFA 6130S
Set Filter uses SFA 61281SET
H 1 : 370 (mm)
H 2 : 357 (mm)
OD 1 : 237 (mm)
OD 2 : 237 (mm)
ID 1 : 132 (mm)

CONT : 4
VOL : 0.102

SFA 5623P Air Filter Primary Metal End Cap Element

HITACHI 4285623



Secondary Filter uses SFA 7975S
Set Filter uses SFA 5623SET
H 1 : 327 (mm)
H 2 : 317.5 (mm)
OD 1 : 200 (mm)
OD 2 : 155 (mm)
ID 1 : 104 (mm)
ID 2 : 17 (mm)

CONT : 4
VOL : 0.070

SFA 6098P Air Filter Primary Metal End Cap Element with Flanged Endcap

HITACHI 4206098
HITACHI 4285619
HITACHI 4484532



Secondary Filter uses SFA 8238S
Set Filter uses SFA 6098SET
H 1 : 276 (mm)
H 2 : 263 (mm)
OD 1 : 201.5 (mm)
OD 2 : 252 (mm)
ID 1 : 135.5 (mm)
ID 2 : 22 (mm)

CONT : 1
VOL : 0.021

SFA 61281SET Air Filter Set Soft PU+Metal Element

HITACHI 4286128+4286130



Primary Filter uses SFA 61281P
Secondary Filter uses SFA 6130S
H 1 : 370 (mm)
H 2 : 357 (mm)
OD 1 : 237 (mm)
OD 2 : 237 (mm)
ID 1 : 132 (mm)

CONT : 4
VOL : 0.105

Note : with metal reinforcement

SFA 5623SET Air Filter Set Metal End Cap Element

HITACHI 4285623+4247975



Primary Filter uses SFA 5623P
Secondary Filter uses SFA 7975S
H 1 : 327 (mm)
H 2 : 317.5 (mm)
OD 1 : 200 (mm)
OD 2 : 155 (mm)
ID 1 : 104 (mm)
ID 2 : 17 (mm)

CONT : 4
VOL : 0.074

SFA 6098SET Air Filter Set Metal End Cap Element

HITACHI 4206098+4247974



Primary Filter uses SFA 6098P
Secondary Filter uses SFA 8238S
H 1 : 266 (mm)
H 2 : 237 (mm)
OD 1 : 202 (mm)
OD 2 : 252 (mm)
ID 1 : 135 (mm)
ID 2 : 135 (mm)

CONT : 1
VOL : 0.021

SFA 6128P Air Filter Primary Soft PU end cap Element

HITACHI 4286128
ISUZU 8-98071-421-0



Secondary Filter uses SFA 6130S
Set Filter uses SFA 6128SET
H 1 : 370 (mm)
H 2 : 357 (mm)
OD 1 : 237 (mm)
OD 2 : 237 (mm)
ID 1 : 132 (mm)

CONT : 4
VOL : 0.109

Note : with metal reinforcement version uses SFA 61281P

SFA 5702P Air Filter Primary Element

CATERPILLAR 3I-0374
KOMATSU 600-181-4400
KOMATSU 600-181-4400P
SHANTUI 6128817300



Secondary Filter uses SFA 9372S
Set Filter uses SFA 6244SET
H 1 : 470 (mm)
H 2 : 457 (mm)
OD 1 : 307 (mm)
OD 2 : 377 (mm)
ID 1 : 196 (mm)
ID 2 : 24 (mm)

CONT : 1
VOL : 0.078

SFA 6099P Air Filter Primary Metal End Cap Element

HITACHI 4206099



Secondary Filter uses SFA 7975S
Set Filter uses SFA 6099SET
H 1 : 318 (mm)
H 2 : 305 (mm)
OD 1 : 155 (mm)
OD 2 : 155 (mm)
ID 1 : 154 (mm)
ID 2 : 17 (mm)

CONT : 9
VOL : 0.123

SFA 6128SET Air Filter Set Soft PU end cap Element

HITACHI 4286128+4286130



Primary Filter uses SFA 6128P
Secondary Filter uses SFA 6130S
H 1 : 370 (mm)
H 2 : 357 (mm)
OD 1 : 237 (mm)
OD 2 : 237 (mm)
ID 1 : 130 (mm)

CONT : 4
VOL : 0.105

Note : with metal reinforcement version uses SFA 61281SET



Product Guide

SFA 6130S Air Filter Secondary Soft PU end cap Element
HITACHI 4286130



Primary Filter uses SFA 6128P
Set Filter uses SFA 6128SET
H 1 : 353 (mm)
H 2 : 347 (mm)
OD 1 : 133 (mm)
OD 2 : 125 (mm)
ID 1 : 110 (mm)

CONT : 9
VOL : 0.074

Note : Is a Secondary Air filter for SFA 6128P,SFA 61281P

SFA 7599S Air Filter Secondary Metal End Cap Element
ISUZU 1-14215087-0
NISSAN 16546-96072
HITACHI 4288964



Primary Filter uses SFA 3130P
Set Filter uses SFA 6070SET
H 1 : 368 (mm)
H 2 : 355 (mm)
OD 1 : 162.5 (mm)
OD 2 : 163 (mm)
ID 1 : 134 (mm)
ID 2 : 17 (mm)

CONT : 9
VOL : 0.110

SFA 7869S Air Filter Secondary Soft PU end cap Element
CATERPILLAR 142-1403
ATLAS COPCO 3222-1881-92
HITACHI 4466268



Primary Filter uses SFA 7868P
Set Filter uses SFA 7868SET
H 1 : 500 (mm)
H 2 : 494 (mm)
OD 1 : 179 (mm)
OD 2 : 174 (mm)
ID 1 : 143 (mm)

CONT : 1
VOL : 0.021

Note : Is a Secondary Air filter of SFA 7868P,SFA 7548P

SFA 6319S Air Filter Secondary Metal End Cap Element
HITACHI AR80653
JOHN DEERE AR80653
JOHN DEERE SR80653



Primary Filter uses SFA 3189P
Set Filter uses SFA 3189SET
H 1 : 411 (mm)
H 2 : 398 (mm)
OD 1 : 131 (mm)
OD 2 : 131 (mm)
ID 1 : 102 (mm)
ID 2 : 16.5 (mm)

CONT : 1
VOL : 0.000

SFA 77251P Air Filter Primary Soft PU end cap Element flame retardant media
CLARK 1241080
TOYOTA 17741-U3330-71
KOMATSU 3EC02A541E
LIUGONG 40C0496



H 1 : 356 (mm)
H 2 : 347 (mm)
OD 1 : 163.5 (mm)
OD 2 : 163.5 (mm)
ID 1 : 91 (mm)

CONT : 9
VOL : 0.116

Note : Flame Retardant version of SFA 8889P

SFA 7871P Air Filter Primary Soft PU end cap Element
VOLVO CONSTRUCTION EQUIPMENT 11033998
VOLVO CONSTRUCTION EQUIPMENT 11033998-3



Secondary Filter uses SFA 7875S
H 1 : 580 (mm)
H 2 : 569 (mm)
OD 1 : 313 (mm)
OD 2 : 313 (mm)
ID 1 : 178 (mm)

CONT : 1
VOL : 0.065

SFA 6509S Air Filter Secondary Plastic Element
IHI 074526509
YANMAR 172B06-11520



Primary Filter uses SFA Y541PF
Set Filter uses SFA Y541SET
H 1 : 272 (mm)
OD 1 : 72.4 (mm)
OD 2 : 71 (mm)
ID 1 : 62 (mm)

CONT : 25
VOL : 0.048

SFA 78681PF Air Filter Primary Soft PU+Metal Element With Sleeve
HITACHI 76612497



Secondary Filter uses SFA 7869S
Set Filter uses SFA 78681SETF
H 1 : 521 (mm)
H 2 : 510 (mm)
OD 1 : 313 (mm)
OD 2 : 313 (mm)
ID 1 : 178 (mm)

CONT : 1
VOL : 0.059

SFA 7871SET Air Filter Set Soft PU end cap Element
VOLVO 11033998+11033999
VOLVO 110339983+110033991
TEREX 15272252+15272253
CASE 84069017+84069018



Primary Filter uses SFA 7871P
Secondary Filter uses SFA 7875S
H 1 : 580 (mm)
H 2 : 569 (mm)
OD 1 : 313 (mm)
OD 2 : 313 (mm)
ID 1 : 178 (mm)

CONT : 1
VOL : 0.065

SFA 7313S Air Filter Secondary Metal End Cap Element
ISUZU 1-14215118-0
ISUZU 1-14215127-0
ISUZU 14215-127



Primary Filter uses SFA 1073P
Set Filter uses SFA 1073SET
H 1 : 470 (mm)
H 2 : 457 (mm)
OD 1 : 185 (mm)
OD 2 : 185 (mm)
ID 1 : 157.5 (mm)
ID 2 : 17 (mm)

CONT : 9
VOL : 0.181

SFA 7868PF Air Filter Primary Soft PU end cap Element With Sleeve
VOLVO 11033996
CATERPILLAR 142-1340
ATLAS COPCO 3222-1881-91
FIAT 4466269



Secondary Filter uses SFA 7869S
H 1 : 521 (mm)
H 2 : 510 (mm)
OD 1 : 313 (mm)
OD 2 : 313 (mm)
ID 1 : 178 (mm)

CONT : 1
VOL : 0.057

SFA 7875S Air Filter Secondary Soft PU end cap Element
VOLVO CONSTRUCTION EQUIPMENT 11033999
VOLVO CONSTRUCTION EQUIPMENT 11033999-1



Primary Filter uses SFA 7871P
H 1 : 563 (mm)
H 2 : 557 (mm)
OD 1 : 179 (mm)
OD 2 : 174 (mm)
ID 1 : 148 (mm)

CONT : 6
VOL : 0.136

SFA 7315S Air Filter Secondary Metal End Cap Element
ISUZU 1-14215061-0
ISUZU 1-14215078-0
ISUZU 1-14215078-1



Primary Filter uses SFA 1080P
Set Filter uses SFA 9025SET
H 1 : 318 (mm)
H 2 : 305 (mm)
OD 1 : 145 (mm)
OD 2 : 145 (mm)
ID 1 : 116 (mm)
ID 2 : 23 (mm)

CONT : 9
VOL : 0.080

SFA 7868SETF Air Filter Set Soft PU end cap Element With Sleeve
HITACHI 76612497+4466268
SANY B22210000641+B22210000640



H 1 : 521 (mm)
H 2 : 510 (mm)
OD 1 : 313 (mm)
OD 2 : 313 (mm)
ID 1 : 178 (mm)

CONT : 1
VOL : 0.059

SFA 7975S Air Filter Secondary Metal End Cap Element
HITACHI 4247975

















Primary Filter uses SFA 5623P
Set Filter uses SFA 5623SET
H 1 : 295 (mm)
H 2 : 285 (mm)
OD 1 : 100.5 (mm)
OD 2 : 100.5 (mm)
ID 1 : 81 (mm)
ID 2 : 17 (mm)

CONT : 25
VOL : 0.097

Note : Is a Secondary Air filter for SFA 6099P,SFA 5623P



Product Guide

<p>SFA 8172 Air Filter Metal framed Element</p> <p>HITACHI 4206637 HITACHI 4S01130 JOHN DEERE AT116077</p>  <p>H 1 : 56.6 (mm) Length 1 : 435 (mm) Width 1 : 215 (mm)</p> <p>CONT : 1 VOL : 0.009</p>	<p>SFA 8863P Air Filter Primary Soft PU end cap Element</p> <p>MANITOU 948863P</p>  <p>Secondary Filter uses SFA 8863S Set Filter uses SFA 8863SET H 1 : 343 (mm) H 2 : 318 (mm) OD 1 : 197 (mm) OD 2 : 197 (mm) ID 1 : 108 (mm)</p> <p>CONT : 9 VOL : 0.159</p>	<p>SFA 9025SET Air Filter Set Metal End Cap Element</p> <p>NISSAN 16546-Z9025 NISSAN 16546-Z9027 CATERPILLAR 7Y-0404+7Y-0403</p>  <p>Primary Filter uses SFA 1080P Secondary Filter uses SFA 7315S H 1 : 343 (mm) H 2 : 330 (mm) OD 1 : 232 (mm) OD 2 : 232 (mm) ID 1 : 147 (mm) ID 2 : 23 (mm)</p> <p>CONT : 4 VOL : 0.094</p>
<p>SFA 8238S Air Filter Secondary Metal End Cap Element</p> <p>HITACHI 4209588 HITACHI 4247974</p>  <p>Primary Filter uses SFA 6098P Set Filter uses SFA 6098SET H 1 : 250 (mm) H 2 : 237 (mm) OD 1 : 133.5 (mm) OD 2 : 133.5 (mm) ID 1 : 105 (mm) ID 2 : 17 (mm)</p> <p>CONT : 10 VOL : 0.076</p>	<p>SFA 8863S Air Filter Secondary Soft PU end cap Element</p> <p>MANITOU 948863S</p>  <p>Primary Filter uses SFA 8863P Set Filter uses SFA 8863SET H 1 : 324 (mm) H 2 : 322 (mm) OD 1 : 119.5 (mm) OD 2 : 107.5 (mm) ID 1 : 77.5 (mm)</p> <p>CONT : 9 VOL : 0.060</p>	<p>SFA 9372S Air Filter Secondary Metal End Cap Element</p> <p>NISSAN 16546-97005 CATERPILLAR 3I-0125 HITACHI 4177212</p>  <p>Primary Filter uses SFA 5702P Set Filter uses SFA 6244SET H 1 : 449 (mm) OD 1 : 215 (mm) OD 2 : 185 (mm) ID 1 : 157.5 (mm) ID 2 : 17 (mm)</p> <p>CONT : 4 VOL : 0.106</p> <p>Note : Is a Secondary Air filter for SFA 5702P,SFA 1002P</p>
<p>SFA 8408S Air Filter Secondary Metal End Cap Element</p> <p>CATERPILLAR 1N-4864 CUMMINS 3013213 CATERPILLAR 3I-0215</p>  <p>Primary Filter uses SFA 1042P Set Filter uses SFA 1042SET H 1 : 572 (mm) H 2 : 559 (mm) OD 1 : 260 (mm) OD 2 : 260 (mm) ID 1 : 231.5 (mm) ID 2 : 23 (mm)</p> <p>CONT : 1 VOL : 0.049</p>	<p>SFA 88891P Air Filter Primary Soft PU+Metal Element</p> <p>CATERPILLAR 131-8902 LIUGONG 40C0496</p>  <p>Secondary Filter uses SFA 5485S Set Filter uses SFA 88891SET H 1 : 356 (mm) H 2 : 347 (mm) OD 1 : 163.5 (mm) OD 2 : 163.5 (mm) ID 1 : 91 (mm)</p> <p>CONT : 9 VOL : 0.108</p> <p>Note : with reinforcement metal</p>	<p>SFA 9373S Air Filter Secondary Metal End Cap Element</p> <p>ISUZU 1-14215034-0 ISUZU 1-14215036-0 NISSAN 16546-96014</p>  <p>Primary Filter uses SFA 1046P Set Filter uses SFA 3800SET H 1 : 406 (mm) OD 1 : 192 (mm) OD 2 : 162.5 (mm) ID 1 : 134 (mm) ID 2 : 17 (mm)</p> <p>CONT : 4 VOL : 0.077</p> <p>Note : Is a Secondary Air filter for SFA 1046P,SFA 2523P</p>
<p>SFA 8600SET Air Filter Set Metal End Cap Element</p> <p>KOMATSU 600-181-8600 KOMATSU 600-182-2700 KOMATSU 600-182-3200</p>  <p>Primary Filter uses SFA 2530P Secondary Filter uses SFA 4046S H 1 : 457 (mm) H 2 : 432 (mm) OD 1 : 232 (mm) OD 2 : 145 (mm) ID 1 : 147 (mm) ID 2 : 23 (mm)</p> <p>CONT : 4 VOL : 0.134</p>	<p>SFA 88891SET Air Filter Set Soft PU+Metal Element</p> <p>CATERPILLAR 131-8902+131-8903 LIUGONG 40C0496</p>  <p>Primary Filter uses SFA 88891P Secondary Filter uses SFA 5485S H 1 : 356 (mm) H 2 : 347 (mm) OD 1 : 163.5 (mm) OD 2 : 163.5 (mm) ID 1 : 91 (mm)</p> <p>CONT : 9 VOL : 0.116</p> <p>Note : with reinforcement metal</p>	<p>SFA 9591S Air Filter Secondary Metal End Cap Element</p> <p>ISUZU 1-14215089-0 NISSAN 16546-96065 KOBELCO 2446U250S-2</p>  <p>Primary Filter uses SFA 1082P Set Filter uses SFA 6063SET H 1 : 496 (mm) H 2 : 483 (mm) OD 1 : 162 (mm) OD 2 : 162 (mm) ID 1 : 134 (mm) ID 2 : 17 (mm)</p> <p>CONT : 9 VOL : 0.149</p>
<p>SFA 8813S Air Filter Secondary Soft PU end cap Element</p> <p>HITACHI 4459548 KOMATSU 600-185-4220 JOHN DEERE F434395 CASE IH275810A1</p>  <p>Primary Filter uses SFA 2363P Set Filter uses SFA 2363SET H 1 : 502.5 (mm) H 2 : 497 (mm) OD 1 : 150 (mm) OD 2 : 141.5 (mm) ID 1 : 109 (mm)</p> <p>CONT : 9 VOL : 0.133</p> <p>Note : Is a long life version of SFA 7414S</p>	<p>SFA 8889P Air Filter Primary Soft PU end cap Element</p> <p>YANMAR 119117-12560 CATERPILLAR 131-8902 PERKINS 26510342 LIUGONG 40C0496 HITACHI 4486002</p>  <p>Secondary Filter uses SFA 5485S Set Filter uses SFA 8889SET H 1 : 356 (mm) H 2 : 347 (mm) OD 1 : 163.5 (mm) OD 2 : 163.5 (mm) ID 1 : 91 (mm)</p> <p>CONT : 9 VOL : 0.120</p>	<p>SFA Y541PF Air Filter Primary Soft PU end cap Element</p> <p>KATO 119-727001000 KATO 119-72701001 YANMAR 172B06-11510 YANMAR 1E6B35-04020 HITACHI YD00001541</p>  <p>Secondary Filter uses SFA 6509S Set Filter uses SFA Y541SET H 1 : 301.5 (mm) H 2 : 294 (mm) OD 1 : 140 (mm) OD 2 : 140 (mm) ID 1 : 72 (mm)</p> <p>CONT : 4 VOL : 0.036</p>



To order, please call:
+1 8448 BE SURE; +1 (925) 566-8863

FOR REFERENCE ONLY - REPRESENTATIVE PICTURE ONLY



Email :
order@surefilter.us



Product Guide

<p>SFA Y541SET Air Filter Set Soft PU end cap Element</p> <p>IHI 074526508+074526509</p>  <p>Primary Filter uses SFA Y541PF Secondary Filter uses SFA 6509S H 1 : 301.5 (mm) H 2 : 294 (mm) OD 1 : 140 (mm) OD 2 : 140 (mm) ID 1 : 62 (mm)</p> <p>CONT : 4 VOL : 0.032</p>	<p>SFC 32683 Cabin Air Filter Plastic framed Element</p> <p>HITACHI YA00032683</p>  <p>H 1 : 77 (mm) Length 1 : 320 (mm) Width 1 : 216 (mm)</p> <p>CONT : 20 VOL : 0.146</p> <p>Note : with foam</p>	<p>SFF 0009 Fuel Filter Spin-On</p> <p>NISSAN 16403-89TA1 NISSAN 16403-J5500 HITACHI 4285643</p>  <p>H 1 : 87 (mm) OD 1 : 80 (mm) Thread Size : 3/4-16 UNF-2B Gasket Type : Round</p> <p>CONT : 50 VOL : 0.042</p>
<p>SFC 00684 Cabin Air Filter Plastic framed Element</p> <p>HITACHI 4441139 HITACHI 4S00684 JOHN DEERE 4S00684</p>  <p>H 1 : 10 (mm) Length 1 : 287.5 (mm) Width 1 : 178.5 (mm)</p> <p>CONT : 20 VOL : 0.021</p> <p>Note :</p>	<p>SFC 32689 Cabin Air Filter Plastic framed Element</p> <p>HITACHI 4632689 HITACHI 4S00686</p>  <p>H 1 : 75 (mm) Length 1 : 320 (mm) Width 1 : 216 (mm)</p> <p>CONT : 20 VOL : 0.152</p> <p>Note : For Outside application</p>	<p>SFF 0027 Fuel Filter Metal End Cap Element</p> <p>ISUZU 1-13240008-0 ISUZU 1-87810027-0 ISUZU 1-87810027-1</p>  <p>H 1 : 138.5 (mm) H 2 : 137.5 (mm) OD 1 : 92 (mm) OD 2 : 92 (mm) ID 1 : 14.5 (mm) ID 2 : 14.5 (mm)</p> <p>CONT : 50 VOL : 0.074</p>
<p>SFC 01490 Cabin Air Filter Plastic framed Element</p> <p>HITACHI YA00001490</p>  <p>H 1 : 42 (mm) Length 1 : 261 (mm) Length 2 : 219 (mm) Width 1 : 243 (mm) Width 2 : 237 (mm)</p> <p>CONT : 20 VOL : 0.091</p>	<p>SFC 43580 Cabin Air Filter Plastic framed Element</p> <p>HITACHI 4643580 HITACHI 4S00685</p>  <p>H 1 : 55 (mm) H 2 : 45 (mm) Length 1 : 281 (mm) Width 1 : 161 (mm)</p> <p>CONT : 20 VOL : 0.064</p> <p>Note : For Inside application</p>	<p>SFF 0047 Fuel Filter Spin-On Synthetic Media</p> <p>DETROIT DIESEL 23518529 DETROIT DIESEL 23530644 HITACHI E12980183-1</p>  <p>H 1 : 228 (mm) OD 1 : 118 (mm) Thread Size : 1 1/6-16 UNG-2B Gasket Type : Square</p> <p>CONT : 6 VOL : 0.028</p> <p>Note :</p>
<p>SFC 13531 Cabin Air Filter Plastic framed Element</p> <p>KOMATSU 17M-911-3530 HITACHI 4234793 KOMATSU 569-076-1190 FIAT 71498266 KUBOTA T0270-67060</p>  <p>H 1 : 51 (mm) Length 1 : 220 (mm) Width 1 : 163 (mm)</p> <p>CONT : 20 VOL : 0.049</p>	<p>SFC 50249 Cabin Air Filter Plastic framed Element</p> <p>HITACHI 4350249 HITACHI 4S00640</p>  <p>H 1 : 71 (mm) Length 1 : 346 (mm) Width 1 : 254 (mm)</p> <p>CONT : 10 VOL : 0.077</p>	<p>SFF 0052 Fuel Filter Spin-On High Efficiency</p> <p>J.C.BAMFORD 02/800001 ISUZU 1-13240009-0 ISUZU 1-13240041-0</p>  <p>H 1 : 125 (mm) OD 1 : 90 (mm) Thread Size : 3/4-16 UNF-2B Gasket Type : Round</p> <p>CONT : 25 VOL : 0.036</p>
<p>SFC 30763 Cabin Air Filter Metal framed Element</p> <p>VOLVO 12583881 HITACHI 12630763 DEUTZ 70257109 FIAT 70257109 EUCLID E12583881</p>  <p>H 1 : 55.6 (mm) Length 1 : 406 (mm) Width 1 : 305 (mm)</p> <p>CONT : 2 VOL : 0.017</p>	<p>SFC 58237 Cabin Air Filter Plastic framed Element with pull tabs</p> <p>CATERPILLAR 245-8237 HITACHI 263G6-73191 TCM 263G6-73191</p>  <p>H 1 : 23 (mm) Length 1 : 245 (mm) Width 1 : 203 (mm)</p> <p>CONT : 20 VOL : 0.034</p>	<p>SFF 0057 Fuel Filter Spin-On High Efficiency</p> <p>HITACHI 4S00203</p>  <p>H 1 : 89 (mm) OD 1 : 76 (mm) Thread Size : 3/4-16 UNF-2B Gasket Type : Square</p> <p>CONT : 50 VOL : 0.040</p>



Product Guide

SFF 0105D Fuel Filter Spin-On

MITSUBISHI 32540-20300
MITSUBISHI 32562-20300
HITACHI 4085912



H 1 : 175 (mm)
OD 1 : 93 (mm)
Thread Size : 1-14 UNS-2B
Thread Nut Size : M8X1.25
Gasket Type : Square

CONT : 12
VOL : 0.028

SFF 0522 Fuel Filter Spin-On

ALLIS CHALMERS 1919100
MANITOU 49660
CASE K915319



H 1 : 71.5 (mm)
OD 1 : 85 (mm)
OD 2 : 88.2 (mm)
ID 1 : 39 (mm)
ID 2 : 15 (mm)

CONT : 50
VOL : 0.038

SFF 105N Fuel Filter Spin-On

CUMMINS 154709
CUMMINS 3315844



H 1 : 136 (mm)
OD 1 : 93 (mm)
Thread Size : 1-14 UNS-2B

CONT : 12
VOL : 0.022

Note : Is a short version of SFF 0213

SFF 0167 Fuel Filter Spin-On

VW GROUP 061 198 552
NISSAN 16403-76200
VOLVO 236628
VOLVO 236628/4



H 1 : 71 (mm)
OD 1 : 84 (mm)
OD 2 : 86.5 (mm)
ID 1 : 19.5 (mm)
ID 2 : 19.5 (mm)

CONT : 50
VOL : 0.038

SFF 0723 Fuel Filter Spin-On

VOLVO 241672
VOLVO 243004
MASSEY-FERGUSON 2871513M1



H 1 : 123 (mm)
OD 1 : 76 (mm)
Thread Size : M16X1.5-6H
Gasket Type : Square

CONT : 50
VOL : 0.048

Note : With Center Tube

SFF 1605 Fuel Filter Spin-On

IVECO 1901605
FIAT 1909103
FIAT 1909119



H 1 : 185 (mm)
OD 1 : 108 (mm)
Thread Size : 3/4-16 UNF-2B
Gasket Type : Square

CONT : 6
VOL : 0.019

SFF 0207 Fuel Filter Metal End Cap Element

ISUZU 1-87810207-0
ISUZU 1-87810207-1
ISUZU 1-87810207-2



H 1 : 166 (mm)
H 2 : 160 (mm)
OD 1 : 101 (mm)
OD 2 : 101 (mm)
ID 1 : 14.5 (mm)
ID 2 : 14.5 (mm)

CONT : 50
VOL : 0.107

SFF 1010 Fuel Filter Metal End Cap Element

ISUZU 13240-029
NISSAN 16403-90026
NISSAN 16444-90000



H 1 : 105 (mm)
OD 1 : 74 (mm)
OD 2 : 74 (mm)
ID 1 : 16 (mm)
ID 2 : 16 (mm)

CONT : 50
VOL : 0.039

SFF 1723 Fuel Filter Spin-On

LOMBARDINI 276-2175-046
VOLVO 7243004-4



H 1 : 122 (mm)
OD 1 : 76 (mm)
Thread Size : M16X1.5-6H
Gasket Type : Square

CONT : 50
VOL : 0.050

Note : HIGH PERFORMANCE VERSION USES SFF 5167

SFF 0220 Fuel Filter Metal End Cap Element

ISUZU 8-94437022-0



H 1 : 35.6 (mm)
H 2 : 33 (mm)
OD 1 : 41 (mm)
OD 2 : 41 (mm)
ID 1 : 24.5 (mm)
ID 2 : 24.5 (mm)

CONT : 100
VOL : 0.011

SFF 1040 Fuel Filter Metal End Cap Element

HINO 23401-1040
HINO 23401-1050
HINO 6052-2008-00



H 1 : 102 (mm)
H 2 : 100 (mm)
OD 1 : 71 (mm)
OD 2 : 71 (mm)
ID 1 : 15 (mm)
ID 2 : 15 (mm)

CONT : 50
VOL : 0.059

SFF 2001 Fuel Filter Spin-On

PERKINS 130366020
NISSAN 16403-09W00
NISSAN 16403-27000



H 1 : 80 (mm)
OD 1 : 80 (mm)
Thread Size : 3/4-16 UNF-2B

CONT : 50
VOL : 0.035

SFF 0404 Fuel Filter Secondary Metal End Cap Element

MERCEDES-BENZ 000 477 40 15
MERCEDES-BENZ 000 477 45 15



H 1 : 145 (mm)
H 2 : 138 (mm)
OD 1 : 83 (mm)
OD 2 : 83 (mm)
ID 1 : 14 (mm)
ID 2 : 14 (mm)

CONT : 50
VOL : 0.113

SFF 1045 Fuel Filter Metal End Cap Element

YANMAR 104500-55710
MASSEY-FERGUSON 3283343-M1
HITACHI 4294842
ISUZU 5-87810269-0
JOHN DEERE CH15553



H 1 : 69 (mm)
H 2 : 66.5 (mm)
OD 1 : 35 (mm)
OD 2 : 35 (mm)
ID 1 : 11 (mm)
ADB: YES

CONT : 100
VOL : 0.015

SFF 2390 Fuel Filter Metal End Cap Element

HINO 23401-1020
HINO 23401-1021
HINO 23401-1080















H 1 : 109 (mm)
H 2 : 104 (mm)
OD 1 : 103 (mm)
OD 2 : 104 (mm)
ID 1 : 49 (mm)
ID 2 : 15 (mm)

CONT : 50
VOL : 0.077



Product Guide

<p>SFF 2564</p>  <p>CONT : 12 VOL : 0.018</p>	<p>Fuel Filter Spin-On</p> <p>ISUZU 1-13200688-0 ISUZU 1-13240074-0 ISUZU 1-13240079-1 HITACHI 4206080 VM 4531026</p> <p>H 1 : 125 (mm) OD 1 : 90 (mm) Thread Size : 3/4-16 UNF-2B Gasket Type : Square</p>	<p>SFF 3425</p>  <p>CONT : 50 VOL : 0.049</p>	<p>Fuel Filter Spin-On</p> <p>SUZUKI 15410-78E00 SUZUKI 15411-78E00</p> <p>H 1 : 120 (mm) OD 1 : 80 (mm) Thread Size : M20X1.5-6H Thread Nut Size : M22X1.5-6H Gasket Type : Round</p>	<p>SFF 4234</p>  <p>CONT : 6 VOL : 0.032</p>	<p>Fuel Filter Spin-On High Efficiency</p> <p>CUMMINS 4964234</p> <p>H 1 : 262 (mm) OD 1 : 118 (mm) Thread Size : 2 1/4-12 UNF-2B</p>
<p>SFF 2631</p>  <p>CONT : 12 VOL : 0.028</p>	<p>Fuel Filter Spin-On With Nut</p> <p>HITACHI 4192631</p> <p>H 1 : 183 (mm) H 2 : 175 (mm) OD 1 : 93 (mm) Thread Size : 1-14 UNS-2B Gasket Type : Square</p>	<p>SFF 3486</p>  <p>CONT : 12 VOL : 0.042</p>	<p>Fuel Filter Spin-On With Nut</p> <p>ISUZU 8-98312918-0 ISUZU 8982394641 SUMITOMO MMH80990 HITACHI YA00033486</p> <p>H 1 : 200 (mm) OD 1 : 108 (mm) Thread Size : M82X1.5-6H Gasket Type : Square</p>	<p>SFF 5036</p>  <p>CONT : 10 VOL : 0.044</p>	<p>Fuel Filter Spin-On</p> <p>GENERAL MOTORS 23518528 GENERAL MOTORS 25011024</p> <p>H 1 : 228 (mm) OD 1 : 118 (mm) Thread Size : 1 1/4-12 UNF-2B Gasket Type : Square</p>
<p>SFF 3160</p>  <p>CONT : 50 VOL : 0.018</p>	<p>Fuel Filter Metal End Cap Element</p> <p>YANMAR 129100-55650 KUBOTA 15521-43160 KUBOTA 607</p> <p>H 1 : 89.5 (mm) OD 1 : 50 (mm) OD 2 : 50 (mm) ID 1 : 20 (mm)</p>	<p>SFF 3560</p>  <p>CONT : 50 VOL : 0.008</p>	<p>Fuel Filter Metal End Cap Element</p> <p>YANMAR 119810-55650 YANMAR 124550-55700 KUBOTA 16271-43560</p> <p>H 1 : 87.5 (mm) H 2 : 85 (mm) OD 1 : 35 (mm) OD 2 : 35 (mm) ID 1 : 11 (mm)</p>	<p>SFF 5052</p>  <p>CONT : 25 VOL : 0.025</p>	<p>Fuel Filter Secondary Spin-On High Efficiency</p> <p>J.C.BAMFORD 02/910155 CUMMINS 3903640 CUMMINS 3931063</p> <p>H 1 : 115 (mm) OD 1 : 76 (mm) Thread Size : M16X1.5-6H Gasket Type : Square</p>
<p>SFF 3291</p>  <p>CONT : 25 VOL : 0.038</p>	<p>Fuel Filter Spin-On</p> <p>KHD(KLOCKNER-HUMBOLT-DEUTZ) 1174482 J.C.BAMFORD 32/912001</p> <p>H 1 : 163 (mm) OD 1 : 81.5 (mm) Thread Size : M16X1.5-6H Thread Nut Size : M8X1.25 Gasket Type : Square</p>	<p>SFF 3563</p>  <p>CONT : 100 VOL : 0.011</p>	<p>Fuel Filter Metal End Cap Element</p> <p>KUBOTA 15231-4356-0 KUBOTA 15231-4356-3 MITSUBISHI MM 404889</p> <p>H 1 : 85 (mm) OD 1 : 29 (mm) OD 2 : 29 (mm) ID 1 : 13 (mm) ID 2 : 13 (mm)</p>	<p>SFF 5064</p>  <p>CONT : 25 VOL : 0.054</p>	<p>Fuel Filter Metal End Cap Element</p> <p>FIAT 1902096 IVECO 1902096 IVECO 1902096022 FIAT 1909107 NEW HOLLAND (CNH) 1909107</p> <p>H 1 : 187 (mm) H 2 : 177 (mm) OD 1 : 91 (mm) OD 2 : 91 (mm) ID 1 : 26.3 (mm) ID 2 : 12.8 (mm)</p>
<p>SFF 3390</p>  <p>CONT : 50 VOL : 0.034</p>	<p>Fuel Filter Spin-On</p> <p>KUBOTA 15221-43080 KUBOTA 15221-43081 KUBOTA 15221-43170</p> <p>H 1 : 75 (mm) OD 1 : 80 (mm) Thread Size : M20X1.5-6H Gasket Type : Round</p>	<p>SFF 3811</p>  <p>CONT : 50 VOL : 0.063</p>	<p>Fuel Filter Primary Metal End Cap Element</p> <p>MERCEDES-BENZ 000 477 31 15</p> <p>H 1 : 145 (mm) H 2 : 130 (mm) OD 1 : 84.5 (mm) OD 2 : 84.5 (mm) ID 1 : 13 (mm) ID 2 : 13 (mm)</p>	<p>SFF 6030</p>  <p>CONT : 12 VOL : 0.022</p>	<p>Fuel Filter Spin-On High Efficiency</p> <p>KUBOTA 1J301-43170 MITSUBISHI 32562-60300</p> <p>H 1 : 145 (mm) OD 1 : 93.4 (mm) Thread Size : 1-14 UNS-2B</p>



To order, please call:
+1 8448 BE SURE; +1 (925) 566-8863















FOR REFERENCE ONLY - REPRESENTATIVE PICTURE ONLY



Email :
order@surefilter.us



Product Guide

<p>SFF 6130</p>  <p>CONT : 36 VOL : 0.033</p>	<p>Fuel Filter Spin-On</p> <p>HITACHI 4206130 ISUZU 8-94453738-1 ISUZU 8-94453738-2</p> <p>H 1 : 82 (mm) OD 1 : 90 (mm) Thread Size : 3/4-16 UNF-2B Gasket Type : Round</p>	<p>SFF 7240</p>  <p>CONT : 25 VOL : 0.033</p>	<p>Fuel Filter Spin-On</p> <p>IVECO 190 4640 IVECO 190 7640 IVECO 193 0953</p> <p>H 1 : 145 (mm) OD 1 : 76 (mm) Thread Size : M16X1.5-6H</p>	<p>SFF 9920E</p>  <p>CONT : 12 VOL : 0.393</p>	<p>Fuel Filter Main Eco Element High Efficiency</p> <p>HITACHI 4719920 ISUZU 8981527370</p> <p>H 1 : 204.5 (mm) OD 1 : 94 (mm) OD 2 : 94 (mm) ID 1 : 26 (mm) ID 2 : 44 (mm)</p> <p>Note : dual element/media (4 micron)</p>
<p>SFF 6280</p>  <p>CONT : 12 VOL : 0.028</p>	<p>Fuel Filter Spin-On</p> <p>HITACHI 4326739 NISSAN AY500-MT502 CASE-IH CNH KHH10030 SUMITOMO KHH10030</p> <p>H 1 : 172 (mm) OD 1 : 93.2 (mm) Thread Size : M24X1.5-6H Gasket Type : Square</p>	<p>SFF 9013</p>  <p>CONT : 12 VOL : 0.024</p>	<p>Fuel Filter Spin-On with head body</p> <p>NISSAN 16403-99013 NISSAN 16403-NY001</p> <p>H 1 : 145 (mm) OD 1 : 93 (mm) Thread Size : 1-14 UNS-2B Gasket Type : Square</p>	<p>SFF 9921E</p>  <p>CONT : 12 VOL : 0.022</p>	<p>Fuel Filter Main Eco Element High Efficiency</p> <p>HITACHI 4719921 ISUZU 8981527380</p> <p>H 1 : 141.5 (mm) H 2 : 131 (mm) OD 1 : 94 (mm) OD 2 : 94 (mm) ID 1 : 26 (mm)</p> <p>Note : dual element/media</p>
<p>SFF 6385E</p>  <p>CONT : 12 VOL : 0.024</p> <p>Note : 7 micron</p>	<p>Fuel Filter Primary Eco Element High Efficiency</p> <p>HITACHI 4649267 HITACHI 4676385 SUMITOMO KHH12030 KOBELCO YN21P01036R100</p> <p>H 1 : 167 (mm) H 2 : 155 (mm) OD 1 : 94 (mm) OD 2 : 94 (mm) ID 1 : 26 (mm)</p>	<p>SFF 9016</p>  <p>CONT : 25 VOL : 0.052</p>	<p>Fuel Filter Spin-On</p> <p>HITACHI YA00029016</p> <p>H 1 : 172 (mm) OD 1 : 93 (mm) Thread Size : 1 1/8-16 UNF-2B Gasket Type : Round</p>	<p>SFF 99812E</p>  <p>CONT : 12 VOL : 0.039</p>	<p>Fuel Filter Main Eco Element High Efficiency</p> <p>HITACHI 4679981</p> <p>H 1 : 204.5 (mm) OD 1 : 94 (mm) OD 2 : 94 (mm) ID 1 : 26 (mm) ID 2 : 44 (mm)</p> <p>Note : 4 micron</p>
<p>SFF 6915</p>  <p>CONT : 12 VOL : 0.028</p>	<p>Fuel Filter Primary Spin-On</p> <p>GENERAL MOTORS 25014274 GENERAL MOTORS 6438839</p> <p>Secondary Filter uses SFF 6916</p> <p>H 1 : 203 (mm) OD 1 : 93 (mm) Thread Size : 1-12 UNF-2B Gasket Type : Square</p>	<p>SFF 9128</p>  <p>CONT : 50 VOL : 0.073</p>	<p>Fuel Filter Metal End Cap Element</p> <p>NISSAN 16444-90027 NISSAN 16444-99127 NISSAN 16444-99128</p> <p>H 1 : 141 (mm) H 2 : 134 (mm) OD 1 : 91.5 (mm) OD 2 : 91.5 (mm) ID 1 : 14.5 (mm) ID 2 : 14.5 (mm)</p>	<p>SFF 9991E</p>  <p>CONT : 12 VOL : 0.038</p>	<p>Fuel Filter Eco Element High Efficiency</p> <p>MERCEDES-BENZ 541 090 00 51 MERCEDES-BENZ 541 090 01 51 MERCEDES-BENZ 541 092 03 05</p> <p>H 1 : 204 (mm) H 2 : 174.5 (mm) OD 1 : 105 (mm) OD 2 : 95 (mm) ID 1 : 45 (mm) ID 2 : 13 (mm)</p>
<p>SFF 6916</p>  <p>CONT : 12 VOL : 0.023</p>	<p>Fuel Filter Secondary Spin-On</p> <p>GENERAL MOTORS 25010778 GENERAL MOTORS 6438840</p> <p>Primary Filter uses SFF 6915</p> <p>H 1 : 172 (mm) OD 1 : 93 (mm) Thread Size : 13/16-12 UNF-2B</p>	<p>SFF 9267E</p>  <p>CONT : 12 VOL : 0.020</p> <p>Note : SFF 9267E media 14 micron, to upgrade use SFF 6385E media 7 micron</p>	<p>Fuel Filter Primary Eco Element 14 micron</p> <p>HITACHI 4649267 SUMITOMO KHH10590 KOBELCO YN21P01036R100</p> <p>H 1 : 167 (mm) H 2 : 155 (mm) OD 1 : 94 (mm) OD 2 : 94 (mm) ID 1 : 26 (mm)</p>	<p>SFF R100</p>  <p>CONT : 50 VOL : 0.036</p>	<p>Fuel Filter Metal End Cap Element</p> <p>KOBELCO LS02P01012R100 KOBELCO LS02P01012S002 HITACHI YA00002973</p> <p>H 1 : 144.5 (mm) H 2 : 106.5 (mm) OD 1 : 60 (mm) OD 2 : 60 (mm) ID 1 : 16 (mm)</p>



To order, please call:
+1 8448 BE SURE; +1 (925) 566-8863

FOR REFERENCE ONLY - REPRESENTATIVE PICTURE ONLY



Email :
order@surefilter.us



Product Guide

<p>SFF Y025E</p>	<p>Fuel Filter Eco Element High Efficiency NISSAN 16444-NY025 HITACHI 4642641</p> <p>H 1 : 142 (mm) H 2 : 130 (mm) OD 1 : 94 (mm) OD 2 : 94 (mm) ID 1 : 26 (mm)</p> <p>CONT : 12 VOL : 0.020</p> <p>Note : SFF 1897E (difference in outer packing B)</p>	<p>SFH 0403</p>	<p>Hydraulic Oil Filter Metal End Cap Element HITACHI 4225846 KOBELCO H 403</p>  <p>H 1 : 358 (mm) H 2 : 344 (mm) OD 1 : 90 (mm) OD 2 : 90 (mm) ID 1 : 47 (mm) ID 2 : 47 (mm)</p> <p>CONT : 20 VOL : 0.082</p>	<p>SFH 0987</p>	<p>Hydraulic Oil Filter Wire Mesh supported Element HITACHI 4190987</p> <p>H 1 : 128 (mm) H 2 : 89 (mm) OD 1 : 150 (mm) OD 2 : 150 (mm) ID 1 : 73.4 (mm)</p> <p>CONT : 9 VOL : 0.039</p>
<p>SFH 0010</p>	<p>Hydraulic Oil Filter Spin-On KUBOTA 68131-6213-0 MITSUBISHI 91004-10021 YSK IHI-075511900 MITSUBISHI LPF 010</p>  <p>H 1 : 141 (mm) OD 1 : 93 (mm) Thread Size : 1 1/8-16 UNF-2B</p> <p>CONT : 25 VOL : 0.046</p> <p>Note : SFH 9615 (Grip body Difference)</p>	<p>SFH 0409</p>	<p>Hydraulic Oil Filter Metal End Cap Element DAEWOO 2474-1001 HITACHI 4159320 KOBELCO H 409</p>  <p>H 1 : 123.6 (mm) H 2 : 113 (mm) OD 1 : 73 (mm) OD 2 : 73 (mm) ID 1 : 34 (mm) ID 2 : 34 (mm)</p> <p>CONT : 50 VOL : 0.063</p>	<p>SFH 1334</p>	<p>Hydraulic Oil Filter Metal End Cap Element CATERPILLAR 094-4412 HITACHI 4219713</p>  <p>H 1 : 455 (mm) H 2 : 450 (mm) OD 1 : 150 (mm) OD 2 : 150 (mm) ID 1 : 110 (mm) ID 2 : 110 (mm)</p> <p>CONT : 6 VOL : 0.080</p> <p>Note : With outer packing 1 pc</p>
<p>SFH 0084</p>	<p>Hydraulic Oil Filter Element With Microfiber media VOLVO 11707544 J.C.BAMFORD 32/917701 J.C.BAMFORD 6900/0084</p>  <p>H 1 : 112 (mm) H 2 : 108 (mm) OD 1 : 51 (mm) OD 2 : 51 (mm) ID 1 : 23 (mm)</p> <p>CONT : 50 VOL : 0.028</p>	<p>SFH 0416</p>	<p>Hydraulic Oil Filter Metal End Cap Element With Microfiber media PALL HC8904FKS16H</p>  <p>H 1 : 413 (mm) H 2 : 400 (mm) OD 1 : 104 (mm) OD 2 : 97 (mm) ID 1 : 62 (mm)</p> <p>CONT : 12 VOL : 0.039</p>	<p>SFH 1430</p>	<p>Hydraulic Oil Filter Metal End Cap Element KOMATSU 07063-01210 KOMATSU 205-60-51430</p>  <p>H 1 : 450 (mm) OD 1 : 150 (mm) OD 2 : 150 (mm) ID 1 : 110 (mm) ID 2 : 110 (mm)</p> <p>CONT : 10 VOL : 0.134</p> <p>Note : Without gasket</p>
<p>SFH 0147</p>	<p>Hydraulic Oil Filter Spin-On CLARK 234099 CATERPILLAR 311980 J.C.BAMFORD 4110147 FIAT 906041007</p>  <p>H 1 : 140 (mm) OD 1 : 93.5 (mm) Thread Size : 2-16 UNF-2B Gasket Type : Square</p> <p>CONT : 12 VOL : 0.022</p>	<p>SFH 0525</p>	<p>Hydraulic Oil Filter Spin-On Cellulose media HITACHI 4630525</p>  <p>H 1 : 168 (mm) OD 1 : 82.5 (mm) Thread Size : M68X2-6H</p> <p>CONT : 12 VOL : 0.025</p>	<p>SFH 2011</p>	<p>Hydraulic Oil Filter Metal End Cap Element HYUNDAI 263E7-52011</p>  <p>H 1 : 183 (mm) OD 1 : 150 (mm) OD 2 : 150 (mm) ID 1 : 110 (mm) ID 2 : 110 (mm)</p> <p>CONT : 6 VOL : 0.049</p>
<p>SFH 0224</p>	<p>Hydraulic Oil Filter Suction Wire Mesh supported Element YANMAR 172162-73700 HITACHI 4210224</p>  <p>H 1 : 135 (mm) H 2 : 128 (mm) OD 1 : 150 (mm) OD 2 : 150 (mm) ID 1 : 87 (mm) Thread Size : M10X1.5-6H</p> <p>CONT : 9 VOL : 0.029</p>	<p>SFH 0542</p>	<p>Hydraulic Oil Filter Spin-On HITACHI 4252563 HITACHI 71497010</p>  <p>H 1 : 147.5 (mm) H 2 : 136 (mm) OD 1 : 93 (mm) Thread Size : 1 1/8-16 UNF-2B</p> <p>CONT : 12 VOL : 0.025</p>	<p>SFH 2410</p>	<p>Hydraulic Oil Filter Metal End Cap Element HITACHI 3502410-N KOBELCO H 401</p>  <p>H 1 : 291 (mm) H 2 : 277 (mm) OD 1 : 90 (mm) OD 2 : 90 (mm) ID 1 : 46.6 (mm) ID 2 : 46.6 (mm)</p> <p>CONT : 20 VOL : 0.073</p>



To order, please call:
+1 8448 BE SURE; +1 (925) 566-8863















FOR REFERENCE ONLY - REPRESENTATIVE PICTURE ONLY



Email :
order@surefilter.us









Product Guide

<p>SFH 3064</p>  <p>CONT : 6 VOL : 0.081</p>	<p>Hydraulic Oil Filter Return Metal End Cap Element HITACHI YA00033064</p> <p>H 1 : 465.5 (mm) H 2 : 431 (mm) OD 1 : 150 (mm) OD 2 : 154 (mm) ID 1 : 98 (mm)</p>	<p>SFH 4132</p>  <p>CONT : 25 VOL : 0.069</p>	<p>Hydraulic Oil Filter Aluminium casting end cap, Element HITACHI 4294132</p> <p>H 1 : 211 (mm) H 2 : 180 (mm) OD 1 : 90 (mm) OD 2 : 90 (mm) ID 1 : 41.5 (mm) Thread Size : M40X2</p>	<p>SFH 6135</p>  <p>CONT : 6 VOL : 0.030</p>	<p>Hydraulic Oil Filter Transmission Metal End Cap Element ALLISON 23018853 GENERAL MOTORS 23018853 ALLISON 23049374 GENERAL MOTORS 23049374</p> <p>H 1 : 426.5 (mm) H 2 : 424 (mm) OD 1 : 95 (mm) OD 2 : 95 (mm) ID 1 : 55 (mm)</p>
<p>SFH 3065</p>  <p>CONT : 6 VOL : 0.080</p> <p>Note : BPV=1.5 kgf/cm2</p>	<p>Hydraulic Oil Filter Return Metal End Cap Element HITACHI YA00033065</p> <p>H 1 : 461.5 (mm) H 2 : 431 (mm) OD 1 : 154 (mm) OD 2 : 150 (mm) ID 1 : 98 (mm)</p>	<p>SFH 4135</p>  <p>CONT : 50 VOL : 0.012</p> <p>Note : Wiremesh type uses SFH 8400</p>	<p>Hydraulic Oil Filter Metal End Cap Element Cellulose media HYUNDAI 31E3-0018 HITACHI 4294135 YAMASHIN DT-04-10-10 KUBOTA R1411-64930</p> <p>H 1 : 87 (mm) H 2 : 83.5 (mm) OD 1 : 42.5 (mm) OD 2 : 42.5 (mm) ID 1 : 21.5 (mm)</p>	<p>SFH 6141</p>  <p>CONT : 12 VOL : 0.019</p> <p>Note : Seat assy zinc coating</p>	<p>Hydraulic Oil Filter Spin-On KOBELCO 2446U141S2 INTERNATIONAL HARVESTER 75912103</p> <p>H 1 : 130 (mm) OD 1 : 93 (mm) Thread Size : 1 1/8-16 UNF-2B Gasket Type : Round</p>
<p>SFH 3321</p>  <p>CONT : 6 VOL : 0.023</p>	<p>Hydraulic Oil Filter Spin-On SDLG 11214484 KOMATSU 113-60-43320 KOMATSU 113-60-43321 VOLVO 14524171 HITACHI 4205684</p> <p>H 1 : 171 (mm) OD 1 : 125 (mm) Thread Size : M48X2-6H Gasket Type : Round</p>	<p>SFH 4729</p>  <p>CONT : 12 VOL : 0.030</p>	<p>Hydraulic Oil Filter Transmission Spin-On With Microfiber media J.C.BAMFORD 32925905 ZF 501323154 CASE 8603535 CASE 87519452 JOHN DEERE AT336140</p> <p>H 1 : 199 (mm) OD 1 : 94.5 (mm) Thread Size : 1 3/8-12 UNF-2B Thread Stud Size : M24X1.5-6H Gasket Type : Square</p>	<p>SFH 65561</p>  <p>CONT : 12 VOL : 0.004</p>	<p>Hydraulic Oil Filter Metal End Cap Element KOMATSU 154-15-65561</p> <p>H 1 : 85.5 (mm) H 2 : 82.5 (mm) OD 1 : 42.5 (mm) ID 1 : 21.5 (mm)</p>
<p>SFH 3773</p>  <p>CONT : 4 VOL : 0.067</p> <p>Note : BPV=1.5 kgf/cm2</p>	<p>Hydraulic Oil Filter Return Metal End Cap Element HITACHI 4443773 HITACHI 4448402 SUNWARD 730401000068 SANY B222100000233 XGMA EF-058</p> <p>H 1 : 464.5 (mm) H 2 : 431 (mm) OD 1 : 150 (mm) OD 2 : 150 (mm) ID 1 : 98 (mm)</p>	<p>SFH 5299</p>  <p>CONT : 4 VOL : 0.035</p>	<p>Hydraulic Oil Filter Metal End Cap Element HITACHI 4185299</p> <p>H 1 : 304 (mm) H 2 : 254 (mm) OD 1 : 140 (mm) OD 2 : 140 (mm) ID 1 : 20 (mm) ID 2 : 20 (mm)</p>	<p>SFH 6608</p>  <p>CONT : 6 VOL : 0.080</p> <p>Note : High performance grade uses SFH 3331</p>	<p>Hydraulic Oil Filter Metal End Cap Element HITACHI 4656608</p> <p>H 1 : 450 (mm) H 2 : 437 (mm) OD 1 : 154 (mm) OD 2 : 150 (mm) ID 1 : 95 (mm) ID 2 : 98 (mm)</p>
<p>SFH 4130</p>  <p>CONT : 50 VOL : 0.017</p>	<p>Hydraulic Oil Filter Metal End Cap Element MANITOU 15512-00703 HITACHI 4294130</p> <p>H 1 : 52 (mm) H 2 : 48.5 (mm) OD 1 : 42.5 (mm) OD 2 : 42.5 (mm) ID 1 : 21.5 (mm)</p>	<p>SFH 5577</p>  <p>CONT : 20 VOL : 0.061</p>	<p>Hydraulic Oil Filter Wire Mesh supported Element CATERPILLAR 209-6002 HITACHI 4285577</p> <p>H 1 : 137 (mm) H 2 : 129.5 (mm) OD 1 : 124 (mm) OD 2 : 124 (mm) ID 1 : 73.4 (mm) Thread Size : M10X1.5-6H</p>	<p>SFH 6702</p>  <p>CONT : 12 VOL : 0.048</p>	<p>Hydraulic Oil Filter Plastic Element HITACHI E12596702</p> <p>H 1 : 421 (mm) H 2 : 406 (mm) OD 1 : 80 (mm) OD 2 : 80 (mm) ID 1 : 49 (mm)</p>

















Product Guide

<p>SFH 6705</p>  <p>CONT : 6 VOL : 0.081</p>	<p>Hydraulic Oil Filter Element Cellulose media</p> <p>HITACHI 4206705 HITACHI 4287061 KOMATSU F25701500 SUMITOMO KRJ 3836</p> <p>H 1 : 455 (mm) H 2 : 450 (mm) OD 1 : 150 (mm) OD 2 : 150 (mm) ID 1 : 110 (mm) ID 2 : 110 (mm)</p>	<p>SFH 7634</p>  <p>CONT : 9 VOL : 0.173</p>	<p>Hydraulic Oil Filter Metal End Cap Element</p> <p>KOMATSU 07063-01383 KOMATSU 208-60-61150 HITACHI 4287634</p> <p>H 1 : 450 (mm) OD 1 : 180 (mm) OD 2 : 180 (mm) ID 1 : 110 (mm) ID 2 : 110 (mm)</p>	<p>SFO 0048</p>  <p>CONT : 12 VOL : 0.034</p>	<p>Oil Filter By Pass Spin-On</p> <p>ISUZU 1-13240048-1 ISUZU 1-13240048-2 ISUZU 1-13240059-0</p> <p>H 1 : 162 (mm) OD 1 : 110 (mm) Thread Size : M20X1.5-6H Gasket Type : Square</p>
<p>SFH 6837</p>  <p>CONT : 12 VOL : 0.034</p>	<p>Hydraulic Oil Filter Transmission Spin-On</p> <p>LIUGONG 0750131053ZE HITACHI 4230376 HITACHI 4286837 KOMATSU BW252116</p> <p>H 1 : 200 (mm) OD 1 : 93 (mm) Thread Size : 1-12 UNF-2B Thread Nut Size : M24X1.5 BPV (kg/cm2) : 2.5 Gasket Type : Square</p>	<p>SFH 7841</p>  <p>CONT : 25 VOL : 0.015</p>	<p>Hydraulic Oil Filter Metal End Cap Element</p> <p>HITACHI 4207841 HITACHI 4207841A HITACHI 4370435</p> <p>H 1 : 152 (mm) H 2 : 146.5 (mm) OD 1 : 51 (mm) OD 2 : 51 (mm) ID 1 : 23.5 (mm)</p>	<p>SFO 0105</p>  <p>CONT : 6 VOL : 0.029</p>	<p>Oil Filter Full Flow Spin-On</p> <p>ISUZU 1-13200768-1 ISUZU 1-13240105-0 HINO 15607-1420</p> <p>H 1 : 248 (mm) OD 1 : 121 (mm) Thread Size : 1 3/8-16 UNF-2B Gasket Type : Square</p>
<p>SFH 7353</p>  <p>CONT : 10 VOL : 0.078</p>	<p>Hydraulic Oil Filter Metal End Cap Element</p> <p>DAEWOO 2474-9003B DAEWOO 2474-9008 HITACHI 4227353</p> <p>H 1 : 456 (mm) H 2 : 438 (mm) OD 1 : 112 (mm) OD 2 : 112 (mm) ID 1 : 66 (mm) ID 2 : 66 (mm)</p>	<p>SFH 8239</p>  <p>CONT : 50 VOL : 0.024</p>	<p>Hydraulic Oil Filter Metal End Cap Element</p> <p>HITACHI 4488239</p> <p>H 1 : 111.5 (mm) H 2 : 108.5 (mm) OD 1 : 42.5 (mm) OD 2 : 42.5 (mm) ID 1 : 21.5 (mm)</p>	<p>SFO 0132</p>  <p>CONT : 12 VOL : 0.043</p> <p>Note : Metal Protector</p>	<p>Oil Filter Full Flow Metal End Cap Element</p> <p>GENERAL MOTORS 357304 GENERAL MOTORS 5573014 GENERAL MOTORS 5573102</p> <p>H 1 : 231 (mm) H 2 : 227 (mm) OD 1 : 109 (mm) OD 2 : 109 (mm) ID 1 : 37 (mm) ID 2 : 37 (mm)</p>
<p>SFH 7402</p>  <p>CONT : 12 VOL : 0.022</p> <p>Note : 5 micron</p>	<p>Hydraulic Oil Filter Spin-On Synthetic Media</p> <p>HYUNDAI 46321-22015 INGERSOLL RAND 575129311 CATERPILLAR 77-5795</p> <p>H 1 : 147.5 (mm) OD 1 : 94 (mm) Thread Size : 1 1/2-16 UN-2B</p>	<p>SFH 8651</p>  <p>CONT : 12 VOL : 0.035</p>	<p>Hydraulic Oil Filter Wire Mesh supported Element</p> <p>HITACHI 4648651</p> <p>H 1 : 135 (mm) H 2 : 126 (mm) OD 1 : 125 (mm) OD 2 : 125 (mm) ID 1 : 89 (mm) Thread Size : M10X1.5-6H</p>	<p>SFO 0163</p>  <p>CONT : 12 VOL : 0.056</p>	<p>Oil Filter By Pass Spin-On</p> <p>ISUZU 1-13240163-0 ISUZU 1-13240163-1 ISUZU 1-13240163-2 HITACHI 4371313</p> <p>H 1 : 249 (mm) OD 1 : 120 (mm) Thread Size : 1 3/8-16 UNF-2B Gasket Type : Square</p>
<p>SFH 7425</p>  <p>CONT : 12 VOL : 0.037</p> <p>Note : For Hitachi</p>	<p>Hydraulic Oil Filter Wire Mesh supported Element</p> <p>HITACHI 4687425</p> <p>H 1 : 148.5 (mm) H 2 : 140 (mm) OD 1 : 124 (mm) ID 1 : 58.5 (mm) Thread Size : M10X1.5</p>	<p>SFO 0009</p>  <p>CONT : 6 VOL : 0.031</p> <p>Note : Multilayer</p>	<p>Oil Filter Combination Spin-On Seamless</p> <p>J.C.BAMFORD 02/910965 CUMMINS 3401544 KOMATSU 6742-01-4540</p> <p>H 1 : 294 (mm) OD 1 : 118 (mm) Thread Size : 2 1/4-12 UNF-2B Gasket Type : Square</p>	<p>SFO 0220</p>  <p>CONT : 12 VOL : 0.050</p>	<p>Oil Filter Full Flow Spin-On</p> <p>VOLVO 478736 VOLVO 478736-2 RENAULT 5 001 846 642</p> <p>H 1 : 259 (mm) OD 1 : 108 (mm) Thread Size : 1 1/8-16 UNF-2B Gasket Type : Square</p>



Product Guide

<p>SFO 0535 Oil Filter Full Flow Spin-On</p> <p>YANMAR 119305-35151</p>  <p>H 1 : 65 (mm) OD 1 : 65 (mm) Thread Size : M20X1.5-6H BPV (kg/cm2) : 1.0 ADBV : YES</p> <p>CONT : 50 VOL : 0.021</p>	<p>SFO 1420 Oil Filter Full Flow Spin-On</p> <p>MAHINDRA 14501673990 HITACHI 26300-21010 CHRYSLER 4186267</p>  <p>H 1 : 78 (mm) OD 1 : 87 (mm) Thread Size : M20X1.5-6H BPV (kg/cm2) : 1.0 ADBV : YES Gasket Type : Square</p> <p>CONT : 50 VOL : 0.038</p>	<p>SFO 2670 Oil Filter Full Flow Spin-On Cellulose media</p> <p>CUMMINS 3313279 MITSUBISHI 37540-01101 CUMMINS 3889310 KOMATSU CULF-670</p>  <p>H 1 : 246 (mm) OD 1 : 118 (mm) Thread Size : 1 1/2-12 UNF-2B Gasket Type : Square</p> <p>CONT : 12 VOL : 0.056</p>
<p>SFO 0600 Oil Filter Combination Spin-On</p> <p>HINO 15607-1600 HINO 15607-1830</p>  <p>H 1 : 200 (mm) OD 1 : 110 (mm) Thread Size : 1 1/2-16 UN-2B Gasket Type : Square</p> <p>CONT : 12 VOL : 0.040</p> <p>Note : single element version uses SFO 2198</p>	<p>SFO 1638 Oil Filter Full Flow Spin-On</p> <p>ISUZU 1-13240062-2 ISUZU 1-87811638-0 MC CORMICK (LANDINI-ARGO) MCA77537</p>  <p>H 1 : 203 (mm) OD 1 : 118 (mm) Thread Size : 1 1/2-12 UNF-2B</p> <p>CONT : 6 VOL : 0.024</p>	<p>SFO 2692 Oil Filter By Pass Spin-On</p> <p>J.C.BAMFORD 2800359 HITACHI 4429725 FIAT-HITACHI 71422692 NEW HOLLAND (CNH) 71422692 ISUZU 8-97026134-2</p>  <p>H 1 : 200 (mm) OD 1 : 110 (mm) Thread Size : M20X1.5-6H Gasket Type : Square</p> <p>CONT : 12 VOL : 0.042</p>
<p>SFO 1195 Oil Filter By Pass Metal End Cap Element</p> <p>HITACHI 4231195</p>  <p>H 1 : 166 (mm) H 2 : 132 (mm) OD 1 : 160.5 (mm) OD 2 : 144 (mm) Thread Size : M16X2-6H</p> <p>CONT : 10 VOL : 0.058</p> <p>Note : Type of non multy layer use SFO 3601</p>	<p>SFO 178A Oil Filter Full Flow Spin-On</p> <p>HOLDEN 8-9421-7272-2</p>  <p>H 1 : 95 (mm) OD 1 : 93 (mm) Thread Size : M20X1.5-6H BPV (kg/cm2) : 1.0 ADBV : YES Gasket Type : Square</p> <p>CONT : 25 VOL : 0.037</p> <p>Note : SFO 7272,SFO 9708 (bottom plate difference)</p>	<p>SFO 2777 Oil Filter By Pass Spin-On</p> <p>ISUZU 1-87310093-0 CATERPILLAR 1W-8845 J.C.BAMFORD 32/919502 HITACHI 4285964</p>  <p>H 1 : 246.5 (mm) OD 1 : 115 (mm) Thread Size : 1 3/8-16 UN-2B Gasket Type : Square</p> <p>CONT : 12 VOL : 0.056</p>
<p>SFO 1256 Oil Filter Combination Spin-On</p> <p>HITACHI 4448336 HITACHI 4484495 HITACHI 4661256</p>  <p>H 1 : 210 (mm) OD 1 : 120 (mm) Thread Size : 1 1/2-12 UNF-2B BPV (kg/cm2) : 1.0</p> <p>CONT : 12 VOL : 0.048</p> <p>Note : SFO 4495(bottom plate difference)</p>	<p>SFO 1940 Oil Filter Full Flow Metal End Cap Element</p> <p>ISUZU 13240-085/1 ISUZU 5-87310336-0 ISUZU 5-87810239-0</p>  <p>H 1 : 146 (mm) H 2 : 143 (mm) OD 1 : 83 (mm) OD 2 : 83 (mm) ID 1 : 17 (mm) ID 2 : 17 (mm)</p> <p>CONT : 50 VOL : 0.059</p>	<p>SFO 3264 Oil Filter Full Flow Metal End Cap Element</p> <p>ISUZU 9-13240098-0 ISUZU 9-13240106-0 ISUZU 9-13240106-1</p>  <p>H 1 : 177 (mm) H 2 : 161 (mm) OD 1 : 104.5 (mm) OD 2 : 104 (mm) ID 1 : 49 (mm) ID 2 : 15 (mm)</p> <p>CONT : 50 VOL : 0.113</p>
<p>SFO 1351 Oil Filter By Pass Metal End Cap Element</p> <p>HINO 15607-1350 HINO 15607-1351 HINO 15607-1530</p>  <p>H 1 : 218 (mm) OD 1 : 122 (mm) OD 2 : 122 (mm) ID 1 : 17.5 (mm) ID 2 : 17.5 (mm)</p> <p>CONT : 16 VOL : 0.074</p>	<p>SFO 2300 Oil Filter Combination Spin-On Synthetic Media</p> <p>KOMATSU 6742-01-4120</p>  <p>H 1 : 280 (mm) OD 1 : 121 (mm) Thread Size : 2 1/4-12 UNF-2B Gasket Type : Square</p> <p>CONT : 6 VOL : 0.031</p>	<p>SFO 3265 Oil Filter Full Flow Metal End Cap Element</p> <p>ISUZU 1-87810059-0 ISUZU 1-87810059-1 ISUZU 1-87810065-0</p>  <p>H 1 : 248.5 (mm) H 2 : 232 (mm) OD 1 : 104.5 (mm) OD 2 : 104 (mm) ID 1 : 49 (mm) ID 2 : 15 (mm)</p> <p>CONT : 25 VOL : 0.085</p>



Product Guide

SFO 3345 Oil Filter Full Flow Spin-On



HYUNDAI 11E1-70110
GENERAL MOTORS 25011995
CUMMINS 3903224
KOMATSU 6732-51-5140
CASE J908616

H 1 : 136 (mm)
OD 1 : 93 (mm)
Thread Size : 1-16 UNF-2B
Gasket Type : Square

CONT : 12
VOL : 0.019

SFO 3853 Oil Filter Full Flow Spin-On



KOBELCO 2451U309-1
HITACHI 4183853
HITACHI 4439863

H 1 : 150 (mm)
OD 1 : 102 (mm)
Thread Size : 1-12 UNF-2B
BPV (kg/cm2) : 2.0 - 2.5
ADBV : YES
Gasket Type : Square

CONT : 12
VOL : 0.031

SFO 4459 Oil Filter Full Flow Spin-On



MAZDA 0000-23-0370
MAZDA 0370-23-802-91
MAZDA 0370-23-8020
MAZDA 0370-23-802B
GENERAL MOTORS 12337532

H 1 : 85 (mm)
OD 1 : 80 (mm)
Thread Size : M20X1.5-6H
BPV (kg/cm2) : 1.0
ADBV : YES
Gasket Type : Square

CONT : 12
VOL : 0.010

SFO 3349 Oil Filter Full Flow Spin-On Cellulose media



J.C.BAMFORD 02/910140
J.C.BAMFORD 02/910140A
CUMMINS 3903264

H 1 : 172 (mm)
OD 1 : 93 (mm)
Thread Size : 1-16 UNF-2B
Gasket Type : Square

CONT : 12
VOL : 0.023

SFO 3937 Oil Filter Full Flow Spin-On Cellulose media



J.C.BAMFORD 32/925413
CUMMINS 3937736

H 1 : 174 (mm)
OD 1 : 93 (mm)
Thread Size : 1 1/8-16 UNF-2B
Gasket Type : Square

CONT : 12
VOL : 0.024

Note : Glass Fiber media uses SFO 3938

SFO 4754 Oil Filter Full Flow Metal End Cap Element



ISUZU 1-13240109-1
NISSAN 15208-61501
NISSAN 15208-61525
NISSAN 15208-Z5000
NISSAN 15208-Z9025

H 1 : 165 (mm)
H 2 : 160 (mm)
OD 1 : 104 (mm)
OD 2 : 104 (mm)
ID 1 : 15 (mm)
ID 2 : 49 (mm)

CONT : 50
VOL : 0.107

SFO 3594 Oil Filter Combination Spin-On



FIAT 1902102
IVECO 1903629
IVECO 1903715
IVECO 1907584

H 1 : 211 (mm)
OD 1 : 108 (mm)
Thread Size : M30X2-6H
BPV (kg/cm2) : YES
ADBV : YES
Gasket Type : Square

CONT : 6
VOL : 0.022

SFO 4054 Oil Filter Full Flow Spin-On



MERCEDES-BENZ 001 184 96 01
DEUTZ 116004
KHD(KLOCKNER-HUMBOLT-DEUTZ) 117 4421
DEUTZ 1173430

H 1 : 206 (mm)
OD 1 : 93 (mm)
Thread Size : 1-12 UNF-2B
BPV (kg/cm2) : 2.0 - 2.5
ADBV : YES
Gasket Type : Square

CONT : 12
VOL : 0.028

Note : With Grip

SFO 5050 Oil Filter By Pass Can-type Depth



KOMATSU 6610-51-5050

H 1 : 382 (mm)
H 2 : 376 (mm)
OD 1 : 197 (mm)
OD 2 : 197 (mm)
ID 1 : 22 (mm)
ID 2 : 22 (mm)

CONT : 6
VOL : 0.111

SFO 3601 Oil Filter By Pass Metal End Cap Element



HITACHI 4231195

H 1 : 169 (mm)
H 2 : 131 (mm)
OD 1 : 165 (mm)
OD 2 : 165 (mm)
Thread Size : M16X2-6H

CONT : 9
VOL : 0.054

Note : MultyLayer Version SFO 1195

SFO 4302 Oil Filter Full Flow Spin-On



NISSAN 15208-HC400
HINO 15607-1920
FORD 3396825
MAZDA JEYO-14-302

H 1 : 85 (mm)
OD 1 : 68 (mm)
Thread Size : M20X1.5-6H
BPV (kg/cm2) : 1.0
ADBV : YES
Gasket Type : Round

CONT : 50
VOL : 0.029

Note : Gasket Square type uses SFO 4110B

SFO 5400 Oil Filter By Pass Spin-On



MITSUBISHI 37540-02100

H 1 : 250 (mm)
OD 1 : 125 (mm)
Thread Size : 1 3/8-16 UNF-2B
Gasket Type : Square

CONT : 6
VOL : 0.031

Note : Is a long version of SFO 1800

SFO 3628 Oil Filter Combination Spin-On



FIAT 1902047
IVECO 1902047
IVECO 1902076

H 1 : 143 (mm)
OD 1 : 108.5 (mm)
Thread Size : 3/4-16 UNF-2B
BPV (kg/cm2) : 2.0
ADBV : YES
Gasket Type : Square

CONT : 12
VOL : 0.028

SFO 4407 Oil Filter Full Flow Spin-On



J.C.BAMFORD 02/100073
PERKINS 26540347
PERKINS 2654407

H 1 : 168 (mm)
OD 1 : 93 (mm)
Thread Size : 3/4-16 UNF-2B
BPV (kg/cm2) : 1.0
ADBV : YES
Gasket Type : Square

CONT : 25
VOL : 0.050

SFO 6007 Oil Filter Full Flow Spin-On



CATERPILLAR 1R-0714
HITACHI 4429728
FIAT 71455273
MITSUBISHI ME034878
MITSUBISHI ME088519

H 1 : 162 (mm)
OD 1 : 108.5 (mm)
Thread Size : 1 1/8-16 UNF-2B
Gasket Type : Square

CONT : 12
VOL : 0.036



Product Guide

SFO 6081 Oil Filter Spin-On



H 1 : 199 (mm)
OD 1 : 110 (mm)
Thread Size : 1 1/2-12 UNF-2B
BPV (kg/cm2) : 2.0
Gasket Type : Square

CONT : 0
VOL : 0.000

SFO 8336 Oil Filter Combination Spin-On

HITACHI 4448336



H 1 : 252 (mm)
OD 1 : 120 (mm)
Thread Size : 1 1/2-12 UNF-2B
Gasket Type : Square

CONT : 6
VOL : 0.029

SFR 1216FW Fuel/Water Separator Spin-On With Drain

CUMMINS 3309437
CUMMINS 3313304
HITACHI 4202934



H 1 : 311.4 (mm)
OD 1 : 115.5 (mm)
Thread Size : 1 1/4-12 UNF-2B
Gasket Type : Square

CONT : 6
VOL : 0.036

Note : Drain Plug

SFO 7036 Oil Filter Full Flow Spin-On

TEREX 15273756
DETROIT DIESEL 23526919
HITACHI E1297440



H 1 : 305 (mm)
OD 1 : 136 (mm)
Thread Size : 1 1/2-16 UN-2B
BPV (kg/cm2) : YES
Gasket Type : Square

CONT : 9
VOL : 0.068

SFO 9005 Oil Filter Full Flow Spin-On

NISSAN 15209-0T000
NISSAN 15209-T9000
NISSAN 15209-T9001



H 1 : 200 (mm)
OD 1 : 93 (mm)
Thread Size : 1-12 UNF-2B
ADBV : YES
Gasket Type : Round

CONT : 25
VOL : 0.059

SFR 1280FW Fuel/Water Separator Spin-On

J.C.BAMFORD 02/910150
J.C.BAMFORD 02/910150A
HYUNDAI 11E1-70210
CUMMINS 3903410
LIUGONG 53C0051



H 1 : 164 (mm)
OD 1 : 93 (mm)
Thread Size : 13/16-18 UNF-2B
Thread Nut Size : M14X2-6H
Gasket Type : Square

CONT : 12
VOL : 0.027

SFO 7502 Oil Filter Full Flow Spin-On

ISUZU 132400930
NISSAN 15209-J1800
NISSAN 15209-Y7500



H 1 : 164 (mm)
OD 1 : 80 (mm)
Thread Size : 3/4-16 UNF-2B
Gasket Type : Round

CONT : 36
VOL : 0.086

SFO 9708 Oil Filter Full Flow Spin-On

ISUZU 8-94430983-0
ISUZU 8-97049708-1



H 1 : 100 (mm)
OD 1 : 90 (mm)
Thread Size : M20X1.5-6H
BPV (kg/cm2) : 1.0
ADBV : YES
Gasket Type : Round

CONT : 25
VOL : 0.029

SFR 2130FW Fuel/Water Separator Primary Plastic Element 30 Micron

HITACHI 4448737



H 1 : 244 (mm)
OD 1 : 111 (mm)
OD 2 : 128 (mm)
ID 1 : 16.5 (mm)
ID 2 : 21 (mm)

CONT : 16
VOL : 0.066

SFO 7566 Oil Filter Full Flow Spin-On

IVECO 1901603
IVECO 1907566
KUBOTA HH160-32430



H 1 : 184 (mm)
OD 1 : 108 (mm)
Thread Size : 3/4-16 UNF-2B
BPV (kg/cm2) : YES
ADBV : YES
Gasket Type : Square

CONT : 6
VOL : 0.019

SFO 9726 Oil Filter Full Flow Spin-On

HITACHI 4429726



H 1 : 206 (mm)
OD 1 : 108 (mm)
Thread Size : 1 1/2-12 UNF-2B
Gasket Type : Square

CONT : 6
VOL : 0.020

Note : Drain Nut

SFR 3112FW Fuel/Water Separator Spin-On High Efficiency

CUMMINS 3089916
KOMATSU 600-311-3110
KOMATSU 600-311-3111
KOMATSU 600-319-3111
KOMATSU 600-319-3111A



H 1 : 311.4 (mm)
H 2 : 286 (mm)
OD 1 : 118 (mm)
Thread Size : 1 1/4-12 UNF-2B

CONT : 6
VOL : 0.036

Note : High efficiency filter for high pressure fuel injection systems

SFO 8241 Oil Filter By Pass Metal End Cap Element

HINO 15607-1660
HITACHI 4208241
HITACHI 4208241-1



H 1 : 192.5 (mm)
H 2 : 155.5 (mm)
OD 1 : 165 (mm)
OD 2 : 165 (mm)
Thread Size : M16X1.0-6H

CONT : 6
VOL : 0.042

SFR 1212FW Fuel/Water Separator Spin-On

ISUZU 1-13240044-1
CUMMINS 3308638
CUMMINS 3315843
SUNWARD 75020101130



H 1 : 174 (mm)
OD 1 : 93 (mm)
Thread Size : 1-14 UNS-2B
Thread Size : M14X2.0
Gasket Type : Square

CONT : 12
VOL : 0.031

SFR 5110FW Fuel/Water Separator Spin-On 10 Micron

CATERPILLAR 256-8753
CUMMINS 3329289
HITACHI 4377880
SANY B222100000596

















H 1 : 245 (mm)
OD 1 : 93 (mm)
Thread Size : 1-14 UNS-2B
Gasket Type : Square

CONT : 6
VOL : 0.018



Product Guide

<p>SFR 7134FW Fuel/Water Separator Spin-On Without Bowl HITACHI YA00037134</p>  <p>H 1 : 191 (mm) OD 1 : 108 (mm) Thread Size : 1-14 UNS-2B</p> <p>CONT : 12 VOL : 0.039</p> <p>Note : bowl not included</p>	<p>SFR 9732FW Fuel/Water Separator Spin-On</p> <p>CUMMINS 3973233 CASE 87356193 NEW HOLLAND (CNH) 87356194 SANY B22210000444</p>  <p>H 1 : 164 (mm) OD 1 : 93 (mm) Thread Size : 1-14 UNS-2B Gasket Type : Square</p> <p>CONT : 12 VOL : 0.030</p>	<p>SFW 2073 Coolant Filter Spin-On</p> <p>CUMMINS 3315115 CUMMINS 3316462 CUMMINS 4058964</p>  <p>H 1 : 100 (mm) OD 1 : 93 (mm) Thread Size : 11/16-16 UNF-2B Gasket Type : Square</p> <p>CONT : 12 VOL : 0.017</p> <p>Note : Coolants = 8 units</p>
<p>SFR 8633FW Fuel/Water Separator Primary Spin-On With Drain</p> <p>JOHN DEERE RE508633 JOHN DEERE RE58376 JOHN DEERE RE62423</p>  <p>H 1 : 200 (mm) H 2 : 172 (mm) OD 1 : 80 (mm) ID 1 : 17 (mm)</p> <p>CONT : 25 VOL : 0.044</p> <p>Note : standard flow</p>	<p>SFS 4900 Fuel Filter Plastic body In-Line</p> <p>MITSUBISHI MM304900</p>  <p>H 1 : 99 (mm) OD 1 : 45 (mm) Inlet : 11 (mm) Outlet : 11 (mm)</p> <p>CONT : 0 VOL : 0.000</p>	<p>SFW 2074 Coolant Filter Spin-On</p> <p>CUMMINS 3100307 CUMMINS 3315114 CUMMINS 3316053</p>  <p>H 1 : 136 (mm) OD 1 : 93 (mm) Thread Size : 11/16-16 UNF-2B Gasket Type : Square</p> <p>CONT : 12 VOL : 0.021</p> <p>Note : Coolants = 12 units</p>
<p>SFR 9001FW Fuel/Water Separator Spin-On 10 Micron</p> <p>MERCEDES-BENZ 000 470 04 69 MERCEDES-BENZ A 000 470 04 69 MERCEDES-BENZ R90-MER-01</p>  <p>H 1 : 217 (mm) OD 1 : 108 (mm) Thread Size : 1-14 UNS-2B Gasket Type : Square</p> <p>CONT : 6 VOL : 0.043</p> <p>Note : bowl not included</p>	<p>SFS 5079 Fuel Filter Metal body In-Line</p> <p>CUMMINS 3826094 NEW HOLLAND (CNH) 86597473</p>  <p>H 1 : 96 (mm) OD 1 : 44.5 (mm) OD 2 : 44.5 (mm) Inlet : 10 (mm) Outlet : 10 (mm)</p> <p>CONT : 12 VOL : 0.005</p> <p>Note : Wiremesh Element</p>	<p>SFW 2075 Coolant Filter Spin-On</p> <p>HITACHI 4228689 INGERSOLL RAND 57165805</p>  <p>H 1 : 136 (mm) OD 1 : 93 (mm) Thread Size : 11/16-16 UNF-2B Gasket Type : Square</p> <p>CONT : 12 VOL : 0.021</p> <p>Note : coolant=15 units</p>
<p>SFR 9001FWB Fuel/Water Separator Spin-On With Bowl 10 Micron</p> <p>MERCEDES-BENZ R90-MER-01</p>  <p>H 1 : 308 (mm) OD 1 : 108 (mm) Thread Size : 1-14 UNS-2B</p> <p>CONT : 12 VOL : 0.059</p> <p>Note : SFR 9001FW and SB 308Y</p>	<p>SFW 2054 Coolant Filter Spin-On</p> <p>GENERAL MOTORS 23507189 FIAT 4393504 CASE 441365C1</p>  <p>H 1 : 136 (mm) OD 1 : 93 (mm) Thread Size : 11/16-16 UNF-2B Gasket Type : Square</p> <p>CONT : 12 VOL : 0.021</p> <p>Note : Coolants = 15 units</p>	<p>SFW 2076 Coolant Filter Spin-On</p> <p>CUMMINS 3318319 HITACHI 4266063</p>  <p>H 1 : 136 (mm) OD 1 : 93 (mm) Thread Size : 11/16-16 UNF-2B Gasket Type : Square</p> <p>CONT : 12 VOL : 0.022</p> <p>Note : Coolants = 23 units</p>
<p>SFR 9634FW Fuel/Water Separator Metal End Cap Element</p> <p>DETROIT DIESEL 23533816 MACK 301-SD-19B ALLIANCE ABP/N10G-FS19624 HITACHI E12981308</p>  <p>H 1 : 181.5 (mm) H 2 : 173.5 (mm) OD 1 : 101 (mm) OD 2 : 99.5 (mm) ID 1 : 17 (mm)</p> <p>CONT : 25 VOL : 0.071</p> <p>Note : Media 4 Micron</p>	<p>SFW 2071 Coolant Filter Spin-On</p> <p>CUMMINS 299080 CUMMINS 3100304 CUMMINS 3305367</p>  <p>H 1 : 100 (mm) OD 1 : 93 (mm) Thread Size : 11/16-16 UNF-2B Gasket Type : Square</p> <p>CONT : 12 VOL : 0.014</p> <p>Note : Coolants 4 units</p>	

To order, please call:
+1 8448 BE SURE; +1 (925) 566-8863

FOR REFERENCE ONLY - REPRESENTATIVE PICTURE ONLY

Email : order@surefilter.us