



Table of Contents

ENGINE APPLICATION	A
PRODUCT GUIDE	B



ENGINE APPLICATION

A



Engine Application

MODEL/APPLICATION	SURE NO
LIEBHERR	
631C (DOZERS) LIEBHERR D9406	
Hydraulic Oil Filter.....	SFH 0229
A300 (EXCAVATORS) DEUTZ F3/4L812	
Fuel Filter.....	SFF 0723
Oil Filter Full Flow.....	SFO 4018
A300 (EXCAVATORS) LIEBHERR F314L812D	
Fuel Filter.....	SFF 0723
Oil Filter Full Flow.....	SFO 4018
A308 (EXCAVATORS) S/N: 0158-UP , 1996-UP	
Air Filter Secondary.....	SFA F700S
Air Filter Primary.....	SFA 1089P
Oil Filter Full Flow.....	SFO 7124
A308 (EXCAVATORS) S/N: SR 0392-UP , 1996-UP	
Air Filter Secondary.....	SFA F700S
Air Filter Primary.....	SFA 1089P
Oil Filter Full Flow.....	SFO 7124
A308 (EXCAVATORS) S/N: TO-0157 , 1996-UP	
Air Filter Secondary.....	SFA F700S
Air Filter Primary.....	SFA 1089P
Oil Filter Full Flow.....	SFO 7124
A309 LITRONIC (EXCAVATORS) DEUTZ BF4M2012	
Coolant Filter.....	SFW 4685
Fuel/Water Separator.....	SFR 9001FWB
Fuel/Water Separator.....	SFR 9001FW
A309 TYPE 717 (EXCAVATORS) , 2004-UP	
Coolant Filter.....	SFW 4685
Fuel/Water Separator.....	SFR 9001FW
Fuel/Water Separator.....	SFR 9001FWB
Hydraulic Oil Filter.....	SFH 7601
Oil Filter Full Flow.....	SFO 4018
A310 (EXCAVATORS) DEUTZ , 1991-1995	
Air Filter Primary.....	SFA 1089P
Air Filter Secondary.....	SFA F700S
Fuel Filter.....	SFF 7122
Oil Filter Full Flow.....	SFO 7195
A310B (EXCAVATORS) DEUTZ BFM 1012 , 1995-UP	
Air Filter Primary.....	SFA 1088P
Air Filter Secondary.....	SFA 0800S
Coolant Filter.....	SFW 4685
Hydraulic Oil Filter.....	SFH 7601
Oil Filter Full Flow.....	SFO 4018
A312 (EXCAVATORS) DEUTZ BFM 1012 , 1994-UP	
Air Filter Primary.....	SFA 0800S
Coolant Filter.....	SFW 4685
Hydraulic Oil Filter.....	SFH 7601
Oil Filter Full Flow.....	SFO 4018

MODEL/APPLICATION	SURE NO
LIEBHERR	
A312 (EXCAVATORS) DEUTZ BFM 1012 , 1994-UP	
Air Filter Secondary.....	SFA 0800S
Coolant Filter.....	SFW 4685
Hydraulic Oil Filter.....	SFH 7601
Oil Filter Full Flow.....	SFO 4018
A312 (EXCAVATORS) KHD BF4M1012	
Air Filter Secondary.....	SFA 0800S
Oil Filter Full Flow.....	SFO 4018
A312 LITRONIC (EXCAVATORS) DEUTZ BF4M1013E	
Air Filter Primary.....	SFA 0500P
Coolant Filter.....	SFW 4685
Fuel Filter.....	SFF 1723
Oil Filter Full Flow.....	SFO 4054
A314 LITRONIC (EXCAVATORS) KHD BF4M1013EC , 2001-UP	
Air Filter Primary.....	SFA 0500P
Coolant Filter.....	SFW 4685
Fuel Filter.....	SFF 0723
Fuel Filter.....	SFF 1723
Fuel Filter.....	SFF 0006
Fuel/Water Separator Secondary...	SFR 0901FW
Fuel/Water Separator Secondary..	SFR 0901FWB
Oil Filter Full Flow.....	SFO 4054
A316 (EXCAVATORS) S/N: SR0269-UP , 1997-2001	
Air Filter Secondary.....	SFA 1000S
Air Filter Primary.....	SFA 0123P
Coolant Filter.....	SFW 4685
Fuel Filter.....	SFF 1723
Fuel Filter.....	SFF 0006
Oil Filter Full Flow.....	SFO 4054
A316 LITRONIC (EXCAVATORS) KHD BF4M1013EC , 2001-UP	
Air Filter Primary.....	SFA 0500P
Coolant Filter.....	SFW 4685
Fuel Filter.....	SFF 1723
Fuel Filter.....	SFF 0723
Fuel Filter.....	SFF 0006
Oil Filter Full Flow.....	SFO 4054
A531 (EXCAVATORS)	
Oil Filter Full Flow.....	SFO 9214
A902 LITRONIC (EXCAVATORS) 101	
Coolant Filter.....	SFW 2071
Fuel/Water Separator.....	SFR 1212FW
A900 (EXCAVATORS) DEUTZ	
Air Filter Primary.....	SFA 1088P
Air Filter Secondary.....	SFA 0800S
Air Filter Secondary.....	SFA 4589S
Fuel Filter.....	SFF 0723

MODEL/APPLICATION	SURE NO
LIEBHERR	
A900 (EXCAVATORS) DEUTZ	
Oil Filter Full Flow.....	SFO 4018
A900 LITRONIC (EXCAVATORS) DEUTZ	
Air Filter Primary.....	SFA 0123P
Air Filter Primary.....	SFA 1088P
Air Filter Secondary.....	SFA 1000S
Air Filter Secondary.....	SFA 0800S
Fuel Filter.....	SFF 0006
Fuel Filter.....	SFF 1723
Oil Filter Full Flow.....	SFO 4054
A900 LITRONIC (EXCAVATORS) DEUTZ BFM 1013	
Fuel Filter.....	SFF 0723
Fuel Filter.....	SFF 1723
A900B (EXCAVATORS) DEUTZ	
Air Filter Primary.....	SFA 1733PF
Air Filter Set.....	SFA 1950SET
Air Filter Primary.....	SFA 0123P
Air Filter Set.....	SFA 1733SET
Air Filter Secondary.....	SFA 1000S
Air Filter Secondary.....	SFA 4103S
Coolant Filter.....	SFW 4685
Fuel Filter.....	SFF 1723
Fuel Filter.....	SFF 0006
Oil Filter Full Flow.....	SFO 4054
Oil Filter Full Flow.....	SFO 4018
A900C (EXCAVATORS) DEUTZ BF4L913 , 1989-UP	
Hydraulic Oil Filter.....	SFH 0962
Oil Filter Full Flow.....	SFO 4054
A900C (EXCAVATORS) DEUTZ	
Air Filter Set.....	SFA 0434SET
Air Filter Primary.....	SFA 0434PF
Oil Filter Full Flow.....	SFO 4054
A900C LITRONIC (EXCAVATORS) LIEBHERR , 2004-UP	
Air Filter Primary.....	SFA 7638PF
Air Filter Secondary.....	SFA 5491S
Coolant Filter.....	SFW 2071
Fuel Filter.....	SFF 5427
Fuel/Water Separator Secondary...	SFR 2242FW
Oil Filter Full Flow.....	SFO 9627
A900ZW (EXCAVATORS)	
Air Filter Secondary.....	SFA 1000S
Air Filter Primary.....	SFA 0123P
Fuel Filter.....	SFF 1723
Fuel Filter.....	SFF 0006
Oil Filter Full Flow.....	SFO 4054
A901 (EXCAVATORS) DEUTZ F3L912	



To order, please call:
+1 8448 BE SURE; +1 (925) 566-8863

For Reference Only - May not be a direct cross

A 1



Email :
order@suresfilter.us



Engine Application

MODEL/APPLICATION	SURE NO
LIEBHERR	

MODEL/APPLICATION	SURE NO
LIEBHERR	

MODEL/APPLICATION	SURE NO
LIEBHERR	

A901
(EXCAVATORS)
DEUTZ F3L912
Air Filter Primary..... SFA 1052PF
Fuel Filter..... SFF 0723
Oil Filter Full Flow..... SFO 4018

A901B
(EXCAVATORS)
DEUTZ F3L912
Air Filter Primary..... SFA 1089P
Air Filter Primary..... SFA 1733PF
Air Filter Secondary..... SFA 4103S
Air Filter Primary..... SFA 1052PF
Air Filter Secondary..... SFA F700S
Air Filter Set..... SFA 1733SET
Air Filter Set..... SFA 1950SET
Fuel Filter..... SFF 0723
Oil Filter Full Flow..... SFO 4018

A901C
(EXCAVATORS)
DEUTZ F4L912
Air Filter Primary..... SFA 1088P
Air Filter Secondary..... SFA 0800S
Fuel Filter..... SFF 0723
Oil Filter Full Flow..... SFO 4018

A902
(EXCAVATORS)
DEUTZ F4/5L912
Air Filter Secondary..... SFA 4103S
Air Filter Secondary..... SFA 0490S
Air Filter Primary..... SFA 1733PF
Air Filter Set..... SFA 1733SET
Air Filter Set..... SFA 1950SET
Air Filter Primary..... SFA 0418P
Fuel Filter..... SFF 3291
Oil Filter Full Flow..... SFO 4018
Oil Filter Full Flow..... SFO 9627

A902
(EXCAVATORS)
LIEBHERR D904 NA
Air Filter Secondary..... SFA 0490S
Air Filter Primary..... SFA 0418P
Fuel Filter..... SFF 3291
Oil Filter Full Flow..... SFO 9627

A904
(EXCAVATORS)
S/N: 11107-UP
Air Filter Secondary..... SFA 1000S
Air Filter Primary..... SFA 0123P
Coolant Filter..... SFW 2071
Oil Filter Full Flow..... SFO 9627

A904
(EXCAVATORS)
S/N: 6920-11106
Air Filter Secondary..... SFA 1000S
Air Filter Primary..... SFA 0123P
Coolant Filter..... SFW 2071
Oil Filter Full Flow..... SFO 9627

A904 LITRONIC
(EXCAVATORS)
S/N: 11107-UP , 1999-UP
Air Filter Secondary..... SFA 1000S
Air Filter Primary..... SFA 0123P

A904 LITRONIC
(EXCAVATORS)
S/N: 11107-UP , 1999-UP
Coolant Filter..... SFW 2071
Oil Filter Full Flow..... SFO 9627

A904C
(EXCAVATORS)
LIEBHERR , 2004-UP
Air Filter Secondary..... SFA 5491S
Air Filter Primary..... SFA 7638PF
Coolant Filter..... SFW 2071
Fuel Filter..... SFF 5427
Fuel/Water Separator Secondary... SFR 2242FW
Oil Filter Full Flow..... SFO 9627

A904C LITRONIC
(EXCAVATORS)
LIEBHERR D924TI-E
Air Filter Primary..... SFA 7638PF
Air Filter Secondary..... SFA 5491S
Coolant Filter..... SFW 2071
Fuel Filter..... SFF 5427
Fuel/Water Separator..... SFR 4302FW
Fuel/Water Separator..... SFR 90T1FW
Fuel/Water Separator..... SFR 90T1FWB
Oil Filter Full Flow..... SFO 9627
Oil Filter Full Flow..... SFO 1705

A908
(EXCAVATORS)
Oil Filter Full Flow..... SFO 7124

A912 LITRONIC
(EXCAVATORS)
101
Fuel/Water Separator..... SFR 1212FW

A911
(EXCAVATORS)
DEUTZ F3L912
Fuel Filter..... SFF 0723
Oil Filter Full Flow..... SFO 4018

A911
(EXCAVATORS)
DEUTZ F4L912
Air Filter Primary..... SFA 1052PF
Fuel Filter..... SFF 0723
Hydraulic Oil Filter..... SFH 3490
Oil Filter Full Flow..... SFO 4018
Oil Filter Full Flow..... SFO 4054

A911C
(EXCAVATORS)
DEUTZ F5L912
Air Filter Primary..... SFA 1088P
Air Filter Secondary..... SFA 0800S
Fuel Filter..... SFF 0723
Fuel Filter..... SFF 3291
Hydraulic Oil Filter..... SFH 3490
Oil Filter Full Flow..... SFO 4054

A912
(EXCAVATORS)
DEUTZ F5/6L912
Air Filter Set..... SFA 1950SET
Air Filter Secondary..... SFA 0804S
Air Filter Primary..... SFA 0434PF
Air Filter Secondary..... SFA 4103S
Air Filter Set..... SFA 1733SET

A912
(EXCAVATORS)
DEUTZ F5/6L912
Air Filter Primary..... SFA 1733PF
Air Filter Set..... SFA 0434SET
Hydraulic Oil Filter..... SFH 3490
Oil Filter Full Flow..... SFO 4054

A912
(EXCAVATORS)
S/N: SR5094-UP
Air Filter Secondary..... SFA 5491S
Air Filter Primary..... SFA 7638PF
Coolant Filter..... SFW 2071
Oil Filter Full Flow..... SFO 4054

A921
(EXCAVATORS)
DEUTZ F4L912
Air Filter Primary..... SFA 1052PF
Fuel Filter..... SFF 0723
Oil Filter Full Flow..... SFO 4018

A921B
(EXCAVATORS)
DEUTZ F6L912
Air Filter Primary..... SFA 1733PF
Air Filter Secondary..... SFA 4103S
Air Filter Set..... SFA 1950SET
Air Filter Set..... SFA 1733SET
Fuel Filter..... SFF 0723
Fuel Filter..... SFF 3291
Hydraulic Oil Filter..... SFH 3490
Oil Filter Full Flow..... SFO 4054

A922
(EXCAVATORS)
Air Filter Secondary..... SFA 0804S
Air Filter Secondary..... SFA 9373S
Air Filter Primary..... SFA 0434PF
Air Filter Set..... SFA 0434SET
Fuel Filter..... SFF 3291
Oil Filter Full Flow..... SFO 9214
Oil Filter Full Flow..... SFO 4054
Oil Filter Full Flow..... SFO 9627

A922 LITRONIC
(EXCAVATORS)
, 1984-1998
Air Filter Primary..... SFA 1087P
Air Filter Secondary..... SFA 1200S
Coolant Filter..... SFW 2071
Fuel/Water Separator Secondary... SFR 2242FW
Fuel/Water Separator..... SFR 1212FW
Oil Filter Full Flow..... SFO 4054

A924
(EXCAVATORS)
Air Filter Primary..... SFA 1087P
Air Filter Secondary..... SFA 1200S
Coolant Filter..... SFW 2071
Oil Filter Full Flow..... SFO 4054

A924 LITRONIC
(EXCAVATORS)
LIEBHERR D924TE , 1998-UP
Air Filter Primary..... SFA 1087P
Air Filter Secondary..... SFA 1200S





Engine Application

MODEL/APPLICATION	SURE NO
LIEBHERR	
A924 LITRONIC (EXCAVATORS) LIEBHERR D924TE , 1998-UP	
Coolant Filter.....	SFW 2071
Oil Filter Full Flow.....	SFO 9627
A932 LITRONIC (EXCAVATORS) 517	
Coolant Filter.....	SFW 2072
Fuel/Water Separator.....	SFR 1212FW
A932 LITRONIC (EXCAVATORS) S/N: 5326-UP	
Air Filter Primary.....	SFA 1087P
Air Filter Secondary.....	SFA 1200S
Air Filter Primary.....	SFA 6501P
Air Filter Secondary.....	SFA 1300S
Coolant Filter.....	SFW 2072
Fuel/Water Separator.....	SFR 1212FW
Fuel/Water Separator Secondary....	SFR 2242FW
Oil Filter Full Flow.....	SFO 4054
A932 LITRONIC (EXCAVATORS) S/N: TO-0517	
Air Filter Primary.....	SFA 1087P
Air Filter Primary.....	SFA 6501P
Air Filter Secondary.....	SFA 1200S
Air Filter Secondary.....	SFA 1300S
Coolant Filter.....	SFW 2072
Fuel/Water Separator Secondary....	SFR 2242FW
Fuel/Water Separator.....	SFR 1212FW
Oil Filter Full Flow.....	SFO 4054
A932 LITRONIC (EXCAVATORS) S/N: TO-3036	
Air Filter Primary.....	SFA 1087P
Air Filter Primary.....	SFA 6501P
Air Filter Secondary.....	SFA 1200S
Air Filter Secondary.....	SFA 1300S
Coolant Filter.....	SFW 2072
Fuel/Water Separator.....	SFR 1212FW
Fuel/Water Separator Secondary....	SFR 2242FW
Oil Filter Full Flow.....	SFO 4054
A932 LITRONIC (EXCAVATORS) S/N: TO-4999	
Air Filter Secondary.....	SFA 1200S
Air Filter Primary.....	SFA 6501P
Air Filter Secondary.....	SFA 1300S
Air Filter Primary.....	SFA 1087P
Coolant Filter.....	SFW 2072
Fuel/Water Separator.....	SFR 1212FW
Fuel/Water Separator Secondary....	SFR 2242FW
Oil Filter Full Flow.....	SFO 4054
A932 LITRONIC (EXCAVATORS) S/N: TO-5325	
Air Filter Primary.....	SFA 6501P
Air Filter Primary.....	SFA 1087P
Air Filter Secondary.....	SFA 1200S
Air Filter Secondary.....	SFA 1300S
Coolant Filter.....	SFW 2072
Fuel/Water Separator.....	SFR 1212FW

MODEL/APPLICATION	SURE NO
LIEBHERR	
A932 LITRONIC (EXCAVATORS) S/N: TO-5325	
Fuel/Water Separator Secondary....	SFR 2242FW
Oil Filter Full Flow.....	SFO 4054
A932 (EXCAVATORS)	
Air Filter Primary.....	SFA 1087P
Air Filter Primary.....	SFA 6501P
Air Filter Secondary.....	SFA 1200S
Air Filter Secondary.....	SFA 1300S
Fuel Filter.....	SFF 3291
Oil Filter Full Flow.....	SFO 4054
A934B (EXCAVATORS) S/N: 5326-UP	
Air Filter Primary.....	SFA 6501P
Air Filter Secondary.....	SFA 1300S
Coolant Filter.....	SFW 2072
Fuel Filter.....	SFF 5427
Fuel/Water Separator Secondary....	SFR 2242FW
Oil Filter Full Flow.....	SFO 9627
Oil Filter Full Flow.....	SFO 4054
A934C (EXCAVATORS) LIEBHERR D934L , 2006-UP	
Fuel/Water Separator.....	SFR 4302FW
Fuel/Water Separator.....	SFR 90T1FWB
Fuel/Water Separator.....	SFR 90T1FW
Oil Filter Full Flow.....	SFO 1705
A942 (EXCAVATORS) DEUTZ , 1978-1987	
Air Filter Secondary.....	SFA 9373S
Fuel Filter.....	SFF 0723
Fuel Filter.....	SFF 3291
Oil Filter Full Flow.....	SFO 4054
Oil Filter Full Flow.....	SFO 9214
A944C (EXCAVATORS) LIEBHERR D 936 L , 2006-UP	
Fuel/Water Separator.....	SFR 90T1FWB
Fuel/Water Separator.....	SFR 4302FW
Fuel/Water Separator.....	SFR 90T1FW
Oil Filter Full Flow.....	SFO 1705
A954 (EXCAVATORS) LIEBHERR D926TI-E	
Hydraulic Oil Filter.....	SFH 4368
AK35 (CRANES) S/N: 12183-UP	
Fuel Filter.....	SFF 0453
AK40B (CRANES) S/N: 12183-UP	
Fuel Filter.....	SFF 0453
AK40V (CRANES) S/N: 12183-UP	
Fuel Filter Secondary.....	SFF 0404
HS830 (CRANES) LIEBHERR D906T , 1990-UP	

MODEL/APPLICATION	SURE NO
LIEBHERR	
HS830 (CRANES) LIEBHERR D906T , 1990-UP	
Oil Filter Full Flow.....	SFO 9627
HS840 (CRANES) LIEBHERR D906T , 1990-UP	
Oil Filter Full Flow.....	SFO 9627
HS840 (CRANES) MERCEDES OM422	
Fuel Filter Primary.....	SFF 3811
Oil Filter Full Flow.....	SFO 3327
HS841HD (CRANES) MERCEDES OM442A , 1995-UP	
Fuel Filter Primary.....	SFF 3811
Oil Filter Full Flow.....	SFO 3327
HS843HD (CRANES) LIEBHERR D9408TI , 1995-UP	
Oil Filter Full Flow.....	SFO 1705
HS843HD (CRANES) LIEBHERR D916TI , 1991-UP	
Oil Filter Full Flow.....	SFO 9627
HS853HD (CRANES) S/N: 80T-UP	
Air Filter Secondary.....	SFA 2073S
Air Filter Primary.....	SFA 2536P
Air Filter Set.....	SFA 2536SET
Oil Filter Full Flow.....	SFO 9627
HTM604 (MIXERS) DEUTZ	
Air Filter Primary.....	SFA 7250P
Air Filter Set.....	SFA 7250SET
L504 (LOADERS) S/N: 0501-UP	
Air Filter Set.....	SFA 7134SET
Air Filter Primary.....	SFA 7134P
Fuel Filter.....	SFF 7122
Oil Filter Full Flow.....	SFO 7195
Oil Filter Full Flow.....	SFO 7124
L504 (LOADERS) S/N: TO-0246	
Air Filter Primary.....	SFA 7134P
Air Filter Set.....	SFA 7134SET
Fuel Filter.....	SFF 7122
Oil Filter Full Flow.....	SFO 7124
Oil Filter Full Flow.....	SFO 7195
L506 (LOADERS) DEUTZ F4L1011 , 1989-UP	
Air Filter Primary.....	SFA 88891P
Air Filter Secondary.....	SFA 5485S
Air Filter Set.....	SFA 7134SET
Air Filter Primary.....	SFA 7134P
Air Filter Primary.....	SFA 77251P
Air Filter Primary.....	SFA 8889P
Air Filter Set.....	SFA 88891SET
Fuel Filter.....	SFF 7122



To order, please call:
+1 8448 BE SURE; +1 (925) 566-8863

For Reference Only - May not be a direct cross



Email :
order@suresfilter.us



Engine Application

MODEL/APPLICATION	SURE NO
LIEBHERR	

MODEL/APPLICATION	SURE NO
LIEBHERR	

MODEL/APPLICATION	SURE NO
LIEBHERR	

L506
(LOADERS)
DEUTZ F4L1011 , 1989-UP
Oil Filter Full Flow..... SFO 7195
Oil Filter Full Flow..... SFO 7124

L507
(LOADERS)
DEUTZ BF4L1011FT , 2000-UP
Air Filter Primary..... SFA 77251P
Air Filter Primary..... SFA 8889P
Air Filter Set..... SFA 88891SET
Air Filter Secondary..... SFA 5485S
Air Filter Primary..... SFA 88891P
Oil Filter Full Flow..... SFO 7124

L508 TYPE 232
(LOADERS)
DEUTZ F3L913
Air Filter Primary..... SFA 77251P
Air Filter Secondary..... SFA 4103S
Air Filter Secondary..... SFA 5485S
Air Filter Primary..... SFA 88891P
Air Filter Set..... SFA 88891SET
Air Filter Primary..... SFA 8889P
Fuel Filter..... SFF 7122
Fuel Filter..... SFF 0723
Hydraulic Oil Filter..... SFH 6359
Hydraulic Oil Filter..... SFH 7601
Oil Filter Full Flow..... SFO 4018
Oil Filter Full Flow..... SFO 7124
Oil Filter Full Flow..... SFO 7195

L509 TYPE 429
(LOADERS)
S/N: 2504-UP
Air Filter Primary..... SFA 8889P
Air Filter Primary..... SFA 77251P
Air Filter Set..... SFA 88891SET
Air Filter Primary..... SFA 88891P
Air Filter Secondary..... SFA 5485S
Oil Filter Full Flow..... SFO 7124
Oil Filter Full Flow..... SFO 7195

L509 TYPE 429
(LOADERS)
S/N: 2913-UP
Air Filter Secondary..... SFA 5485S
Air Filter Primary..... SFA 8889P
Air Filter Set..... SFA 88891SET
Air Filter Primary..... SFA 88891P
Air Filter Primary..... SFA 77251P
Oil Filter Full Flow..... SFO 7124
Oil Filter Full Flow..... SFO 7195

L509 TYPE 429
(LOADERS)
S/N: TO-0172
Air Filter Secondary..... SFA 5485S
Air Filter Set..... SFA 88891SET
Air Filter Primary..... SFA 8889P
Air Filter Primary..... SFA 88891P
Air Filter Primary..... SFA 77251P
Oil Filter Full Flow..... SFO 7124
Oil Filter Full Flow..... SFO 7195

L509 TYPE 779
(LOADERS)
S/N: 101-UP

L509 TYPE 779
(LOADERS)
S/N: 101-UP
Air Filter Primary..... SFA 77251P
Air Filter Secondary..... SFA 5485S
Air Filter Primary..... SFA 88891P
Air Filter Set..... SFA 88891SET
Air Filter Primary..... SFA 8889P

L500
(LOADERS)
L 538 (Type 433)
Oil Filter Full Flow..... SFO 7295
L500
(LOADERS)
L 542 (Type 435) Liebherr D934 S A6
Oil Filter Full Flow..... SFO 7295

L500
(LOADERS)
L 566 (Type 460)
Oil Filter Full Flow..... SFO 7295

L500
(LOADERS)
L 576 (Type 457) Liebherr D936L
Oil Filter Full Flow..... SFO 7295

L500
(LOADERS)
L 580 (Type 475 / 458 / 459) Liebherr D926TI
Oil Filter Full Flow..... SFO 7295

L500
(LOADERS)
L 586 (Type 461) LIEBHERR D936L A6
Oil Filter Full Flow..... SFO 7295

L510 TYPE 340
(LOADERS)
S/N: 0101-UP
Air Filter Primary..... SFA 8889P
Air Filter Secondary..... SFA 5485S
Air Filter Primary..... SFA 77251P
Air Filter Secondary..... SFA 4103S
Air Filter Set..... SFA 88891SET
Air Filter Primary..... SFA 88891P
Hydraulic Oil Filter..... SFH 6359
Oil Filter Full Flow..... SFO 4054

L511
(LOADERS)
LIEBHERR D904 NA
Oil Filter Full Flow..... SFO 9627

L511
(LOADERS)
S/N: 0101-UP
Air Filter Secondary..... SFA 4150S
Hydraulic Oil Filter..... SFH 6359
Oil Filter Full Flow..... SFO 4054

L512 TYPE 430
(LOADERS)
S/N: 0320-UP
Air Filter Primary..... SFA 1088P
Air Filter Secondary..... SFA 0800S
Oil Filter Full Flow..... SFO 4054

L512 TYPE 430
(LOADERS)
S/N: TO-0319
Air Filter Secondary..... SFA 0800S
Air Filter Primary..... SFA 1088P
Oil Filter Full Flow..... SFO 4054

L512 TYPE 466
(LOADERS)
S/N: 0101-UP , 2000-UP
Air Filter Primary..... SFA 7638PF
Air Filter Secondary..... SFA 5491S
Oil Filter Full Flow..... SFO 0754

L521
(LOADERS)
LIEBHERR D904 TB
Oil Filter Full Flow..... SFO 9627

L521
(LOADERS)
S/N: 0101-UP
Air Filter Secondary..... SFA 4150S
Hydraulic Oil Filter..... SFH 6359
Oil Filter Full Flow..... SFO 4054

L522
(LOADERS)
S/N: 0514-UP , 1991-UP
Air Filter Secondary..... SFA 0800S
Air Filter Primary..... SFA 1088P
Oil Filter Full Flow..... SFO 4054

L522
(LOADERS)
S/N: TO-0513 , 1991-UP
Air Filter Primary..... SFA 1088P
Air Filter Secondary..... SFA 0800S
Oil Filter Full Flow..... SFO 4054

L524 2PLUS1
(LOADERS)
LIEBHERR D934SAG , 2007-UP
Air Filter Primary..... SFA 78681PF
Air Filter Secondary..... SFA 7869S
Air Filter Primary..... SFA 7868PF
Air Filter Set..... SFA 7868SETF
Fuel/Water Separator..... SFR 90T1FW
Fuel/Water Separator..... SFR 90T1FWB
Fuel/Water Separator..... SFR 4302FW
Oil Filter Full Flow..... SFO 1705

L531
(LOADERS)
LIEBHERR LIEBHERR/ DEUTZ , 1986-UP
Air Filter Secondary..... SFA 4150S
Air Filter Secondary..... SFA 0678S
Coolant Filter..... SFW 2071
Coolant Filter..... SFW 2072
Hydraulic Oil Filter..... SFH 6359
Hydraulic Oil Filter..... SFH 3490
Oil Filter Full Flow..... SFO 9627
Oil Filter Full Flow..... SFO 4054
Oil Filter Full Flow..... SFO 9214

L534
(LOADERS)
S/N: 0101-UP , 2000-UP
Air Filter Primary..... SFA 0175P
Air Filter Secondary..... SFA 0176S
Oil Filter Full Flow..... SFO 0754

L534
(LOADERS)
S/N: 8962-UP , 2000-UP
Air Filter Secondary..... SFA 0176S
Air Filter Primary..... SFA 0175P
Oil Filter Full Flow..... SFO 0754



To order, please call:
+1 8448 BE SURE; +1 (925) 566-8863

For Reference Only - May not be a direct cross



Email :
order@suresfilter.us



Engine Application

MODEL/APPLICATION	SURE NO
LIEBHERR	

MODEL/APPLICATION	SURE NO
LIEBHERR	

MODEL/APPLICATION	SURE NO
LIEBHERR	

L538
(LOADERS)
S/N: 8508-UP
Air Filter Primary..... SFA 0175P
Air Filter Secondary..... SFA 0176S
Coolant Filter..... SFW 2071
Oil Filter Full Flow..... SFO 9627

L538
(LOADERS)
S/N: TO-8507
Air Filter Primary..... SFA 0175P
Air Filter Secondary..... SFA 0176S
Coolant Filter..... SFW 2071
Oil Filter Full Flow..... SFO 9627

L544 TYPE 442
(LOADERS)
Air Filter Set..... SFA 7868SETF
Air Filter Primary..... SFA 78681PF
Air Filter Secondary..... SFA 7869S
Air Filter Primary..... SFA 7868PF
Coolant Filter..... SFW 2072
Coolant Filter..... SFW 2071
Fuel Filter..... SFF 5427
Oil Filter Full Flow..... SFO 9627

L554
(LOADERS)
Air Filter Primary..... SFA 78681PF
Air Filter Set..... SFA 7868SETF
Air Filter Secondary..... SFA 7869S
Air Filter Primary..... SFA 7868PF
Coolant Filter..... SFW 2072
Fuel Filter..... SFF 5427
Oil Filter Full Flow..... SFO 9627

L551
(LOADERS)
LIEBHERR D906 TB , 1984-UP
Air Filter Primary..... SFA 2523P
Air Filter Secondary..... SFA 9373S
Air Filter Set..... SFA 2523SET
Coolant Filter..... SFW 2072
Hydraulic Oil Filter..... SFH 3490
Oil Filter Full Flow..... SFO 4054
Oil Filter Full Flow..... SFO 9627

L556 2PLUS2
(LOADERS)
LIEBHERR D934L , 2007-UP
Fuel/Water Separator..... SFR 4302FW

L564
(LOADERS)
LIEBHERR D926TI-E (S/N: 9077002-UP)
Air Filter Primary..... SFA 7868PF
Air Filter Set..... SFA 7868SETF
Air Filter Primary..... SFA 78681PF
Air Filter Secondary..... SFA 7869S
Coolant Filter..... SFW 2072
Fuel Filter..... SFF 5427
Oil Filter Full Flow..... SFO 9627

L574
(LOADERS)
Air Filter Secondary..... SFA 7869S

L574
(LOADERS)
Air Filter Primary..... SFA 78681PF
Air Filter Set..... SFA 7868SETF
Air Filter Primary..... SFA 7868PF
Coolant Filter..... SFW 2072
Fuel Filter..... SFF 5427
Oil Filter Full Flow..... SFO 9627

L574S
(LOADERS)
, 2002-UP
Air Filter Primary..... SFA 78681PF
Air Filter Secondary..... SFA 7869S
Air Filter Primary..... SFA 7868PF
Air Filter Set..... SFA 7868SETF
Coolant Filter..... SFW 2072
Oil Filter Full Flow..... SFO 9627

L576
(LOADERS)
LIEBHERR D 936 L
Air Filter Primary..... SFA 78681PF
Air Filter Secondary..... SFA 7869S
Air Filter Set..... SFA 7868SETF
Air Filter Primary..... SFA 7868PF
Fuel/Water Separator..... SFR 90T1FW
Fuel/Water Separator..... SFR 90T1FWB
Oil Filter Full Flow..... SFO 1705

L580
(LOADERS)
LIEBHERR D926TI-EA2
Air Filter Primary..... SFA 7868PF
Air Filter Set..... SFA 7868SETF
Air Filter Primary..... SFA 78681PF
Air Filter Secondary..... SFA 7869S
Coolant Filter..... SFW 2072
Fuel Filter..... SFF 5427
Oil Filter Full Flow..... SFO 9627

LG1130
(CRANES)
MERCEDES OM401
Air Filter Primary..... SFA 0123P
Air Filter Secondary..... SFA 1000S
Fuel Filter..... SFF 0860
Oil Filter Full Flow..... SFO 2110

LG1130
(CRANES)
MERCEDES OM404
Air Filter Primary..... SFA 1087P
Air Filter Secondary..... SFA 1200S
Fuel Filter..... SFF 0860
Oil Filter Full Flow..... SFO 3327

LG1140
(CRANES)
MERCEDES OM402
Air Filter Secondary..... SFA 1000S
Air Filter Primary..... SFA 0123P
Fuel Filter..... SFF 0860
Oil Filter Full Flow..... SFO 2110

LG1140
(CRANES)
MERCEDES OM404
Air Filter Secondary..... SFA 1200S

LG1140
(CRANES)
MERCEDES OM404
Air Filter Primary..... SFA 1087P
Fuel Filter..... SFF 0860
Oil Filter Full Flow..... SFO 3327

LG1250
(LOADERS)
LIEBHERR 12V-71T
Fuel Filter Primary..... SFF 6915
Fuel Filter Secondary..... SFF 6916
Oil Filter Full Flow..... SFO 0132

LG1250
(LOADERS)
MERCEDES OM403
Air Filter Secondary..... SFA 1000S
Air Filter Primary..... SFA 0123P
Fuel Filter Primary..... SFF 3811
Oil Filter Full Flow..... SFO 3327

LH843
(CRANES)
Hydraulic Oil Filter..... SFH 3884

LH853
(CRANES)
Hydraulic Oil Filter..... SFH 3884

LHM320
(CRANES)
S/N: 140366-UP
Air Filter Secondary..... SFA 1600S
Air Filter Primary..... SFA 1802P
Fuel/Water Separator..... SFR 0103FW

LHM 280
(CRANES)
LIEBHERR
Hydraulic Oil Filter..... SFH 6614

LHM 550
(CRANES)
LIEBHERR
Hydraulic Oil Filter..... SFH 6614

LI1010
(CRANES)
DEUTZ F3L912
Fuel Filter..... SFF 0723
Oil Filter Full Flow..... SFO 4018

LR
(DOZERS)
LR 624 Li Liebherr D 934 S , 2008
Oil Filter Full Flow..... SFO 7295

LR
(DOZERS)
LR 634 Li Liebherr D 934 L , 2008
Oil Filter Full Flow..... SFO 7295

LR
(DOZERS)
LR 634 Liebherr D934 L A6 , 2007
Oil Filter Full Flow..... SFO 7295

LR
(DOZERS)
LR 624 Liebherr D934S
Oil Filter Full Flow..... SFO 7295

LR1250
(LOADERS)
Air Filter Set..... SFA 7868SETF
Air Filter Primary..... SFA 7868PF



To order, please call:
+1 8448 BE SURE; +1 (925) 566-8863

For Reference Only - May not be a direct cross



Email :
order@suresfilter.us



Engine Application

MODEL/APPLICATION	SURE NO
LIEBHERR	

LR1250
(LOADERS)

Air Filter Primary..... SFA 78681PF
Oil Filter Full Flow..... SFO 4054

LR1400/2
(LOADERS)
S/N: 74292-UP , 2004-UP

Oil Filter Full Flow..... SFO 4054

LR611
(LOADERS)
S/N: 74292-UP , 1988-UP

Air Filter Secondary..... SFA 4150S
Air Filter Secondary..... SFA 4589S
Air Filter Primary..... SFA 4905P
Coolant Filter..... SFW 2072
Fuel Filter..... SFF 0402
Hydraulic Oil Filter Full Flow..... SFH 7243
Oil Filter Full Flow..... SFO 4054
Oil Filter Full Flow..... SFO 9471

LR621
(LOADERS)
, 1988-UP

Air Filter Secondary..... SFA 4150S
Air Filter Primary..... SFA 1735PF
Fuel Filter..... SFF 0402
Oil Filter Full Flow..... SFO 2107

LR621B
(LOADERS)
LIEBHERR MERCEDES/LIEBHERR

Air Filter Secondary..... SFA 4589S
Air Filter Secondary..... SFA 4150S
Air Filter Primary..... SFA 1735PF
Air Filter Primary..... SFA 4905P
Coolant Filter..... SFW 2072
Fuel Filter..... SFF 0402
Hydraulic Oil Filter Full Flow..... SFH 7243
Oil Filter Full Flow..... SFO 4054
Oil Filter Full Flow..... SFO 2107

LR622
(LOADERS)
S/N: 2201-UP

Air Filter Secondary..... SFA 4589S
Air Filter Secondary..... SFA 5491S
Air Filter Primary..... SFA 7638PF
Air Filter Primary..... SFA 4905P
Coolant Filter..... SFW 2072
Hydraulic Oil Filter..... SFH 0229
Oil Filter Full Flow..... SFO 9627

LR622
(LOADERS)
S/N: 5600-UP

Air Filter Secondary..... SFA 5491S
Air Filter Secondary..... SFA 4589S
Air Filter Primary..... SFA 4905P
Air Filter Primary..... SFA 7638PF
Coolant Filter..... SFW 2072
Hydraulic Oil Filter..... SFH 0229
Oil Filter Full Flow..... SFO 9627

LR622
(LOADERS)
S/N: TO-2029

Air Filter Primary..... SFA 4905P

MODEL/APPLICATION	SURE NO
LIEBHERR	

LR622
(LOADERS)
S/N: TO-2029

Air Filter Primary..... SFA 7638PF
Air Filter Secondary..... SFA 5491S
Air Filter Secondary..... SFA 4589S
Coolant Filter..... SFW 2072
Hydraulic Oil Filter..... SFH 0229
Oil Filter Full Flow..... SFO 9627

LR622
(LOADERS)
S/N: TO-2088

Air Filter Secondary..... SFA 4589S
Air Filter Primary..... SFA 4905P
Air Filter Primary..... SFA 7638PF
Air Filter Secondary..... SFA 5491S
Coolant Filter..... SFW 2072
Hydraulic Oil Filter..... SFH 0229
Oil Filter Full Flow..... SFO 9627

LR622
(LOADERS)
S/N: TO-2200

Air Filter Primary..... SFA 7638PF
Air Filter Secondary..... SFA 5491S
Air Filter Secondary..... SFA 4589S
Air Filter Primary..... SFA 4905P
Coolant Filter..... SFW 2072
Hydraulic Oil Filter..... SFH 0229
Oil Filter Full Flow..... SFO 9627

LR624 LITRONIC
(LOADERS)
LIEBHERR D934L , 2006-UP

Fuel/Water Separator..... SFR 4302FW
Fuel/Water Separator..... SFR 90T1FW
Fuel/Water Separator..... SFR 90T1FWB
Oil Filter Full Flow..... SFO 1705

LR631
(LOADERS)
MERCEDES OM401

Air Filter Secondary..... SFA 4103S
Air Filter Primary..... SFA 1733PF
Air Filter Set..... SFA 1733SET
Air Filter Set..... SFA 1950SET
Fuel Filter..... SFF 0453
Fuel Filter..... SFF 0402
Oil Filter Full Flow..... SFO 2110

LR631B
(LOADERS)

Air Filter Primary..... SFA 1090P
Air Filter Secondary..... SFA 0804S
Fuel Filter Secondary..... SFF 0404
Hydraulic Oil Filter..... SFH 0229
Oil Filter Full Flow..... SFO 3327

LR632
(LOADERS)
LIEBHERR D926TE

Air Filter Secondary..... SFA 0678S
Coolant Filter..... SFW 2073
Fuel Filter..... SFF 5427
Hydraulic Oil Filter..... SFH 0229
Oil Filter Full Flow..... SFO 9627

MODEL/APPLICATION	SURE NO
LIEBHERR	

LR641
(LOADERS)
, 1985-UP

Air Filter Secondary..... SFA 0678S
Fuel Filter Secondary..... SFF 0404
Hydraulic Oil Filter..... SFH 0229
Oil Filter Full Flow..... SFO 3327

LRB 355
(DRILLING)
LIEBHERR D 9512 , 2015

Hydraulic Oil Filter..... SFH 6614

LRB 355
(DRILLING)
LIEBHERR D 9512

Fuel Filter..... SFF 5090E

LRS 645
(REACH STACKER)
LIEBHERR D936 L A6

Hydraulic Oil Filter..... SFH 6614

LT1020
(CRANES)
MERCEDES OM355

Fuel Filter Primary..... SFF 3811
Oil Filter Full Flow..... SFO 1076

LT1020
(CRANES)
MERCEDES OM314

Air Filter Primary..... SFA 1089P
Fuel Filter..... SFF 0860
Fuel Filter Primary..... SFF 3811

LT1020
(CRANES)
MERCEDES OM36

Fuel Filter Primary..... SFF 3811
Oil Filter Full Flow..... SFO 1076

LT1025
(CRANES)
DEUTZ BF6L913

Air Filter Primary..... SFA 0123P
Air Filter Secondary..... SFA 1000S
Fuel Filter..... SFF 9405
Fuel Filter..... SFF 0723
Oil Filter Full Flow..... SFO 9214

LT1025
(CRANES)
DEUTZ F4L912

Fuel Filter..... SFF 0723
Oil Filter Full Flow..... SFO 4018

LT1025
(CRANES)
S/N: 4606959-UP

Air Filter Primary..... SFA 0123P
Air Filter Secondary..... SFA 1000S

LT1040
(CRANES)
MERCEDES OM402

Air Filter Primary..... SFA 6501P
Air Filter Secondary..... SFA 1300S
Fuel Filter..... SFF 0860
Oil Filter Full Flow..... SFO 2110

LT1040
(CRANES)
MERCEDES OM352A

Air Filter Primary..... SFA 1088P
Air Filter Secondary..... SFA 0800S
Fuel Filter..... SFF 0860



To order, please call:
+1 8448 BE SURE; +1 (925) 566-8863

For Reference Only - May not be a direct cross



Email :
order@suresfilter.us



Engine Application

MODEL/APPLICATION	SURE NO
LIEBHERR	

LT1040 (CRANES) MERCEDES OM352A	Oil Filter Full Flow..... SFO 2107
LT1045 (CRANES) MERCEDES OM352	Air Filter Primary..... SFA 1088P Air Filter Secondary..... SFA 0800S Fuel Filter..... SFF 0860 Oil Filter Full Flow..... SFO 1034
LT1045 (CRANES) MERCEDES OM403	Air Filter Primary..... SFA 6501P Air Filter Secondary..... SFA 1300S Fuel Filter Primary..... SFF 3811 Oil Filter Full Flow..... SFO 3327
LT1080 (CRANES) MERCEDES OM360	Air Filter Secondary..... SFA 1000S Air Filter Primary..... SFA 0123P Fuel Filter Primary..... SFF 3811 Fuel Filter..... SFF 0860 Hydraulic Oil Filter Transmission.. SFH 101X Oil Filter Full Flow..... SFO 1076
LT1080 (CRANES) MERCEDES OM404	Air Filter Primary..... SFA 1087P Air Filter Secondary..... SFA 1200S Fuel Filter..... SFF 0860 Oil Filter Full Flow..... SFO 3327
LT1100 (CRANES) DAIMLERB 130 HP	Air Filter Primary..... SFA 1087P Air Filter Secondary..... SFA 1200S Fuel Filter..... SFF 0402 Oil Filter Full Flow..... SFO 3327
LT1100 (CRANES) DAIMLERB 185 HP	Air Filter Secondary..... SFA 1200S Air Filter Primary..... SFA 1087P Fuel Filter..... SFF 0402 Oil Filter Full Flow..... SFO 3327
LTL1030 (CRANES)	Fuel Filter..... SFF 5427 Hydraulic Oil Filter..... SFH 1573 Oil Filter Full Flow..... SFO 9627 Oil Filter Full Flow..... SFO 8551E
LTM1030 (CRANES) MERCEDES OM402	Air Filter Secondary..... SFA 1000S Air Filter Primary..... SFA 0123P Fuel Filter..... SFF 0860 Hydraulic Oil Filter..... SFH 1534 Oil Filter Full Flow..... SFO 2110

MODEL/APPLICATION	SURE NO
LIEBHERR	

LTM1030/1 (CRANES) S/N: 0017793-UP	Air Filter Primary..... SFA 1802P Hydraulic Oil Filter Transmission... SFH 6837 Oil Filter Full Flow..... SFO 9627
LTM1030-2 (CRANES) OM906LA , 1998-UP	Hydraulic Oil Filter Transmission... SFH 6837 Oil Filter Full Flow..... SFO 8551E
LTM1030-2 (CRANES)	Hydraulic Oil Filter Transmission... SFH 4729 Oil Filter Full Flow..... SFO 8551E
LTM1030-2.1 (CRANES) S/N: Z17908-Z17918	Hydraulic Oil Filter Transmission... SFH 6837 Oil Filter Full Flow..... SFO 8551E
LTM1030-2.1 (CRANES) S/N: Z17919-Z18263	Hydraulic Oil Filter Transmission... SFH 6837 Oil Filter Full Flow..... SFO 8551E
LTM1030-2.1 (CRANES) S/N: Z18264-UP	Hydraulic Oil Filter Transmission... SFH 4729 Oil Filter Full Flow..... SFO 8551E
LTM1040 (CRANES) LIEBHERR D926TI	Air Filter Primary..... SFA 1802P Air Filter Secondary..... SFA 1600S Hydraulic Oil Filter Transmission... SFH 6837 Oil Filter Full Flow..... SFO 9627
LTM1040 (CRANES) MERCEDES OM442	Air Filter Primary..... SFA 6501P Air Filter Secondary..... SFA 1300S Fuel Filter Primary..... SFF 3811 Oil Filter Full Flow..... SFO 2110
LTM1040-1 (CRANES) S/N: 0019269-UP	Air Filter Primary..... SFA 1802P Coolant Filter..... SFW 2073 Fuel Filter Primary..... SFF 3811 Hydraulic Oil Filter Transmission... SFH 6837 Oil Filter Full Flow..... SFO 9627
LTM1045 (CRANES) MERCEDES OM422LA	Air Filter Primary..... SFA 1802P Air Filter Secondary..... SFA 1600S Fuel Filter Primary..... SFF 3811 Hydraulic Oil Filter Transmission... SFH 6837 Oil Filter Full Flow..... SFO 3327
LTM1045-1 (CRANES)	Coolant Filter..... SFW 2073

MODEL/APPLICATION	SURE NO
LIEBHERR	

LTM1045-1 (CRANES)	Fuel Filter..... SFF 5427 Fuel/Water Separator Secondary... SFR 2242FW Fuel/Water Separator..... SFR 1212FW Oil Filter Full Flow..... SFO 9627
LTM1050-1 (CRANES) LIEBHERR D926TI	Air Filter Primary..... SFA 1802P Air Filter Secondary..... SFA 1600S Hydraulic Oil Filter Transmission... SFH 6837 Oil Filter Full Flow..... SFO 9627
LTM1050-1 (CRANES) S/N: Z24000-Z24467	Air Filter Primary..... SFA 1802P Hydraulic Oil Filter Transmission... SFH 6837 Oil Filter Full Flow..... SFO 9627
LTM1050-1 (CRANES) S/N: Z24468-UP	Air Filter Primary..... SFA 1802P Coolant Filter..... SFW 2072 Hydraulic Oil Filter Transmission... SFH 6837 Oil Filter Full Flow..... SFO 9627
LTM1055 S/4 (CRANES) S/N: Z24468-UP , 1999-UP	Air Filter Primary..... SFA 0123P Hydraulic Oil Filter Transmission... SFH 101X Oil Filter Full Flow..... SFO 2107
LTM1055/1 (CRANES) LIEBHERR D926TI , 2000-UP	Coolant Filter..... SFW 2073 Fuel Filter..... SFF 5427 Fuel/Water Separator..... SFR 1212FW Fuel/Water Separator Secondary... SFR 2242FW Hydraulic Oil Filter..... SFH 1573 Oil Filter Full Flow..... SFO 9627
LTM1055-3.1 (CRANES) S/N: Z55200-UP	Coolant Filter..... SFW 2073 Fuel Filter..... SFF 5427 Fuel/Water Separator..... SFR 1212FW Fuel/Water Separator Secondary... SFR 2242FW Hydraulic Oil Filter..... SFH 0601 Hydraulic Oil Filter..... SFH 1573 Oil Filter Full Flow..... SFO 9627
LTM1060 (CRANES) MERCEDES OM352	Air Filter Primary..... SFA 1088P Air Filter Secondary..... SFA 0800S Fuel Filter Primary..... SFF 3811 Oil Filter Full Flow..... SFO 1034
LTM1060 (CRANES) MERCEDES OM403	Air Filter Secondary..... SFA 1300S Air Filter Primary..... SFA 6501P



Engine Application

MODEL/APPLICATION	SURE NO
LIEBHERR	

LTM1060
(CRANES)
MERCEDES OM403
Coolant Filter..... SFW 2075
Fuel Filter Primary..... SFF 3811
Oil Filter Full Flow..... SFO 3327

LTM1060/2
(CRANES)
S/N: Z57004-Z57431
Coolant Filter..... SFW 2072
Fuel/Water Separator Secondary... SFR 2242FW
Fuel/Water Separator..... SFR 1212FW
Hydraulic Oil Filter Transmission.. SFH 4729
Hydraulic Oil Filter..... SFH 1573
Hydraulic Oil Filter..... SFH 0601
Oil Filter Full Flow..... SFO 9627

LTM1060/2
(CRANES)
S/N: Z57432-UP
Coolant Filter..... SFW 2073
Fuel Filter..... SFF 5427
Fuel/Water Separator Secondary... SFR 2242FW
Fuel/Water Separator..... SFR 1212FW
Hydraulic Oil Filter Transmission.. SFH 4729
Hydraulic Oil Filter..... SFH 0601
Hydraulic Oil Filter..... SFH 1573
Oil Filter Full Flow..... SFO 9627

LTM1070/1
(CRANES)
S/N: 0022394-UP
Air Filter Primary..... SFA 1087P
Air Filter Primary..... SFA 1802P
Oil Filter Full Flow..... SFO 9627
Oil Filter Full Flow..... SFO 1705

LTM1080/1
(CRANES)
S/N: Z23801-Z25287
Air Filter Primary..... SFA 1802P
Coolant Filter..... SFW 2073
Fuel/Water Separator..... SFR 1212FW
Fuel/Water Separator Secondary... SFR 2242FW
Hydraulic Oil Filter..... SFH 0601
Hydraulic Oil Filter..... SFH 0962
Hydraulic Oil Filter..... SFH 1573
Oil Filter Full Flow..... SFO 9627

LTM1080/1
(CRANES)
S/N: Z61046-Z61269
Air Filter Primary..... SFA 1802P
Coolant Filter..... SFW 2073
Fuel/Water Separator..... SFR 1212FW
Fuel/Water Separator Secondary... SFR 2242FW
Hydraulic Oil Filter Transmission.. SFH 4729
Hydraulic Oil Filter..... SFH 0601
Hydraulic Oil Filter..... SFH 1573
Oil Filter Full Flow..... SFO 9627

LTM1080/1
(CRANES)
S/N: Z61270-UP
Coolant Filter..... SFW 2073
Fuel Filter..... SFF 5427
Fuel/Water Separator..... SFR 1212FW
Fuel/Water Separator Secondary... SFR 2242FW

MODEL/APPLICATION	SURE NO
LIEBHERR	

LTM1080/1
(CRANES)
S/N: Z61270-UP
Hydraulic Oil Filter Transmission... SFH 4729
Hydraulic Oil Filter..... SFH 0601
Hydraulic Oil Filter..... SFH 1573
Oil Filter Full Flow..... SFO 9627

LTM1090
(CRANES)
MERCEDES OM442
Air Filter Secondary..... SFA 1600S
Air Filter Primary..... SFA 1802P
Fuel Filter Primary..... SFF 3811
Hydraulic Oil Filter Transmission.. SFH 6389
Oil Filter Full Flow..... SFO 3327

LTM1090
(CRANES)
MERCEDES OM366
Air Filter Primary..... SFA 0123P
Air Filter Secondary..... SFA 1000S
Fuel Filter..... SFF 0860
Oil Filter Full Flow..... SFO 1034

LTM1090/1
(CRANES)
Air Filter Primary..... SFA 1802P
Air Filter Primary..... SFA 1087P
Oil Filter Full Flow..... SFO 9627

LTM1100/1
(CRANES)
S/N: 0022843-UP
Air Filter Primary..... SFA 0123P
Air Filter Primary..... SFA 1802P
Fuel Filter..... SFF 0860
Fuel Filter Primary..... SFF 3811
Oil Filter Full Flow..... SFO 3327
Oil Filter Full Flow..... SFO 9471

LTM1100-5.1
(CRANES)
S/N: Z65000-Z65159
Air Filter Primary..... SFA 9203P
Air Filter Set..... SFA 9203SET
Coolant Filter..... SFW 2073
Coolant Filter..... SFW 2072
Fuel Filter..... SFF 5427
Fuel/Water Separator..... SFR 1212FW
Fuel/Water Separator Secondary... SFR 2242FW
Hydraulic Oil Filter Transmission.. SFH 101X
Hydraulic Oil Filter..... SFH 0601
Oil Filter Full Flow..... SFO 9627
Oil Filter Full Flow..... SFO 1705

LTM1100-5.1
(CRANES)
S/N: Z65160-Z65215
Air Filter Set..... SFA 9203SET
Air Filter Primary..... SFA 9203P
Coolant Filter..... SFW 2073
Coolant Filter..... SFW 2072
Fuel Filter..... SFF 5427
Fuel/Water Separator Secondary... SFR 2242FW
Fuel/Water Separator..... SFR 1212FW
Hydraulic Oil Filter..... SFH 0601
Hydraulic Oil Filter Transmission.. SFH 101X

MODEL/APPLICATION	SURE NO
LIEBHERR	

LTM1100-5.1
(CRANES)
S/N: Z65160-Z65215
Oil Filter Full Flow..... SFO 1705
Oil Filter Full Flow..... SFO 9627

LTM1100-5.1
(CRANES)
S/N: Z65216-UP
Air Filter Set..... SFA 9203SET
Air Filter Primary..... SFA 9203P
Coolant Filter..... SFW 2072
Coolant Filter..... SFW 2073
Fuel Filter..... SFF 5427
Fuel/Water Separator Secondary... SFR 2242FW
Fuel/Water Separator..... SFR 1212FW
Hydraulic Oil Filter Transmission.. SFH 101X
Hydraulic Oil Filter..... SFH 0601
Oil Filter Full Flow..... SFO 1705
Oil Filter Full Flow..... SFO 9627

LTM1120/1
(CRANES)
LIEBHERR LOWER
Air Filter Primary..... SFA 1802P
Oil Filter Full Flow..... SFO 1705

LTM1120/1
(CRANES)
LIEBHERR UPPER
Air Filter Primary..... SFA 1087P
Coolant Filter..... SFW 2072
Oil Filter Full Flow..... SFO 9627

LTM1125
(CRANES)
MERCEDES OM362LA
Air Filter Primary..... SFA 0123P
Air Filter Secondary..... SFA 1000S
Fuel Filter Primary..... SFF 3811
Oil Filter Full Flow..... SFO 2110

LTM1160/1
(CRANES)
S/N: 0023289-UP
Air Filter Primary..... SFA 1087P
Air Filter Primary..... SFA 1802P
Oil Filter Full Flow..... SFO 1705
Oil Filter Full Flow..... SFO 9627

LTM1160/2
(CRANES)
LIEBHERR D9408TI , 1996-UP
Air Filter Primary..... SFA 1802P
Air Filter Primary..... SFA 1087P
Oil Filter Full Flow..... SFO 1705
Oil Filter Full Flow..... SFO 9627

LTM1160/2
(CRANES)
LIEBHERR D9408TI
Hydraulic Oil Filter..... SFH 6680

LTM1160/2
(CRANES)
S/N: Z22253-Z25003
Air Filter Primary..... SFA 1087P
Air Filter Primary..... SFA 1802P
Coolant Filter..... SFW 2072
Oil Filter Full Flow..... SFO 9627
Oil Filter Full Flow..... SFO 1705



Engine Application

MODEL/APPLICATION	SURE NO
LIEBHERR	

LTM1160/2
(CRANES)
S/N: Z25004-Z68077
Air Filter Primary..... SFA 1087P
Air Filter Primary..... SFA 1802P
Coolant Filter..... SFW 2072
Oil Filter Full Flow..... SFO 9627
Oil Filter Full Flow..... SFO 1705

LTM1200/1
(CRANES)
S/N: Z70086-UP
Air Filter Set..... SFA 9203SET
Air Filter Primary..... SFA 9203P
Coolant Filter..... SFW 2072
Coolant Filter..... SFW 2073
Fuel Filter..... SFF 5427
Fuel/Water Separator Secondary... SFR 2242FW
Fuel/Water Separator..... SFR 1212FW
Hydraulic Oil Filter Transmission.. SFH 101X
Oil Filter Full Flow..... SFO 9627
Oil Filter Full Flow..... SFO 1705

LTM1225
(CRANES)
LIEBHERR D9406
Air Filter Primary..... SFA 6501P
Fuel Filter..... SFF 3291
Oil Filter Full Flow..... SFO 1705

LTM1225
(CRANES)
S/N: 0022609-UP
Air Filter Primary..... SFA 6501P
Oil Filter Full Flow..... SFO 1705

LTM1250/1
(CRANES)
LIEBHERR D9408TI-E , 2001-UP
Air Filter Set..... SFA 9203SET
Air Filter Primary..... SFA 9203P
Oil Filter Full Flow..... SFO 9627
Oil Filter Full Flow..... SFO 1705

LTM1250-6.1
(CRANES)
Excluding S/N: Z70614
Air Filter Primary..... SFA 9203P
Air Filter Set..... SFA 9203SET
Coolant Filter..... SFW 2073
Fuel Filter..... SFF 5427
Fuel/Water Separator..... SFR 1212FW
Fuel/Water Separator Secondary... SFR 2242FW
Oil Filter Full Flow..... SFO 1705

LTM1250-6.1
(CRANES)
S/N: Z70500-UP
Coolant Filter..... SFW 2072
Fuel Filter..... SFF 5427
Fuel/Water Separator..... SFR 1212FW
Fuel/Water Separator Secondary... SFR 2242FW
Oil Filter Full Flow..... SFO 9627

LTM1250-6.1
(CRANES)
S/N: Z70500-Z70627
Air Filter Primary..... SFA 9203P
Air Filter Set..... SFA 9203SET
Coolant Filter..... SFW 2073

MODEL/APPLICATION	SURE NO
LIEBHERR	

LTM1250-6.1
(CRANES)
S/N: Z70500-Z70627
Fuel Filter..... SFF 5427
Fuel/Water Separator..... SFR 1212FW
Fuel/Water Separator Secondary... SFR 2242FW
Oil Filter Full Flow..... SFO 1705

LTM1250-6.1
(CRANES)
S/N: Z70628-AND Z70614
Fuel Filter..... SFF 5427
Fuel/Water Separator..... SFR 1212FW
Fuel/Water Separator Secondary... SFR 2242FW
Oil Filter Full Flow..... SFO 1705

LTM1300-6.1
(CRANES)
S/N: Z71002-Z71113
Air Filter Primary..... SFA 0500P
Air Filter Primary..... SFA 1802P
Coolant Filter..... SFW 2073
Coolant Filter..... SFW 2072
Fuel/Water Separator..... SFR 1212FW
Fuel/Water Separator Secondary... SFR 2242FW
Oil Filter Full Flow..... SFO 9627
Oil Filter Full Flow..... SFO 1705

LTM1400
(CRANES)
MERCEDES OM444A , 2003-UP
Air Filter Secondary..... SFA 2100S
Air Filter Primary..... SFA 9203P
Air Filter Set..... SFA 9203SET
Fuel Filter Primary..... SFF 3811
Oil Filter Full Flow..... SFO 3327

LTM1400-7.1
(CRANES)
S/N: Z72000-UP
Coolant Filter..... SFW 2073
Fuel Filter..... SFF 5427
Fuel/Water Separator..... SFR 1212FW
Fuel/Water Separator Secondary... SFR 2242FW
Hydraulic Oil Filter..... SFH 0601
Oil Filter Full Flow..... SFO 9627
Oil Filter Full Flow..... SFO 1705

LTM1500-8.1
(CRANES)
S/N: Z14477-Z73049
Air Filter Primary..... SFA 0500P
Air Filter Primary..... SFA 1802P
Coolant Filter..... SFW 2073
Fuel/Water Separator..... SFR 1212FW
Fuel/Water Separator Secondary... SFR 2242FW
Oil Filter Full Flow..... SFO 9627
Oil Filter Full Flow..... SFO 1705

LTM1500-8.1
(CRANES)
S/N: Z73050-UP
Air Filter Primary..... SFA 9203P
Air Filter Set..... SFA 9203SET
Air Filter Primary..... SFA 0500P
Coolant Filter..... SFW 2073
Fuel Filter..... SFF 5427
Fuel/Water Separator Secondary... SFR 2242FW
Fuel/Water Separator..... SFR 1212FW

MODEL/APPLICATION	SURE NO
LIEBHERR	

LTM1500-8.1
(CRANES)
S/N: Z73050-UP
Oil Filter Full Flow..... SFO 9627
Oil Filter Full Flow..... SFO 1705

LTM 1130/5.1
(MOBILE CRANES)
D846A7
Fuel Filter..... SFF 4474

MK100
(MOBILE CRANES)
D846TIA5 , 12800
Fuel Filter..... SFF 4474

MK100
(CRANES)
S/N: Z77250-UP , 2004-UP
Fuel Filter..... SFF 5672E
Hydraulic Oil Filter Transmission.. SFH 101X

MK80
(CRANES)
S/N: Z77060-UP , 2002-UP
Coolant Filter..... SFW 2073
Fuel Filter..... SFF 5427
Fuel/Water Separator Secondary... SFR 2242FW
Fuel/Water Separator..... SFR 1212FW
Oil Filter Full Flow..... SFO 9627

PR
(DOZERS)
744 Liebherr D936 L A6 , 2006
Oil Filter Full Flow..... SFO 7295

PR
(DOZERS)
754 Liebherr D946 L A6 , 2006
Oil Filter Full Flow..... SFO 7295

PR
(DOZERS)
711/M Mercedes OM 352
Air Filter Secondary..... SFA 4103S
Air Filter Primary..... SFA 1733PF
Fuel Filter..... SFF 900X
Hydraulic Oil Filter..... SFH 2910
Oil Filter Full Flow..... SFO 9471E

PR
(DOZERS)
731 Mercedes-Benz OM401
Air Filter Primary..... SFA 1090P
Air Filter Secondary..... SFA 0804S
Fuel Filter..... SFF 900X
Hydraulic Oil Filter..... SFH 0229
Oil Filter Full Flow..... SFO 3327

PR
(DOZERS)
731/C/CL/CM DB OM 421
Air Filter Primary..... SFA 1733PF
Air Filter Secondary..... SFA 4103S
Fuel Filter..... SFF 900X
Hydraulic Oil Filter..... SFH 0229
Oil Filter Full Flow..... SFO 2110

PR
(DOZERS)
734 L / XL / LGP D926 TI-E
Oil Filter Full Flow..... SFO 7295

PR
(DOZERS)
741/B/C DB OM 402/421 A
Fuel Filter..... SFF 900X



To order, please call:
+1 8448 BE SURE; +1 (925) 566-8863

For Reference Only - May not be a direct cross



Email :
order@suresfilter.us



Engine Application

MODEL/APPLICATION	SURE NO
LIEBHERR	

PR
(DOZERS)
741/B/C DB OM 402/421 A
Hydraulic Oil Filter..... SFH 0229
Oil Filter Full Flow..... SFO 3327

PR
(DOZERS)
752 D9406 TI-E
Oil Filter Full Flow..... SFO 7295

PR724L
(TRACTORS)
LIEBHERR D934LA6
Air Filter Set..... SFA 7406SET
Air Filter Secondary..... SFA 7154S
Air Filter Primary..... SFA 7406P

PR724LGB
(TRACTORS)
LIEBHERR D934LA6
Air Filter Primary..... SFA 7406P
Air Filter Set..... SFA 7406SET
Air Filter Secondary..... SFA 7154S

PR724XL
(DOZERS)
, 2006-UP
Air Filter Secondary..... SFA 0678S
Coolant Filter..... SFW 2073
Fuel Filter..... SFF 5427
Oil Filter Full Flow..... SFO 9627

PR724XL
(DOZERS)
LIEBHERR D934LA6
Air Filter Primary..... SFA 7406P
Air Filter Set..... SFA 7406SET
Air Filter Secondary..... SFA 7154S

PR711
(DOZERS)
Air Filter Secondary..... SFA 4150S
Fuel Filter..... SFF 0402
Hydraulic Oil Filter Full Flow..... SFH 7243
Oil Filter Full Flow..... SFO 9471

PR712
(DOZERS)
Air Filter Secondary..... SFA 5491S
Air Filter Primary..... SFA 7638PF
Air Filter Secondary..... SFA 4589S
Air Filter Primary..... SFA 4905P
Coolant Filter..... SFW 2072
Fuel Filter..... SFF 5427
Hydraulic Oil Filter..... SFH 0229
Oil Filter Full Flow..... SFO 9627

PR712 LITRONIC
(DOZERS)
LIEBHERR MERCEDES/LIEBHERR , 1988-UP
Air Filter Secondary..... SFA 4589S
Air Filter Primary..... SFA 4905P
Hydraulic Oil Filter..... SFH 0962
Oil Filter Full Flow..... SFO 9627

PR721
(DOZERS)
MERCEDES OM352
Air Filter Secondary..... SFA 4103S
Fuel Filter Secondary..... SFF 0404

MODEL/APPLICATION	SURE NO
LIEBHERR	

PR721
(DOZERS)
MERCEDES OM352
Fuel Filter Primary..... SFF 3811

PR721BM
(DOZERS)
LIEBHERR D94/6 , 1990-UP
Air Filter Secondary..... SFA 4103S
Fuel Filter..... SFF 0860
Fuel Filter Primary..... SFF 3811
Oil Filter Full Flow..... SFO 9471
Oil Filter Full Flow..... SFO 9627

PR721BM
(DOZERS)
MERCEDES OM352 , 1990-UP
Air Filter Secondary..... SFA 4103S
Fuel Filter..... SFF 0860
Fuel Filter Primary..... SFF 3811
Oil Filter Full Flow..... SFO 9627
Oil Filter Full Flow..... SFO 9471

PR721C
(DOZERS)
, 1988-UP
Air Filter Primary..... SFA 4905P
Air Filter Secondary..... SFA 5491S
Air Filter Primary..... SFA 7638PF
Air Filter Secondary..... SFA 4150S
Air Filter Secondary..... SFA 4589S
Coolant Filter..... SFW 2072
Fuel Filter..... SFF 0860
Fuel Filter..... SFF 0402
Fuel Filter..... SFF 5427
Hydraulic Oil Filter..... SFH 0229
Hydraulic Oil Filter Full Flow..... SFH 7243
Oil Filter Full Flow..... SFO 2107
Oil Filter Full Flow..... SFO 9627
Oil Filter Full Flow..... SFO 4054

PR722 LITRONIC
(DOZERS)
Air Filter Secondary..... SFA 4589S
Air Filter Primary..... SFA 4905P
Hydraulic Oil Filter..... SFH 0962
Oil Filter Full Flow..... SFO 9627

PR731
(DOZERS)
LIEBHERR D94/6
Air Filter Primary..... SFA 1733PF
Air Filter Set..... SFA 1950SET
Air Filter Set..... SFA 1733SET
Air Filter Secondary..... SFA 4103S
Fuel Filter..... SFF 0402
Fuel Filter..... SFF 0860
Fuel Filter Primary..... SFF 3811
Hydraulic Oil Filter..... SFH 0962
Oil Filter Full Flow..... SFO 2110
Oil Filter Full Flow..... SFO 9627

PR731
(DOZERS)
MERCEDES OM401
Air Filter Primary..... SFA 1733PF
Air Filter Secondary..... SFA 4103S
Air Filter Set..... SFA 1733SET

MODEL/APPLICATION	SURE NO
LIEBHERR	

PR731
(DOZERS)
MERCEDES OM401
Air Filter Set..... SFA 1950SET
Fuel Filter..... SFF 0860
Fuel Filter..... SFF 0402
Fuel Filter Primary..... SFF 3811
Hydraulic Oil Filter..... SFH 0962
Oil Filter Full Flow..... SFO 9627
Oil Filter Full Flow..... SFO 2110

PR731C
(DOZERS)
LIEBHERR MERCEDES/LIEBHERR
Air Filter Primary..... SFA 1090P
Air Filter Secondary..... SFA 0804S
Fuel Filter Secondary..... SFF 0404
Hydraulic Oil Filter..... SFH 0229
Oil Filter Full Flow..... SFO 3327

PR732
(DOZERS)
, 1990-UP
Air Filter Secondary..... SFA 0678S
Coolant Filter..... SFW 2073
Fuel Filter..... SFF 5427
Hydraulic Oil Filter..... SFH 0229
Oil Filter Full Flow..... SFO 9627

PR734 LITRONIC
(DOZERS)
Air Filter Secondary..... SFA 0678S
Coolant Filter..... SFW 2073
Fuel Filter..... SFF 5427
Oil Filter Full Flow..... SFO 9627

PR741
(DOZERS)
MERCEDES OM402
Air Filter Set..... SFA 1733SET
Air Filter Primary..... SFA 1733PF
Air Filter Secondary..... SFA 4103S
Air Filter Set..... SFA 1950SET
Fuel Filter..... SFF 0402
Oil Filter Full Flow..... SFO 3327
Oil Filter Full Flow..... SFO 2110

PR741C
(DOZERS)
Air Filter Primary..... SFA 1091P
Air Filter Secondary..... SFA 0772S
Fuel Filter Secondary..... SFF 0404
Hydraulic Oil Filter..... SFH 0229
Oil Filter Full Flow..... SFO 3327

PR742
(DOZERS)
, 1991-UP
Air Filter Secondary..... SFA 0678S
Coolant Filter..... SFW 2073
Fuel Filter..... SFF 5427
Hydraulic Oil Filter..... SFH 0229
Oil Filter Full Flow..... SFO 9627

PR751
(DOZERS)
CUMMINS KT-1150
Air Filter Secondary..... SFA 0804S



To order, please call:
+1 8448 BE SURE; +1 (925) 566-8863

For Reference Only - May not be a direct cross



Email :
order@surefilter.us



Engine Application

MODEL/APPLICATION	SURE NO
LIEBHERR	

MODEL/APPLICATION	SURE NO
LIEBHERR	

MODEL/APPLICATION	SURE NO
LIEBHERR	

PR751
(DOZERS)
CUMMINS KT-1150
Air Filter Primary..... SFA 1090P
Coolant Filter..... SFW 2071
Fuel Filter Secondary..... SFF 0404
Fuel/Water Separator..... SFR 1212FW
Fuel/Water Separator Secondary... SFR 2242FW
Hydraulic Oil Filter..... SFH 0229
Oil Filter Full Flow..... SFO 2670
Oil Filter Full Flow..... SFO 4054
Oil Filter By Pass..... SFO 2777

PR752
(DOZERS)
Air Filter Primary..... SFA 0731P
Air Filter Set..... SFA 0731SET
Coolant Filter..... SFW 2073
Fuel Filter..... SFF 5427
Oil Filter Full Flow..... SFO 1705

PR754
(DOZERS)
Air Filter Secondary..... SFA 1399S
Air Filter Primary..... SFA 0731P
Air Filter Primary..... SFA 1398P
Air Filter Set..... SFA 1398SET
Air Filter Set..... SFA 0731SET
Coolant Filter..... SFW 2073
Fuel Filter..... SFF 5427
Fuel/Water Separator..... SFR 4302FW
Fuel/Water Separator..... SFR 90T1FWB
Fuel/Water Separator..... SFR 90T1FW
Oil Filter Full Flow..... SFO 1705

PR744
(DOZERS)
LIEBHERR D936 L A6 , 2006
Air Filter Secondary..... SFA 9773S

R310
(EXCAVATORS)
Air Filter Secondary..... SFA F700S
Air Filter Primary..... SFA 1089P
Oil Filter Full Flow..... SFO 7195

R317 LITRONIC
(EXCAVATORS)
DEUTZ BF4M1013EC , 2001-UP
Air Filter Primary..... SFA 0500P
Coolant Filter..... SFW 4685
Fuel Filter..... SFF 1723
Oil Filter Full Flow..... SFO 4054

R902 LITRONIC
(EXCAVATORS)
101
Coolant Filter..... SFW 2071
Fuel/Water Separator..... SFR 1212FW

R902 LITRONIC
(EXCAVATORS)
S/N: 0101-UP
Air Filter Primary..... SFA 0123P
Air Filter Secondary..... SFA 1000S
Coolant Filter..... SFW 2071
Fuel/Water Separator..... SFR 1212FW

R902 LITRONIC
(EXCAVATORS)
S/N: 0101-UP
Fuel/Water Separator Secondary... SFR 2242FW
Oil Filter Full Flow..... SFO 9627

R902 LITRONIC
(EXCAVATORS)
S/N: 2901-UP
Air Filter Secondary..... SFA 1000S
Air Filter Primary..... SFA 0123P
Coolant Filter..... SFW 2071
Fuel/Water Separator..... SFR 1212FW
Fuel/Water Separator Secondary... SFR 2242FW
Oil Filter Full Flow..... SFO 9627

R902 LITRONIC
(EXCAVATORS)
S/N: 3131-UP
Air Filter Secondary..... SFA 1000S
Air Filter Primary..... SFA 0123P
Coolant Filter..... SFW 2071
Fuel/Water Separator..... SFR 1212FW
Fuel/Water Separator Secondary... SFR 2242FW
Oil Filter Full Flow..... SFO 9627

R902 LITRONIC
(EXCAVATORS)
S/N: 4000-UP
Air Filter Secondary..... SFA 1000S
Air Filter Primary..... SFA 0123P
Coolant Filter..... SFW 2071
Fuel/Water Separator..... SFR 1212FW
Fuel/Water Separator Secondary... SFR 2242FW
Oil Filter Full Flow..... SFO 9627

R900B LITRONIC
(EXCAVATORS)
Air Filter Primary..... SFA 0123P
Air Filter Secondary..... SFA 1000S
Coolant Filter..... SFW 4685
Fuel Filter..... SFF 1723
Fuel Filter..... SFF 0006
Oil Filter Full Flow..... SFO 4054

R900C LITRONIC
(EXCAVATORS)
LIEBHERR , 2004-UP
Air Filter Secondary..... SFA 5491S
Air Filter Primary..... SFA 7638PF
Coolant Filter..... SFW 2071
Fuel Filter..... SFF 5427
Fuel/Water Separator Secondary... SFR 2242FW
Oil Filter Full Flow..... SFO 9627

R904
(EXCAVATORS)
S/N: 6296-UP
Air Filter Primary..... SFA 0123P
Air Filter Primary..... SFA 7638PF
Air Filter Secondary..... SFA 5491S
Air Filter Secondary..... SFA 1000S
Coolant Filter..... SFW 2071
Oil Filter Full Flow..... SFO 9627

R904
(EXCAVATORS)
S/N: 8709-UP
Air Filter Primary..... SFA 7638PF

R904
(EXCAVATORS)
S/N: 8709-UP
Air Filter Secondary..... SFA 1000S
Air Filter Primary..... SFA 0123P
Air Filter Secondary..... SFA 5491S
Coolant Filter..... SFW 2071
Oil Filter Full Flow..... SFO 9627

R904
(EXCAVATORS)
S/N: T0-6295
Air Filter Primary..... SFA 0123P
Air Filter Secondary..... SFA 5491S
Air Filter Primary..... SFA 7638PF
Air Filter Secondary..... SFA 1000S
Coolant Filter..... SFW 2071
Oil Filter Full Flow..... SFO 9627

R912 LITRONIC
(EXCAVATORS)
101
Coolant Filter..... SFW 2071
Fuel/Water Separator..... SFR 1212FW

R912 LITRONIC
(EXCAVATORS)
S/N: 0101-UP
Air Filter Secondary..... SFA 1000S
Air Filter Primary..... SFA 0123P
Air Filter Secondary..... SFA 5491S
Air Filter Primary..... SFA 7638PF
Coolant Filter..... SFW 2071
Fuel/Water Separator..... SFR 1212FW
Fuel/Water Separator Secondary... SFR 2242FW
Oil Filter Full Flow..... SFO 4054

R912 LITRONIC
(EXCAVATORS)
S/N: 2628-UP
Air Filter Secondary..... SFA 1000S
Air Filter Secondary..... SFA 5491S
Air Filter Primary..... SFA 0123P
Air Filter Primary..... SFA 7638PF
Coolant Filter..... SFW 2071
Fuel/Water Separator Secondary... SFR 2242FW
Fuel/Water Separator..... SFR 1212FW
Oil Filter Full Flow..... SFO 4054

R912 LITRONIC
(EXCAVATORS)
S/N: 3388-UP
Air Filter Secondary..... SFA 1000S
Air Filter Secondary..... SFA 5491S
Air Filter Primary..... SFA 0123P
Air Filter Primary..... SFA 7638PF
Coolant Filter..... SFW 2071
Fuel/Water Separator Secondary... SFR 2242FW
Fuel/Water Separator..... SFR 1212FW
Oil Filter Full Flow..... SFO 4054

R912 LITRONIC
(EXCAVATORS)
S/N: 4000-UP
Air Filter Primary..... SFA 7638PF
Air Filter Secondary..... SFA 5491S
Air Filter Secondary..... SFA 1000S
Air Filter Primary..... SFA 0123P
Coolant Filter..... SFW 2071



Engine Application

MODEL/APPLICATION	SURE NO
LIEBHERR	

R912 LITRONIC
(EXCAVATORS)
S/N: 4000-UP
Fuel/Water Separator..... SFR 1212FW
Fuel/Water Separator Secondary... SFR 2242FW
Oil Filter Full Flow..... SFO 4054

R912
(EXCAVATORS)
LIEBHERR D904 NA
Air Filter Primary..... SFA 0418P
Air Filter Secondary..... SFA 0490S
Hydraulic Oil Filter..... SFH 3490
Oil Filter Full Flow..... SFO 4054
Oil Filter Full Flow..... SFO 9627

R914
(EXCAVATORS)
S/N: 6000-UP
Air Filter Secondary..... SFA 1200S
Air Filter Primary..... SFA 1087P
Air Filter Primary..... SFA 7638PF
Air Filter Secondary..... SFA 5491S
Coolant Filter..... SFW 2071
Oil Filter Full Flow..... SFO 4054
Oil Filter Full Flow..... SFO 9627

R914
(EXCAVATORS)
S/N: 8713-UP
Air Filter Primary..... SFA 7638PF
Air Filter Secondary..... SFA 1200S
Air Filter Secondary..... SFA 5491S
Air Filter Primary..... SFA 1087P
Coolant Filter..... SFW 2071
Oil Filter Full Flow..... SFO 4054
Oil Filter Full Flow..... SFO 9627

R914 LITRONIC
(EXCAVATORS)
LIEBHERR D924TE
Oil Filter Full Flow..... SFO 9627

R914B
(EXCAVATORS)
Air Filter Primary..... SFA 6501P
Air Filter Secondary..... SFA 1300S
Coolant Filter..... SFW 2072
Fuel Filter..... SFF 5427
Fuel/Water Separator Secondary... SFR 2242FW
Oil Filter Full Flow..... SFO 9627

R914HD/SL LITRONIC
(EXCAVATORS)
Oil Filter Full Flow..... SFO 9627

R9150
(EXCAVATORS)
LIEBHERR D 9512
Fuel Filter..... SFF 4060E

R922 LITRONIC
(EXCAVATORS)
101
Coolant Filter..... SFW 2071
Fuel/Water Separator..... SFR 1212FW

R922 LITRONIC
(EXCAVATORS)
345
Fuel/Water Separator..... SFR 1212FW

MODEL/APPLICATION	SURE NO
LIEBHERR	

R922 LITRONIC
(EXCAVATORS)
S/N: 0101-UP
Air Filter Primary..... SFA 1087P
Air Filter Secondary..... SFA 1200S
Coolant Filter..... SFW 2071
Fuel/Water Separator..... SFR 1212FW
Fuel/Water Separator Secondary... SFR 2242FW
Oil Filter Full Flow..... SFO 4054

R922 LITRONIC
(EXCAVATORS)
S/N: 0345-UP
Air Filter Primary..... SFA 1087P
Air Filter Secondary..... SFA 1200S
Coolant Filter..... SFW 2071
Fuel/Water Separator..... SFR 1212FW
Fuel/Water Separator Secondary... SFR 2242FW
Oil Filter Full Flow..... SFO 4054

R922 LITRONIC
(EXCAVATORS)
S/N: 3527-UP
Air Filter Primary..... SFA 1087P
Air Filter Secondary..... SFA 1200S
Coolant Filter..... SFW 2071
Fuel/Water Separator..... SFR 1212FW
Fuel/Water Separator Secondary... SFR 2242FW
Oil Filter Full Flow..... SFO 4054

R922 LITRONIC
(EXCAVATORS)
S/N: 4000-UP
Air Filter Secondary..... SFA 1200S
Air Filter Primary..... SFA 1087P
Coolant Filter..... SFW 2071
Fuel/Water Separator Secondary... SFR 2242FW
Fuel/Water Separator..... SFR 1212FW
Oil Filter Full Flow..... SFO 4054

R922
(EXCAVATORS)
LIEBHERR D906 NA
Air Filter Secondary..... SFA 9373S
Oil Filter Full Flow..... SFO 4054
Oil Filter Full Flow..... SFO 9214
Oil Filter Full Flow..... SFO 9627

R922LC
(EXCAVATORS)
DEUTZ F6L912
Air Filter Set..... SFA 0434SET
Air Filter Secondary..... SFA 0804S
Air Filter Primary..... SFA 0434PF
Fuel Filter..... SFF 3291
Oil Filter Full Flow..... SFO 4054

R924
(EXCAVATORS)
S/N: 6000-UP
Air Filter Primary..... SFA 1087P
Air Filter Secondary..... SFA 1200S
Coolant Filter..... SFW 2071
Oil Filter Full Flow..... SFO 4054
Oil Filter Full Flow..... SFO 9627

R924B
(EXCAVATORS)
LIEBHERR , 2004-UP
Air Filter Secondary..... SFA 1300S

MODEL/APPLICATION	SURE NO
LIEBHERR	

R924B
(EXCAVATORS)
LIEBHERR , 2004-UP
Air Filter Primary..... SFA 6501P
Coolant Filter..... SFW 2072
Fuel Filter..... SFF 5427
Fuel/Water Separator Secondary... SFR 2242FW
Oil Filter Full Flow..... SFO 9627

R925
(EXCAVATORS)
Air Filter Secondary..... SFA 0804S
Air Filter Set..... SFA 0434SET
Air Filter Primary..... SFA 0434PF
Fuel Filter..... SFF 0723
Hydraulic Oil Filter..... SFH 3055
Oil Filter Full Flow..... SFO 4054

R932
(EXCAVATORS)
DEUTZ BF6L913
Air Filter Primary..... SFA 0123P
Air Filter Secondary..... SFA 1000S
Oil Filter Full Flow..... SFO 9214

R932 LITRONIC
(EXCAVATORS)
LIEBHERR D914
Air Filter Secondary..... SFA 1300S
Air Filter Primary..... SFA 6501P
Air Filter Secondary..... SFA 1200S
Air Filter Primary..... SFA 1087P
Coolant Filter..... SFW 2072
Fuel/Water Separator..... SFR 1212FW
Fuel/Water Separator Secondary... SFR 2242FW
Oil Filter Full Flow..... SFO 4054

R934
(EXCAVATORS)
LIEBHERR D924TI-E
Air Filter Secondary..... SFA 1300S
Air Filter Primary..... SFA 6501P
Fuel/Water Separator Secondary... SFR 2242FW
Oil Filter Full Flow..... SFO 4054

R934
(EXCAVATORS)
S/N: 5000-UP
Air Filter Secondary..... SFA 1300S
Air Filter Primary..... SFA 6501P
Coolant Filter..... SFW 2072
Fuel/Water Separator Secondary... SFR 2242FW
Oil Filter Full Flow..... SFO 4054

R934
(EXCAVATORS)
S/N: 5278-UP
Air Filter Primary..... SFA 6501P
Air Filter Secondary..... SFA 1300S
Coolant Filter..... SFW 2072
Fuel/Water Separator Secondary... SFR 2242FW
Oil Filter Full Flow..... SFO 4054

R942 LITRONIC
(EXCAVATORS)
101
Coolant Filter..... SFW 2072

R942 LITRONIC
(EXCAVATORS)
475



Engine Application

MODEL/APPLICATION	SURE NO
LIEBHERR	

R942 LITRONIC
(EXCAVATORS)
475
Coolant Filter..... SFW 2072
Fuel/Water Separator..... SFR 1212FW

R942 LITRONIC
(EXCAVATORS)
S/N: 0101-UP
Air Filter Secondary..... SFA 1300S
Air Filter Primary..... SFA 6501P
Coolant Filter..... SFW 2072
Fuel Filter..... SFF 3291
Fuel/Water Separator..... SFR 1212FW
Fuel/Water Separator Secondary... SFR 2242FW
Oil Filter Full Flow..... SFO 4054

R942 LITRONIC
(EXCAVATORS)
S/N: 0475-UP
Air Filter Secondary..... SFA 1300S
Air Filter Primary..... SFA 6501P
Coolant Filter..... SFW 2072
Fuel Filter..... SFF 3291
Fuel/Water Separator Secondary... SFR 2242FW
Fuel/Water Separator..... SFR 1212FW
Oil Filter Full Flow..... SFO 4054

R942 LITRONIC
(EXCAVATORS)
S/N: 3077-UP
Air Filter Secondary..... SFA 1300S
Air Filter Primary..... SFA 6501P
Coolant Filter..... SFW 2072
Fuel Filter..... SFF 3291
Fuel/Water Separator..... SFR 1212FW
Fuel/Water Separator Secondary... SFR 2242FW
Oil Filter Full Flow..... SFO 4054

R942 LITRONIC
(EXCAVATORS)
S/N: 4000-UP
Air Filter Secondary..... SFA 1300S
Air Filter Primary..... SFA 6501P
Coolant Filter..... SFW 2072
Fuel Filter..... SFF 3291
Fuel/Water Separator..... SFR 1212FW
Fuel/Water Separator Secondary... SFR 2242FW
Oil Filter Full Flow..... SFO 4054

R 944 C
(EXCAVATORS)
LIEBHERR D 936 L
Fuel/Water Separator..... SFR 44301FW

R941
(EXCAVATORS)
DEUTZ F6L912
Fuel Filter..... SFF 0723
Oil Filter Full Flow..... SFO 4054

R941B
(EXCAVATORS)
DEUTZ BF6L912
Air Filter Secondary..... SFA 4150S
Air Filter Primary..... SFA 1735PF
Fuel Filter..... SFF 0723
Oil Filter Full Flow..... SFO 4054

R941B
(EXCAVATORS)
DEUTZ BF6L913C

MODEL/APPLICATION	SURE NO
LIEBHERR	

R941B
(EXCAVATORS)
DEUTZ BF6L913C
Air Filter Secondary..... SFA 1000S
Air Filter Primary..... SFA 0123P
Fuel Filter..... SFF 0723
Oil Filter Full Flow..... SFO 9214
Oil Filter Full Flow..... SFO 4054

R942
(EXCAVATORS)
DEUTZ BF6L913B
Air Filter Secondary..... SFA 9373S
Fuel Filter..... SFF 0723
Fuel Filter..... SFF 3291
Oil Filter Full Flow..... SFO 4054
Oil Filter Full Flow..... SFO 9214

R942
(EXCAVATORS)
LIEBHERR D906T
Air Filter Secondary..... SFA 9373S
Fuel Filter..... SFF 3291
Oil Filter Full Flow..... SFO 4054

R942
(EXCAVATORS)
LIEBHERR GM
Air Filter Secondary..... SFA 9373S
Fuel Filter..... SFF 5220
Fuel Filter Secondary..... SFF 0511
Oil Filter Full Flow..... SFO 0947
Oil Filter Full Flow..... SFO 0132

R942HD
(EXCAVATORS)
DEUTZ BF6L913B
Air Filter Secondary..... SFA 9373S
Fuel Filter..... SFF 3291
Oil Filter Full Flow..... SFO 9214

R942LC
(EXCAVATORS)
DEUTZ
Air Filter Secondary..... SFA 9373S
Fuel Filter..... SFF 3291
Oil Filter Full Flow..... SFO 9214

R944B HD-S
(EXCAVATORS)
S/N: WLHZ0650PZC013990-UP , 2004-UP
Air Filter Secondary..... SFA 1300S
Air Filter Primary..... SFA 6501P
Coolant Filter..... SFW 2072
Fuel Filter..... SFF 5427
Fuel/Water Separator Secondary... SFR 2242FW
Oil Filter Full Flow..... SFO 9627

R945
(EXCAVATORS)
S/N: WLHZ0650PZC013990-UP
Air Filter Set..... SFA 0434SET
Air Filter Primary..... SFA 0434PF
Air Filter Secondary..... SFA 0804S
Fuel Filter..... SFF 0723
Oil Filter Full Flow..... SFO 9214

R945B
(EXCAVATORS)
S/N: WLHZ0650PZC013990-UP
Air Filter Secondary..... SFA 0490S
Fuel Filter..... SFF 0723

MODEL/APPLICATION	SURE NO
LIEBHERR	

R945B
(EXCAVATORS)
S/N: WLHZ0650PZC013990-UP
Oil Filter Full Flow..... SFO 9214

R 946
(EXCAVATORS)
LIEBHERR D936A7 , 2012
Air Filter Primary..... SFA 3108P
Air Filter Set..... SFA 3108SET
Air Filter Secondary..... SFA 3109S

R954
(EXCAVATORS)
313
Air Filter Secondary..... SFA 2100S
Fuel/Water Separator..... SFR 1212FW

R954
(EXCAVATORS)
384
Air Filter Secondary..... SFA 2100S
Fuel/Water Separator..... SFR 1212FW

R954
(EXCAVATORS)
LIEBHERR D926TI-E
Hydraulic Oil Filter..... SFH 4368

R954
(EXCAVATORS)
S/N: 1000-UP
Air Filter Set..... SFA 9203SET
Air Filter Primary..... SFA 7868PF
Air Filter Primary..... SFA 78681PF
Air Filter Primary..... SFA 9203P
Air Filter Secondary..... SFA 7869S
Air Filter Set..... SFA 7868SETF
Air Filter Secondary..... SFA 2100S
Coolant Filter..... SFW 2073
Fuel Filter..... SFF 5427
Fuel/Water Separator..... SFR 1212FW
Fuel/Water Separator Secondary... SFR 2242FW
Hydraulic Oil Filter..... SFH 0229
Oil Filter Full Flow..... SFO 4054
Oil Filter Full Flow..... SFO 9627

R954
(EXCAVATORS)
S/N: 385-443
Air Filter Primary..... SFA 9203P
Air Filter Secondary..... SFA 7869S
Air Filter Set..... SFA 7868SETF
Air Filter Primary..... SFA 7868PF
Air Filter Secondary..... SFA 2100S
Air Filter Primary..... SFA 78681PF
Air Filter Set..... SFA 9203SET
Coolant Filter..... SFW 2073
Fuel Filter..... SFF 5427
Fuel/Water Separator Secondary... SFR 2242FW
Fuel/Water Separator..... SFR 1212FW
Hydraulic Oil Filter..... SFH 0229
Oil Filter Full Flow..... SFO 9627
Oil Filter Full Flow..... SFO 4054

R954
(EXCAVATORS)
S/N: 444-990
Air Filter Primary..... SFA 9203P
Air Filter Secondary..... SFA 7869S



To order, please call:
+1 8448 BE SURE; +1 (925) 566-8863

For Reference Only - May not be a direct cross



Email :
order@suresfilter.us



Engine Application

MODEL/APPLICATION	SURE NO
LIEBHERR	

MODEL/APPLICATION	SURE NO
LIEBHERR	

MODEL/APPLICATION	SURE NO
LIEBHERR	

R954
(EXCAVATORS)
S/N: 444-990
Air Filter Set..... SFA 7868SETF
Air Filter Primary..... SFA 7868PF
Air Filter Secondary..... SFA 2100S
Air Filter Primary..... SFA 78681PF
Air Filter Set..... SFA 9203SET
Coolant Filter..... SFW 2073
Fuel Filter..... SFF 5427
Fuel/Water Separator Secondary... SFR 2242FW
Fuel/Water Separator..... SFR 1212FW
Hydraulic Oil Filter..... SFH 0229
Oil Filter Full Flow..... SFO 9627
Oil Filter Full Flow..... SFO 4054

R954
(EXCAVATORS)
S/N: TO-0313
Air Filter Primary..... SFA 9203P
Air Filter Secondary..... SFA 2100S
Air Filter Set..... SFA 9203SET
Fuel/Water Separator Secondary... SFR 2242FW
Fuel/Water Separator..... SFR 1212FW
Hydraulic Oil Filter..... SFH 0229
Oil Filter Full Flow..... SFO 4054

R954
(EXCAVATORS)
S/N: TO-0384
Air Filter Secondary..... SFA 2100S
Air Filter Primary..... SFA 9203P
Air Filter Set..... SFA 9203SET
Fuel/Water Separator..... SFR 1212FW
Fuel/Water Separator Secondary... SFR 2242FW
Hydraulic Oil Filter..... SFH 0229
Oil Filter Full Flow..... SFO 4054

R954B
(EXCAVATORS)
LIEBHERR D926TI-E
Hydraulic Oil Filter..... SFH 4368

R 954 C
(EXCAVATORS)
LIEBHERR D936 , 2006-UP
Air Filter Set..... SFA 7871SET
Air Filter Primary..... SFA 7871P
Air Filter Secondary..... SFA 7875S
Fuel/Water Separator..... SFR 90T1FWB
Fuel/Water Separator..... SFR 4302FW
Fuel/Water Separator..... SFR 90T1FW
Hydraulic Oil Filter..... SFH 7524
Oil Filter Full Flow..... SFO 1705

R 954 C
(EXCAVATORS)
LIEBHERR D 936 L
Fuel/Water Separator..... SFR 44301FW

R952
(EXCAVATORS)
CUMMINS L10
Air Filter Primary..... SFA 1002P
Air Filter Secondary..... SFA 9372S
Coolant Filter..... SFW 2071
Fuel Filter..... SFF 0105D
Fuel Filter..... SFF 105DN
Fuel/Water Separator..... SFR 1212FW

R952
(EXCAVATORS)
CUMMINS L10
Oil Filter Combination..... SFO 2300
Oil Filter Full Flow..... SFO 2670
Oil Filter By Pass..... SFO 2777

R954 LITRONIC
(EXCAVATORS)
S/N: 1000-UP
Fuel/Water Separator..... SFR 90T1FWB
Fuel/Water Separator..... SFR 90T1FW

R964
(EXCAVATORS)
144
Fuel/Water Separator..... SFR 1212FW

R964
(EXCAVATORS)
168
Coolant Filter..... SFW 2073
Fuel/Water Separator..... SFR 1212FW

R964
(EXCAVATORS)
224
Coolant Filter..... SFW 2073
Fuel/Water Separator..... SFR 1212FW

R964
(EXCAVATORS)
S/N: TO-0144
Air Filter Secondary..... SFA 9373S
Coolant Filter..... SFW 2073
Fuel/Water Separator Secondary... SFR 2242FW
Fuel/Water Separator..... SFR 1212FW
Hydraulic Oil Filter..... SFH 0229
Oil Filter Full Flow..... SFO 4054

R964
(EXCAVATORS)
S/N: TO-0168
Air Filter Secondary..... SFA 9373S
Coolant Filter..... SFW 2073
Fuel/Water Separator Secondary... SFR 2242FW
Fuel/Water Separator..... SFR 1212FW
Hydraulic Oil Filter..... SFH 0229
Oil Filter Full Flow..... SFO 4054

R964
(EXCAVATORS)
S/N: TO-0224
Air Filter Secondary..... SFA 9373S
Coolant Filter..... SFW 2073
Fuel/Water Separator Secondary... SFR 2242FW
Fuel/Water Separator..... SFR 1212FW
Hydraulic Oil Filter..... SFH 0229
Oil Filter Full Flow..... SFO 4054

R964LI
(EXCAVATORS)
0225-4999
Coolant Filter..... SFW 2073
Fuel/Water Separator..... SFR 1212FW

R964LI
(EXCAVATORS)
S/N: 0225-4999
Air Filter Secondary..... SFA 9373S
Coolant Filter..... SFW 2073
Fuel/Water Separator Secondary... SFR 2242FW
Fuel/Water Separator..... SFR 1212FW

R964LI
(EXCAVATORS)
S/N: 0225-4999
Oil Filter Full Flow..... SFO 4054

R961
(EXCAVATORS)
DEUTZ F6L413
Air Filter Secondary..... SFA 4103S
Air Filter Primary..... SFA 1054PF
Air Filter Primary..... SFA 1054P
Air Filter Set..... SFA 1054PSET
Fuel Filter..... SFF 0723
Oil Filter Full Flow..... SFO 0950

R961
(EXCAVATORS)
DEUTZ F8L413
Air Filter Primary..... SFA 1054P
Air Filter Primary..... SFA 1054PF
Air Filter Set..... SFA 1054PSET
Fuel Filter..... SFF 0723
Oil Filter Full Flow..... SFO 0950

R961B
(EXCAVATORS)
DEUTZ F8L413
Fuel Filter..... SFF 9405
Oil Filter Full Flow..... SFO 0950
Oil Filter Full Flow..... SFO 4054

R962
(EXCAVATORS)
CUMMINS NTT-855C
Air Filter Primary..... SFA 7435P
Air Filter Secondary..... SFA 9370S
Air Filter Set..... SFA 0851SET
Air Filter Primary..... SFA 0851P
Air Filter Secondary..... SFA 0883S
Coolant Filter..... SFW 2071
Fuel Filter..... SFF 0105D
Fuel Filter..... SFF 105DN
Fuel/Water Separator..... SFR 1212FW
Fuel/Water Separator Secondary... SFR 2242FW
Hydraulic Oil Filter..... SFH 0962
Oil Filter By Pass..... SFO 2777
Oil Filter By Pass..... SFO 5050
Oil Filter Full Flow..... SFO 2670
Oil Filter Full Flow..... SFO 0516

R965B
(EXCAVATORS)
S/N: 0225-4999
Air Filter Set..... SFA 0434SET
Air Filter Secondary..... SFA 0804S
Air Filter Primary..... SFA 0434PF
Fuel Filter..... SFF 9405
Oil Filter Full Flow..... SFO 0950
Oil Filter Full Flow..... SFO 4054

R974B 1206
(EXCAVATORS)
CUMMINS NTA-855
Hydraulic Oil Filter..... SFH 4368

R974B 1207
(EXCAVATORS)
CUMMINS NTA-855
Hydraulic Oil Filter..... SFH 4368





Engine Application

MODEL/APPLICATION	SURE NO
LIEBHERR	
R974B-9079 (EXCAVATORS) CUMMINS NTA-855	
Hydraulic Oil Filter.....	SFH 4368
R974B-LITRONIC (EXCAVATORS) LIEBHERR D9408TI	
Air Filter Secondary.....	SFA 9370S
Air Filter Primary.....	SFA 7435P
Fuel/Water Separator Secondary...	SFR 2242FW
Hydraulic Oil Filter.....	SFH 4368
Oil Filter Full Flow.....	SFO 4054
R974-LITRONIC 0990 (EXCAVATORS) CUMMINS NTA-855	
Hydraulic Oil Filter.....	SFH 4368
R971 (EXCAVATORS) DEUTZ F8L413	
Air Filter Set.....	SFA 1733SET
Air Filter Secondary.....	SFA 4103S
Air Filter Set.....	SFA 1054PSET
Air Filter Primary.....	SFA 1054P
Air Filter Primary.....	SFA 1733PF
Air Filter Set.....	SFA 1950SET
Air Filter Primary.....	SFA 1054PF
Fuel Filter.....	SFF 0723
Oil Filter Full Flow.....	SFO 0950
R972HD (EXCAVATORS) CUMMINS NTA-855	
Air Filter Secondary.....	SFA 0883S
Coolant Filter.....	SFW 2071
Fuel Filter.....	SFF 105DN
Fuel Filter.....	SFF 0105D
Hydraulic Oil Filter.....	SFH 0962
Oil Filter Full Flow.....	SFO 0516
Oil Filter By Pass.....	SFO 2777
Oil Filter By Pass.....	SFO 5050
Oil Filter Full Flow.....	SFO 2670
R974 LITRONIC (EXCAVATORS) CUMMINS NTA-855	
Air Filter Secondary.....	SFA 0883S
Air Filter Primary.....	SFA 0851P
Air Filter Set.....	SFA 0851SET
Air Filter Secondary.....	SFA 9370S
Coolant Filter.....	SFW 2071
Coolant Filter.....	SFW 2073
Fuel/Water Separator Secondary...	SFR 2242FW
Fuel/Water Separator.....	SFR 1212FW
Hydraulic Oil Filter.....	SFH 0962
Hydraulic Oil Filter.....	SFH 0229
Oil Filter By Pass.....	SFO 2777
Oil Filter Full Flow.....	SFO 2670
Oil Filter Full Flow.....	SFO 4054
R972 (EXCAVATORS) CUMMINS NTT-855C	

MODEL/APPLICATION	SURE NO
LIEBHERR	
R972 (EXCAVATORS) CUMMINS NTT-855C	
Fuel Filter.....	SFF 105DN
R 976 (EXCAVATORS) LIEBHERR D9508A7SCR , 2013	
Air Filter Secondary.....	SFA 3109S
Air Filter Primary.....	SFA 3108P
Air Filter Set.....	SFA 3108SET
R984 LITRONIC (EXCAVATORS) 990	
Coolant Filter.....	SFW 2071
Coolant Filter.....	SFW 2076
Fuel/Water Separator.....	SFR 1212FW
R984 LITRONIC (EXCAVATORS) S/N: T0-0990	
Air Filter Secondary.....	SFA 8408S
Air Filter Primary.....	SFA 1042P
Air Filter Secondary.....	SFA 7781S
Coolant Filter.....	SFW 2071
Coolant Filter.....	SFW 2076
Fuel/Water Separator.....	SFR 1212FW
Fuel/Water Separator.....	SFR 5110FW
Fuel/Water Separator Secondary...	SFR 2242FW
Hydraulic Oil Filter.....	SFH 3884
Hydraulic Oil Filter.....	SFH 0229
Oil Filter Full Flow.....	SFO 2670
Oil Filter By Pass.....	SFO 2777
Oil Filter Combination.....	SFO 2300
R981 (EXCAVATORS) DEUTZ BF6L913	
Air Filter Primary.....	SFA 0123P
Air Filter Secondary.....	SFA 1000S
Fuel Filter.....	SFF 0723
Oil Filter Full Flow.....	SFO 9214
R981 (EXCAVATORS)	
Fuel Filter.....	SFF 0723
Fuel Filter.....	SFF 3291
Oil Filter Full Flow.....	SFO 9214
R982 (EXCAVATORS) CUMMINS NTA-855	
Air Filter Primary.....	SFA 0851P
Air Filter Set.....	SFA 0851SET
Air Filter Secondary.....	SFA 0883S
Coolant Filter.....	SFW 2071
Fuel Filter.....	SFF 0105D
Fuel Filter.....	SFF 105DN
Fuel/Water Separator Secondary...	SFR 2242FW
Fuel/Water Separator.....	SFR 1212FW
Hydraulic Oil Filter.....	SFH 0962
Oil Filter Full Flow.....	SFO 0516
Oil Filter By Pass.....	SFO 2777
Oil Filter By Pass.....	SFO 5050
Oil Filter Full Flow.....	SFO 2670

MODEL/APPLICATION	SURE NO
LIEBHERR	
R982 (EXCAVATORS) CUMMINS NTT-855C	
Fuel Filter.....	SFF 105DN
R982HD (EXCAVATORS) CUMMINS NTT-855C	
Fuel Filter.....	SFF 105DN
R982HD (EXCAVATORS)	
Fuel Filter.....	SFF 105N
Hydraulic Oil Filter.....	SFH 0962
Hydraulic Oil Filter.....	SFH 3884
Oil Filter By Pass.....	SFO 5565
R982GD (EXCAVATORS) CUMMINS NTA-855	
Fuel Filter.....	SFF 105DN
R982LC (EXCAVATORS) CUMMINS NTT-855C	
Fuel Filter.....	SFF 105DN
R984 Li (EXCAVATORS) CUMMINS KTA-19C	
Fuel Filter.....	SFF 105DN
R994 (EXCAVATORS) CUMMINS	
Coolant Filter.....	SFW 2071
Oil Filter Full Flow.....	SFO 2670
R994 LITRONIC (EXCAVATORS) CUMMINS KTA-38C	
Fuel/Water Separator.....	SFR 1216FW
Oil Filter Full Flow.....	SFO 2670
Oil Filter By Pass.....	SFO 5565
R991 (EXCAVATORS) CUMMINS NTA-855	
Fuel Filter.....	SFF 105DN
R/A 300 (EXCAVATORS) DEUTZ TCD2012L042V A 312 LITRONIC (TYPE 1037) ,	
Fuel Filter.....	SFF 3045
R/A 300 (EXCAVATORS) DEUTZ TCD2012 L04 A 309 (TYPE 1035) , 2009	
Fuel Filter.....	SFF 3045
R/A 300 (EXCAVATORS) DEUTZ TCD2012 L04 A 311 (TYPE 1036) , 2009	
Fuel Filter.....	SFF 3045
R/A 300 (EXCAVATORS) DEUTZ TCD2013 L4-2V TIER 3 A 314 (TYPE 1039) ,	
Fuel Filter.....	SFF 3045
R/A 300 (EXCAVATORS) DEUTZ TCD2013 L4-2V TIER 3 A 316 (TYPE 1040 &	
Fuel Filter.....	SFF 3045
R/A 300 (EXCAVATORS) DEUTZ TCD 2012 L04 R 313 LITRONIC (TYPE 636 &	
Fuel Filter.....	SFF 3045



Engine Application

MODEL/APPLICATION	SURE NO
LIEBHERR	

R/A 300
 (EXCAVATORS)
 DEUTZ BF4M 1013EC A 316 LITRONIC , 2001
 Fuel Filter..... SFF 3045

R/A 300
 (EXCAVATORS)
 A 314 LITRONIC (TYPE 1039 / 1350)
 Fuel Filter..... SFF 3045

R/A 300
 (EXCAVATORS)
 R 313 (TYPE 1038)
 Fuel Filter..... SFF 3045

RST961
 (EXCAVATORS)
 Fuel Filter Secondary..... SFF 0404

TL435-10 LITRONIC
 (FORKLIFTS)
 JDEERE 4045 , 2007
 Air Filter Primary..... SFA 5479P
 Air Filter Secondary..... SFA 5480S
 Air Filter Set..... SFA 5479SET

TL435-10 LITRONIC
 (FORKLIFTS)
 LIEBHERR D504TI , 2007
 Air Filter Primary..... SFA 5479P
 Air Filter Set..... SFA 5479SET
 Air Filter Secondary..... SFA 5480S

TL435-13 LITRONIC
 (FORKLIFTS)
 JDEERE 4045 , 2007
 Air Filter Secondary..... SFA 5480S
 Air Filter Set..... SFA 5479SET
 Air Filter Primary..... SFA 5479P

TL435-13 LITRONIC
 (FORKLIFTS)
 LIEBHERR D504TI , 2007
 Air Filter Secondary..... SFA 5480S
 Air Filter Set..... SFA 5479SET
 Air Filter Primary..... SFA 5479P

TL441-13 LITRONIC
 (FORKLIFTS)
 JDEERE 4045HF287 , 2012
 Air Filter Secondary..... SFA 5480S
 Air Filter Set..... SFA 5479SET
 Air Filter Primary..... SFA 5479P

TL445-10 LITRONIC
 (FORKLIFTS)
 JDEERE 4045 , 2007
 Air Filter Secondary..... SFA 5480S
 Air Filter Primary..... SFA 5479P
 Air Filter Set..... SFA 5479SET

TL445-10 LITRONIC
 (FORKLIFTS)
 LIEBHERR D504TI , 2007
 Air Filter Secondary..... SFA 5480S
 Air Filter Set..... SFA 5479SET
 Air Filter Primary..... SFA 5479P



PRODUCT GUIDE

B



Product Guide

SFA 0123P Air Filter Primary Metal End Cap Element

MERCEDES-BENZ 001 094 42 04
IVECO 2165049



Secondary Filter uses SFA 1000S
Set Filter uses SFA 0123SET

H 1 : 375 (mm)
H 2 : 362 (mm)
OD 1 : 197.5 (mm)
OD 2 : 197.5 (mm)
ID 1 : 103.5 (mm)
ID 2 : 9 (mm)

CONT : 6
VOL : 0.110

SFA 0434SET Air Filter Set Metal End Cap Element With Sleeve

FIAT 1930751+1930790
KOMATSU 6131-82-7011
FIAT 70684732+1930790
JOHN DEERE T46316+T46317



Primary Filter uses SFA 0434PF
Secondary Filter uses SFA 0804S

H 1 : 419 (mm)
H 2 : 406 (mm)
OD 1 : 254 (mm)
OD 2 : 201.5 (mm)
ID 1 : 135.5 (mm)
ID 2 : 17 (mm)

CONT : 4
VOL : 0.134

SFA 0731SET Air Filter Set Metal End Cap Element

RENAULT 5 010 064 371+5 010 064 372



Primary Filter uses SFA 0731P
Secondary Filter uses SFA 0372S

H 1 : 398 (mm)
H 2 : 385 (mm)
OD 1 : 307 (mm)
OD 2 : 307 (mm)
ID 1 : 196 (mm)
ID 2 : 17 (mm)

CONT : 1
VOL : 0.046

SFA 0175P Air Filter Primary Soft PU end cap Element

VOLVO 11110175
J.C.BAMFORD 32/925404
RENAULT 7700050840



Secondary Filter uses SFA 0176S

H 1 : 473 (mm)
H 2 : 460 (mm)
OD 1 : 237 (mm)
OD 2 : 237 (mm)
ID 1 : 132 (mm)

CONT : 4
VOL : 0.133

SFA 0490S Air Filter Secondary Metal End Cap Element

ISUZU 1-14215047-0
ISUZU 1-1425-046-1
NISSAN 16546-96010



Primary Filter uses SFA 3113P
Set Filter uses SFA 6050SET

H 1 : 330 (mm)
OD 1 : 146 (mm)
OD 2 : 116.5 (mm)
ID 1 : 88 (mm)
ID 2 : 17 (mm)

CONT : 9
VOL : 0.085

SFA 0772S Air Filter Secondary Metal End Cap Element

JOHN DEERE AR-70107



Primary Filter uses SFA 1091P
Set Filter uses SFA 1091SET

H 1 : 467 (mm)
H 2 : 457 (mm)
OD 1 : 151 (mm)
OD 2 : 151 (mm)
ID 1 : 123 (mm)
ID 2 : 17 (mm)

CONT : 9
VOL : 0.125

SFA 0176S Air Filter Secondary Soft PU end cap Element

VOLVO 11110176
J.C.BAMFORD 32/925405



Primary Filter uses SFA 0175P

H 1 : 454 (mm)
H 2 : 448 (mm)
OD 1 : 134 (mm)
OD 2 : 125 (mm)
ID 1 : 95.5 (mm)

CONT : 9
VOL : 0.093

SFA 0500P Air Filter Primary Soft PU end cap Element

VOLVO 2908237
MASSEY-FERGUSON 3901477M1
J.C.BAMFORD 580-12020



Secondary Filter uses SFA 1500S
Set Filter uses SFA 0500SET

H 1 : 400 (mm)
H 2 : 367 (mm)
OD 1 : 194 (mm)
OD 2 : 194 (mm)
ID 1 : 113.5 (mm)

CONT : 4
VOL : 0.076

SFA 0800S Air Filter Secondary Aluminium casting end cap, Element

DEUTZ 2985037
VOLVO 4765611



Primary Filter uses SFA 1088P
Set Filter uses SFA 1088SET

H 1 : 346 (mm)
OD 1 : 90 (mm)
OD 2 : 82 (mm)
ID 1 : 71 (mm)
ID 2 : 17 (mm)

CONT : 25
VOL : 0.091

SFA 0418P Air Filter Primary Metal End Cap Element

FIAT 0068473-3
ISUZU 1-14215-018-0
ISUZU 1-14215007-0
NISSAN 16546-96011



Secondary Filter uses SFA 0490S
Set Filter uses SFA 6029SET

H 1 : 343 (mm)
H 2 : 330 (mm)
OD 1 : 234 (mm)
OD 2 : 234 (mm)
ID 1 : 123 (mm)
ID 2 : 17 (mm)

CONT : 4
VOL : 0.098

SFA 0678S Air Filter Secondary Metal End Cap Element

MASSEY-FERGUSON 3580724M1
LIEBHERR 7403951
JOHN DEERE RE42762



Primary Filter uses SFA 1531PF
Set Filter uses SFA 1531SET

H 1 : 394 (mm)
H 2 : 381 (mm)
OD 1 : 151 (mm)
OD 2 : 151 (mm)
ID 1 : 123 (mm)
ID 2 : 17 (mm)

CONT : 9
VOL : 0.103

SFA 0804S Air Filter Secondary Metal End Cap Element

NISSAN 16546-96004
KOBELCO 2451U180-3B
KOBELCO 2451U206-3
KOMATSU 600-181-8360
ISUZU 9-14215017-0



Primary Filter uses SFA 0434PF
Set Filter uses SFA 0434SET

H 1 : 397 (mm)
H 2 : 397 (mm)
OD 1 : 146 (mm)
OD 2 : 116.5 (mm)
ID 1 : 88 (mm)
ID 2 : 17 (mm)

CONT : 9
VOL : 0.103

SFA 0434PF Air Filter Primary Metal End Cap Element With Sleeve

NISSAN 16546-96003
NISSAN 16546-96015
NISSAN 16546-96026



Secondary Filter uses SFA 0804S
Set Filter uses SFA 0434SET

H 1 : 419 (mm)
H 2 : 406 (mm)
OD 1 : 254 (mm)
OD 2 : 201.5 (mm)
ID 1 : 135.5 (mm)
ID 2 : 17 (mm)

CONT : 1
VOL : 0.031

SFA 0731P Air Filter Primary Metal End Cap Element

RENAULT 5 010 064 371



Secondary Filter uses SFA 0372S
Set Filter uses SFA 0731SET

H 1 : 398 (mm)
H 2 : 385 (mm)
OD 1 : 307 (mm)
OD 2 : 307 (mm)
ID 1 : 196 (mm)
ID 2 : 17 (mm)

CONT : 1
VOL : 0.046

SFA 0810P Air Filter Primary Soft PU end cap Element

DEMAG 115 169 74
COMP AIR 11516/974
ATLAS COPCO 2914-5017-00
DEMAG 41136512
TEREX 41136512

















Secondary Filter uses SFA 8100S
Set Filter uses SFA 0810SET

H 1 : 594 (mm)
H 2 : 557 (mm)
OD 1 : 299 (mm)
OD 2 : 299 (mm)
ID 1 : 202 (mm)

CONT : 1
VOL : 0.061



Product Guide

<p>SFA 0851P</p> <p>Air Filter Primary Metal End Cap Element</p> <p>HITACHI 408065 CASE 45252 STEIGER 45252 INGERSOLL RAND 506163930</p>  <p>Secondary Filter uses SFA 0883S Set Filter uses SFA 0851SET H 1 : 470 (mm) H 2 : 457 (mm) OD 1 : 352 (mm) OD 2 : 352 (mm) ID 1 : 241 (mm) ID 2 : 23 (mm)</p> <p>CONT : 1 VOL : 0.071</p>	<p>SFA 1042P</p> <p>Air Filter Primary Metal End Cap Element</p> <p>CUMMINS 3013212 CATERPILLAR 3I-0795 HITACHI 4206272</p>  <p>Secondary Filter uses SFA 8408S Set Filter uses SFA 1042SET H 1 : 623 (mm) H 2 : 610 (mm) OD 1 : 373 (mm) OD 2 : 373 (mm) ID 1 : 263 (mm) ID 2 : 23 (mm)</p> <p>CONT : 1 VOL : 0.103</p>	<p>SFA 1087P</p> <p>Air Filter Primary Metal End Cap Element</p> <p>ATLAS COPCO 1619-27-98-00 DEUTZ 2165041 DEUTZ 2165054</p>  <p>Secondary Filter uses SFA 1200S Set Filter uses SFA 4401SET H 1 : 384 (mm) H 2 : 371 (mm) OD 1 : 228 (mm) OD 2 : 228 (mm) ID 1 : 117 (mm) ID 2 : 11 (mm)</p> <p>CONT : 1 VOL : 0.026</p> <p>Note :</p>
<p>SFA 0851SET</p> <p>Air Filter Set Metal End Cap Element</p> <p>VOLVO 4881174 + 4881175 EUCLID 9035992+9035993</p>  <p>Primary Filter uses SFA 0851P Secondary Filter uses SFA 0883S H 1 : 470 (mm) H 2 : 457 (mm) OD 1 : 352 (mm) OD 2 : 352 (mm) ID 1 : 241 (mm) ID 2 : 23 (mm)</p> <p>CONT : 1 VOL : 0.071</p>	<p>SFA 1052PF</p> <p>Air Filter Primary Metal End Cap Element With Sleeve</p> <p>ISUZU 1-14215135-0 KUBOTA 15606-11080 YANMAR 171064-12540</p>  <p>Secondary Filter uses SFA 3160S Set Filter uses SFA 1052SET H 1 : 288 (mm) H 2 : 279 (mm) OD 1 : 160 (mm) OD 2 : 134 (mm) ID 1 : 66.5 (mm) ID 2 : 17 (mm)</p> <p>CONT : 9 VOL : 0.096</p>	<p>SFA 1088P</p> <p>Air Filter Primary Metal End Cap Element</p> <p>MERCEDES-BENZ 001 094 46 04 DEUTZ 2165044</p>  <p>Secondary Filter uses SFA 0800S Set Filter uses SFA 1088SET H 1 : 353 (mm) H 2 : 340 (mm) OD 1 : 164 (mm) OD 2 : 164 (mm) ID 1 : 87 (mm) ID 2 : 8.5 (mm)</p> <p>CONT : 9 VOL : 0.107</p>
<p>SFA 0883S</p> <p>Air Filter Secondary Metal End Cap Element</p> <p>CATERPILLAR 1N-8164 CATERPILLAR 4N-9164 INGERSOLL RAND 50616408</p>  <p>Primary Filter uses SFA 0851P Set Filter uses SFA 0851SET H 1 : 433 (mm) H 2 : 423 (mm) OD 1 : 220 (mm) OD 2 : 220 (mm) ID 1 : 179 (mm) ID 2 : 23 (mm)</p> <p>CONT : 4 VOL : 0.106</p>	<p>SFA 1054P</p> <p>Air Filter Primary Metal End Cap Element</p> <p>CHRYSLER 3614353 KOMATSU 600-181-8240</p>  <p>Secondary Filter uses SFA 1394S Set Filter uses SFA 1054PSET H 1 : 311 (mm) H 2 : 305 (mm) OD 1 : 155 (mm) OD 2 : 155 (mm) ID 1 : 88 (mm) ID 2 : 17 (mm)</p> <p>CONT : 4 VOL : 0.047</p>	<p>SFA 1089P</p> <p>Air Filter Primary Metal End Cap Element</p> <p>DEUTZ 2165038</p>  <p>Secondary Filter uses SFA F700S Set Filter uses SFA 1089SET H 1 : 338 (mm) H 2 : 325 (mm) OD 1 : 148 (mm) OD 2 : 148 (mm) ID 1 : 72 (mm) ID 2 : 8.5 (mm)</p> <p>CONT : 9 VOL : 0.093</p>
<p>SFA 1000S</p> <p>Air Filter Secondary Metal End Cap Element</p> <p>MERCEDES-BENZ 002 094 32 04 DEUTZ 2241329 HITACHI 5025800</p>  <p>Primary Filter uses SFA 0123P Set Filter uses SFA 0123SET H 1 : 373 (mm) OD 1 : 110 (mm) OD 2 : 99.5 (mm) ID 1 : 90.4 (mm) ID 2 : 17 (mm)</p> <p>CONT : 16 VOL : 0.090</p>	<p>SFA 1054PF</p> <p>Air Filter Primary Metal End Cap Element With Sleeve</p> <p>MAZDA 0727-23-603 ISUZU 1-14215028-0 ISUZU 1-14215032-0</p>  <p>Secondary Filter uses SFA 1394S Set Filter uses SFA 1054SET H 1 : 311 (mm) H 2 : 305 (mm) OD 1 : 199 (mm) OD 2 : 155 (mm) ID 1 : 88 (mm) ID 2 : 17 (mm)</p> <p>CONT : 12 VOL : 0.211</p>	<p>SFA 1090P</p> <p>Air Filter Primary Metal End Cap Element</p> <p>MASSEY-FERGUSON 3074305 M1 CATERPILLAR 3I-0838</p>  <p>Secondary Filter uses SFA 0804S Set Filter uses SFA 1090SET H 1 : 420 (mm) H 2 : 406.5 (mm) OD 1 : 234 (mm) OD 2 : 234 (mm) ID 1 : 123 (mm) ID 2 : 17 (mm)</p> <p>CONT : 4 VOL : 0.119</p>
<p>SFA 1002P</p> <p>Air Filter Primary Metal End Cap Element</p> <p>NISSAN 16546-97004 HINO 17801-2550 HITACHI 4177213</p>  <p>Secondary Filter uses SFA 9372S Set Filter uses SFA 7033SET H 1 : 470 (mm) H 2 : 457 (mm) OD 1 : 307 (mm) OD 2 : 307 (mm) ID 1 : 196 (mm) ID 2 : 17 (mm)</p> <p>CONT : 1 VOL : 0.055</p>	<p>SFA 1054PSET</p> <p>Air Filter Set Metal End Cap Element</p> <p>CLAAS 3200010+3200020 BLOUNT 537986+537987 BOBCAT 6681474+6681475 JOHN DEERE AT44377+AT44378</p>  <p>Primary Filter uses SFA 1054P Secondary Filter uses SFA 1394S H 1 : 311 (mm) H 2 : 305 (mm) OD 1 : 155 (mm) OD 2 : 155 (mm) ID 1 : 88 (mm) ID 2 : 17 (mm)</p> <p>CONT : 4 VOL : 0.043</p>	<p>SFA 1091P</p> <p>Air Filter Primary Metal End Cap Element</p> <p>JOHN DEERE AR-70106</p>  <p>Secondary Filter uses SFA 0772S Set Filter uses SFA 1091SET H 1 : 521 (mm) H 2 : 508 (mm) OD 1 : 264 (mm) OD 2 : 264 (mm) ID 1 : 153 (mm) ID 2 : 23 (mm)</p> <p>CONT : 1 VOL : 0.045</p>



To order, please call:
+1 8448 BE SURE; +1 (925) 566-8863















FOR REFERENCE ONLY - REPRESENTATIVE PICTURE ONLY



Email :
order@surefilter.us



Product Guide

<p>SFA 1200S</p>  <p>CONT : 16 VOL : 0.133</p>	<p>Air Filter Secondary Metal End Cap Element</p> <p>MERCEDES-BENZ 003 094 45 04 DEUTZ 42480759 INGERSOLL RAND 92686930</p> <p>Primary Filter uses SFA 1087P Set Filter uses SFA 4401SET H 1 : 380 (mm) OD 1 : 121 (mm) OD 2 : 111 (mm) ID 1 : 105 (mm) ID 2 : 17 (mm)</p>	<p>SFA 1500S</p>  <p>CONT : 16 VOL : 0.117</p>	<p>Air Filter Secondary Soft PU end cap Element</p> <p>VOLVO 2908238 MASSEY-FERGUSON 3901478M1 J.C.BAMFORD 580-12021</p> <p>Primary Filter uses SFA 0500P Set Filter uses SFA 0500SET H 1 : 386 (mm) H 2 : 380 (mm) OD 1 : 104 (mm) OD 2 : 107 (mm) ID 1 : 93 (mm)</p>	<p>SFA 1802P</p>  <p>CONT : 1 VOL : 0.054</p>	<p>Air Filter Primary Metal End Cap Element</p> <p>MERCEDES-BENZ 003 094 50 04 MAN 81.08304.0038 MAN 81.08304.0044 INGERSOLL RAND 92035948</p> <p>Secondary Filter uses SFA 1600S Set Filter uses SFA 1802SET H 1 : 473 (mm) H 2 : 460 (mm) OD 1 : 302 (mm) OD 2 : 302 (mm) ID 1 : 191 (mm) ID 2 : 11 (mm)</p>
<p>SFA 1300S</p>  <p>CONT : 9 VOL : 0.116</p>	<p>Air Filter Secondary Metal End Cap Element</p> <p>DEUTZ 414 4966 VOLVO 4785749 MAN 51.08405-0001 FORD 86509129</p> <p>Primary Filter uses SFA 6501P Set Filter uses SFA 6501SET H 1 : 480 (mm) OD 1 : 141 (mm) OD 2 : 127 (mm) ID 1 : 116 (mm) ID 2 : 17 (mm)</p>	<p>SFA 1600S</p>  <p>CONT : 9 VOL : 0.150</p>	<p>Air Filter Secondary Metal End Cap Element</p> <p>MAN 81.08405.0011 MAN 81.0845.0013 INGERSOLL RAND 92035955</p> <p>Primary Filter uses SFA 1802P H 1 : 471 (mm) H 2 : 471 (mm) OD 1 : 161.2 (mm) OD 2 : 151 (mm) ID 1 : 141.2 (mm) ID 2 : 17 (mm)</p>	<p>SFA 1950SET</p>  <p>CONT : 4 VOL : 0.081</p>	<p>Air Filter Set Metal End Cap Element With Sleeve</p> <p>KOMATSU 600-181-9500</p> <p>Primary Filter uses SFA 1733PF Secondary Filter uses SFA 1680S H 1 : 381 (mm) H 2 : 330 (mm) OD 1 : 199 (mm) OD 2 : 155 (mm) ID 1 : 88 (mm) ID 2 : 17 (mm)</p>
<p>SFA 1398P</p>  <p>CONT : 1 VOL : 0.070</p>	<p>Air Filter Primary Soft PU end cap Element</p> <p>VOLVO 11110217</p> <p>Secondary Filter uses SFA 1399S H 1 : 493 (mm) H 2 : 480 (mm) OD 1 : 362 (mm) OD 2 : 362 (mm) ID 1 : 229 (mm)</p>	<p>SFA 1733PF</p>  <p>CONT : 4 VOL : 0.081</p>	<p>Air Filter Primary Metal End Cap Element With Sleeve</p> <p>MASSEY-FERGUSON 1093682M91 ISUZU 14215-166 IVECO 8014390</p> <p>Secondary Filter uses SFA 4103S Set Filter uses SFA 1733SET H 1 : 392 (mm) H 2 : 381 (mm) OD 1 : 199 (mm) OD 2 : 155 (mm) ID 1 : 88 (mm) ID 2 : 17 (mm)</p>	<p>SFA 2073S</p>  <p>CONT : 4 VOL : 0.121</p>	<p>Air Filter Secondary Metal End Cap Element</p> <p>FIAT 107030 FIAT 1930901</p> <p>Primary Filter uses SFA 2536P H 1 : 486 (mm) OD 1 : 215 (mm) OD 2 : 185 (mm) ID 1 : 157.5 (mm) ID 2 : 17 (mm)</p>
<p>SFA 1398SET</p>  <p>CONT : 1 VOL : 0.081</p>	<p>Air Filter Set Soft PU end cap Element</p> <p>VOLVO 11110217+1110218</p> <p>Primary Filter uses SFA 1398P Secondary Filter uses SFA 1399S H 1 : 493 (mm) H 2 : 480 (mm) OD 1 : 362 (mm) OD 2 : 362 (mm) ID 1 : 229 (mm)</p>	<p>SFA 1733SET</p>  <p>CONT : 4 VOL : 0.081</p>	<p>Air Filter Set Metal End Cap Element With Sleeve</p> <p>MASSEY-FERGUSON 1093682M91+1093683M91</p> <p>Primary Filter uses SFA 1733PF Secondary Filter uses SFA 4103S H 1 : 392 (mm) H 2 : 381 (mm) OD 1 : 199 (mm) OD 2 : 155 (mm) ID 1 : 88 (mm) ID 2 : 17 (mm)</p>	<p>SFA 2100S</p>  <p>CONT : 4 VOL : 0.135</p>	<p>Air Filter Secondary Metal End Cap Element</p> <p>DEUTZ 1602 6337 LIEBHERR 571 890 708 BOMAG 5821182 LIEBHERR 736 8215 NEW HOLLAND (CNH) 8983 5746</p> <p>Primary Filter uses SFA 9203P Set Filter uses SFA 9203SET H 1 : 609 (mm) OD 1 : 211 (mm) OD 2 : 202 (mm) ID 1 : 190 (mm) ID 2 : 18 (mm)</p>
<p>SFA 1399S</p>  <p>CONT : 1 VOL : 0.029</p>	<p>Air Filter Secondary Soft PU end cap Element</p> <p>VOLVO 11110218</p> <p>Primary Filter uses SFA 1398P H 1 : 484 (mm) OD 1 : 229 (mm) OD 2 : 220 (mm) ID 1 : 175 (mm)</p>	<p>SFA 1735PF</p>  <p>CONT : 4 VOL : 0.115</p>	<p>Air Filter Primary Metal End Cap Element With Sleeve</p> <p>NISSAN 16546-95009 KOBELCO 2446R277S5 FIAT 266787</p> <p>Secondary Filter uses SFA 4150S Set Filter uses SFA 1735SET H 1 : 419 (mm) H 2 : 406 (mm) OD 1 : 225 (mm) OD 2 : 174 (mm) ID 1 : 107.5 (mm) ID 2 : 17 (mm)</p>	<p>SFA 2361P</p>  <p>CONT : 1 VOL : 0.026</p>	<p>Air Filter Primary Soft PU end cap Element</p> <p>ATLAS COPCO 2914 9310 J.C.BAMFORD 32/920401</p> <p>Secondary Filter uses SFA 2782S Set Filter uses SFA 2361SET H 1 : 405 (mm) H 2 : 368 (mm) OD 1 : 220 (mm) OD 2 : 220 (mm) ID 1 : 125 (mm)</p>



To order, please call:
+1 8448 BE SURE; +1 (925) 566-8863















FOR REFERENCE ONLY - REPRESENTATIVE PICTURE ONLY



Email :
order@surefilter.us



Product Guide

<p>SFA 2523P</p> <p>Air Filter Primary Metal End Cap Element</p> <p>LOESING 020083 FIAT 1849136 CASE-IH CNH 1930788 CATERPILLAR 311419</p>  <p>Secondary Filter uses SFA 9373S Set Filter uses SFA 2523P H 1 : 425 (mm) H 2 : 412 (mm) OD 1 : 307 (mm) OD 2 : 307 (mm) ID 1 : 196 (mm) ID 2 : 17 (mm)</p> <p>CONT : 1 VOL : 0.047</p> <p>Note : Is a long life version of SFA 1523P</p>	<p>SFA 3108SET</p> <p>Air Filter Set Soft PU end cap Element</p> <p>LIEBHERR 10217169+10217168 MAN 64.08301-0008+64.08301-0009</p>  <p>Primary Filter uses SFA 3108P Secondary Filter uses SFA 3109S H 1 : 519 (mm) H 2 : 517 (mm) OD 1 : 263 (mm) OD 2 : 263 (mm) ID 1 : 129 (mm)</p> <p>CONT : 1 VOL : 0.042</p>	<p>SFA 4905P</p> <p>Air Filter Primary Metal End Cap Element</p> <p>ATLAS COPCO 3216-7082-01</p>  <p>Secondary Filter uses SFA 4589S Set Filter uses SFA 4905SET H 1 : 420 (mm) H 2 : 407 (mm) OD 1 : 234 (mm) OD 2 : 276 (mm) ID 1 : 122.5 (mm) ID 2 : 15 (mm)</p> <p>CONT : 1 VOL : 0.041</p>
<p>SFA 2523SET</p> <p>Air Filter Set Metal End Cap Element</p> <p>FIAT-AGRI 1930788+1930748 RENAULT 500953712+3564119 LIEBHERR 7615043+7362687 JOHN DEERE AZ39761+U44956</p>  <p>Primary Filter uses SFA 2523P Secondary Filter uses SFA 9373S H 1 : 425 (mm) H 2 : 412 (mm) OD 1 : 307 (mm) OD 2 : 307 (mm) ID 1 : 196 (mm) ID 2 : 17 (mm)</p> <p>CONT : 1 VOL : 0.047</p>	<p>SFA 3109S</p> <p>Air Filter Secondary Soft PU end cap Element</p> <p>LIEBHERR 10217168 MAN 64.08301-0009</p>  <p>Primary Filter uses SFA 3108P Set Filter uses SFA 3108SET H 1 : 495 (mm) H 2 : 493.5 (mm) OD 1 : 205 (mm) OD 2 : 106 (mm) ID 1 : 129 (mm)</p> <p>CONT : 4 VOL : 0.107</p>	<p>SFA 5479P</p> <p>Air Filter Primary Soft PU end cap Element</p> <p>MANITOU 775479</p>  <p>Secondary Filter uses SFA 5480S Set Filter uses SFA 5479SET H 1 : 394.5 (mm) H 2 : 385 (mm) OD 1 : 186 (mm) OD 2 : 184 (mm) ID 1 : 105.5 (mm)</p> <p>CONT : 1 VOL : 0.000</p>
<p>SFA 2536P</p> <p>Air Filter Primary Metal End Cap Element</p> <p>FIAT 107029</p>  <p>Secondary Filter uses SFA 2073S H 1 : 521 (mm) H 2 : 508 (mm) OD 1 : 307 (mm) OD 2 : 307 (mm) ID 1 : 196 (mm) ID 2 : 17 (mm)</p> <p>CONT : 1 VOL : 0.055</p>	<p>SFA 4103S</p> <p>Air Filter Secondary Metal End Cap Element</p> <p>MASSEY-FERGUSON 1093683M91 FIAT-ALLIS 1909964 IVECO 8015449</p>  <p>Primary Filter uses SFA 2801PF Set Filter uses SFA 2801SET H 1 : 357 (mm) H 2 : 355.5 (mm) OD 1 : 105 (mm) OD 2 : 85.5 (mm) ID 1 : 73.5 (mm) ID 2 : 17 (mm)</p> <p>CONT : 9 VOL : 0.059</p> <p>Note : Is a Secondary Air filter for SFA 2801PF,SFA 1733PF,SFA 0262PF</p>	<p>SFA 5479SET</p> <p>Air Filter Set Soft PU end cap Element</p> <p>MANITOU 77549+775480</p>  <p>Primary Filter uses SFA 5479P Secondary Filter uses SFA 5480S H 1 : 395 (mm) H 2 : 385 (mm) OD 1 : 186 (mm) OD 2 : 184 (mm) ID 1 : 87 (mm)</p> <p>CONT : 0 VOL : 0.000</p>
<p>SFA 2536SET</p> <p>Air Filter Set Metal End Cap Element</p> <p>IVECO 107029 + 107030</p>  <p>Primary Filter uses SFA 2536P Secondary Filter uses SFA 2073S H 1 : 521 (mm) H 2 : 508 (mm) OD 1 : 307 (mm) OD 2 : 307 (mm) ID 1 : 196 (mm) ID 2 : 17 (mm)</p> <p>CONT : 1 VOL : 0.058</p>	<p>SFA 4150S</p> <p>Air Filter Secondary Metal End Cap Element</p> <p>NISSAN 16546-95010 CATERPILLAR 5W-2716 INTERNATIONAL HARVESTER 681545 R1</p>  <p>Primary Filter uses SFA 1735PF Set Filter uses SFA 1735SET H 1 : 383 (mm) H 2 : 381 (mm) OD 1 : 123 (mm) OD 2 : 106 (mm) ID 1 : 93 (mm) ID 2 : 17 (mm)</p> <p>CONT : 9 VOL : 0.072</p>	<p>SFA 5480S</p> <p>Air Filter Secondary Soft PU end cap Element</p> <p>MANITOU 775480</p>  <p>H 1 : 382.5 (mm) H 2 : 378 (mm) OD 1 : 106 (mm) OD 2 : 100 (mm) ID 1 : 87 (mm)</p> <p>CONT : 0 VOL : 0.000</p>
<p>SFA 3108P</p> <p>Air Filter Primary Soft PU end cap Element</p> <p>LIEBHERR 10217169 MAN 64.08301-0008</p>  <p>Secondary Filter uses SFA 3109S Set Filter uses SFA 3108SET H 1 : 519 (mm) H 2 : 517 (mm) OD 1 : 263 (mm) OD 2 : 263 (mm) ID 1 : 164.5 (mm)</p> <p>CONT : 4 VOL : 0.182</p>	<p>SFA 4589S</p> <p>Air Filter Secondary Metal End Cap Element</p> <p>NISSAN 16546-Z5003 ATLAS COPCO 3216-708202 CATERPILLAR 31-0069 JOHN DEERE T46317</p>  <p>Primary Filter uses SFA 4905P Set Filter uses SFA 4905SET H 1 : 387 (mm) H 2 : 381 (mm) OD 1 : 116 (mm) OD 2 : 116 (mm) ID 1 : 88 (mm) ID 2 : 17 (mm)</p> <p>CONT : 16 VOL : 0.117</p>	<p>SFA 5485S</p> <p>Air Filter Secondary Soft PU end cap Element</p> <p>YANMAR 119117-12570 CATERPILLAR 1318903 PERKINS 26510343 YANMAR Y119117-12570</p>  <p>Primary Filter uses SFA 8889P Set Filter uses SFA 8889SET H 1 : 346 (mm) H 2 : 340 (mm) OD 1 : 92 (mm) OD 2 : 86.5 (mm) ID 1 : 72.5 (mm)</p> <p>CONT : 25 VOL : 0.110</p> <p>Note : Set filter uses SFA 8889 Set(Soft PU+Metal)</p>



To order, please call:
+1 8448 BE SURE; +1 (925) 566-8863















FOR REFERENCE ONLY - REPRESENTATIVE PICTURE ONLY



Email :
order@surefilter.us



Product Guide

<p>SFA 5491S</p>  <p>CONT : 25 VOL : 0.173</p>	<p>Air Filter Secondary Soft PU end cap Element</p> <p>PERKINS 26510354 J.C.BAMFORD 32/912902 KOMATSU 42X01H0P01 KOMATSU 600-185-3120</p> <p>Primary Filter uses SFA 5492P Set Filter uses SFA 5492SET H 1 : 407.5 (mm) H 2 : 401 (mm) OD 1 : 108 (mm) OD 2 : 100 (mm) ID 1 : 87 (mm)</p>	<p>SFA 7250P</p>  <p>CONT : 9 VOL : 0.102</p>	<p>Air Filter Primary Metal End Cap Element</p> <p>DEUTZ 2339823</p> <p>Secondary Filter uses SFA 0811S Set Filter uses SFA 7250SET H 1 : 329 (mm) H 2 : 320 (mm) OD 1 : 164 (mm) OD 2 : 164 (mm) ID 1 : 86 (mm)</p>	<p>SFA 7638PF</p>  <p>CONT : 1 VOL : 0.021</p> <p>Note : For Flame Retardant version,use SFA 76381PF</p>	<p>Air Filter Primary Soft PU end cap Element With Sleeve</p> <p>CATERPILLAR 1527217 J.C.BAMFORD 32/912901 NEW HOLLAND (CNH) 82034620 FENDT H515200090100</p> <p>Secondary Filter uses SFA 5491S Set Filter uses SFA 7638SET H 1 : 423 (mm) H 2 : 410 (mm) OD 1 : 207 (mm) OD 2 : 207 (mm) ID 1 : 106.5 (mm)</p>
<p>SFA 6501P</p>  <p>CONT : 1 VOL : 0.034</p>	<p>Air Filter Primary Metal End Cap Element</p> <p>MERCEDES-BENZ 001 094 79 04 MERCEDES-BENZ 012 094 87 02 IVECO 2165059</p> <p>Secondary Filter uses SFA 1300S Set Filter uses SFA 6501SET H 1 : 495 (mm) H 2 : 482 (mm) OD 1 : 241.5 (mm) OD 2 : 241.5 (mm) ID 1 : 137 (mm) ID 2 : 11 (mm)</p>	<p>SFA 7250SET</p>  <p>CONT : 9 VOL : 0.116</p>	<p>Air Filter Set Metal End Cap Element</p> <p>KHD(KLOCKNER-HUMBOLT-DEUTZ) 2339823+2379163</p> <p>Primary Filter uses SFA 7250P Secondary Filter uses SFA 0811S H 1 : 329 (mm) H 2 : 320 (mm) OD 1 : 164 (mm) OD 2 : 164 (mm) ID 1 : 86 (mm)</p>	<p>SFA 77251P</p>  <p>CONT : 9 VOL : 0.116</p> <p>Note : Flame Retardant version of SFA 8889P</p>	<p>Air Filter Primary Soft PU end cap Element flame retardant media</p> <p>CLARK 1241080 TOYOTA 17741-U3330-71 KOMATSU 3EC02A541E LIUGONG 40C0496</p> <p>H 1 : 356 (mm) H 2 : 347 (mm) OD 1 : 163.5 (mm) OD 2 : 163.5 (mm) ID 1 : 91 (mm)</p>
<p>SFA 7134P</p>  <p>CONT : 18 VOL : 0.133</p>	<p>Air Filter Primary Metal End Cap Element normal media</p> <p>DEUTZ 231 1565 DEUTZ 233 9813</p> <p>Secondary Filter uses SFA 0711S Set Filter uses SFA 7134SET H 1 : 211 (mm) H 2 : 202 (mm) OD 1 : 164 (mm) OD 2 : 164 (mm) ID 1 : 86 (mm)</p>	<p>SFA 7406P</p>  <p>CONT : 1 VOL : 0.028</p>	<p>Air Filter Primary Soft PU end cap Element</p> <p>LIEBHERR 10021425</p> <p>Secondary Filter uses SFA 7154S Set Filter uses SFA 7406SET H 1 : 423 (mm) H 2 : 410 (mm) OD 1 : 237 (mm) OD 2 : 237 (mm) ID 1 : 132 (mm)</p>	<p>SFA 7781S</p>  <p>CONT : 1 VOL : 0.062</p>	<p>Air Filter Secondary Metal End Cap Element</p> <p>CATERPILLAR 3I-0105 KOMATSU 581-02-12130 EUCLID 9038349</p> <p>Primary Filter uses SFA 1040P Set Filter uses SFA 1040SET H 1 : 572 (mm) H 2 : 559 (mm) OD 1 : 301.5 (mm) OD 2 : 301.5 (mm) ID 1 : 260.5 (mm) ID 2 : 23 (mm)</p>
<p>SFA 7134SET</p>  <p>CONT : 18 VOL : 0.131</p>	<p>Air Filter Set Metal End Cap Element</p> <p>KHD(KLOCKNER-HUMBOLT-DEUTZ) 2311565+4308634 KHD(KLOCKNER-HUMBOLT-DEUTZ) 2339813+2379161</p> <p>Primary Filter uses SFA 7134P Secondary Filter uses SFA 0711S H 1 : 211 (mm) H 2 : 202 (mm) OD 1 : 164 (mm) OD 2 : 164 (mm) ID 1 : 86 (mm)</p>	<p>SFA 7406SET</p>  <p>CONT : 1 VOL : 0.028</p>	<p>Air Filter Set Soft PU end cap Element</p> <p>LIEBHERR 10021425+10021426</p> <p>Primary Filter uses SFA 7406P Secondary Filter uses SFA 7154S H 1 : 423 (mm) H 2 : 410 (mm) OD 1 : 237 (mm) OD 2 : 237 (mm) ID 1 : 95.5 (mm)</p>	<p>SFA 7805S</p>  <p>CONT : 25 VOL : 0.102</p>	<p>Air Filter Secondary Soft PU end cap Element</p> <p>KHD(KLOCKNER-HUMBOLT-DEUTZ) 0441 5906 VOLVO (TRUCK/VCE/VME/PENTA) 11705111 MASSEY-FERGUSON 3901476M1</p> <p>Primary Filter uses SFA 7804P Set Filter uses SFA 7804SET H 1 : 360 (mm) OD 1 : 85.6 (mm) OD 2 : 85 (mm) ID 1 : 71 (mm)</p>
<p>SFA 7154S</p>  <p>CONT : 9 VOL : 0.097</p>	<p>Air Filter Secondary Soft PU end cap Element</p> <p>LIEBHERR 10021426</p> <p>Primary Filter uses SFA 7406P Set Filter uses SFA 7406SET H 1 : 406 (mm) H 2 : 400 (mm) OD 1 : 134 (mm) OD 2 : 125 (mm) ID 1 : 95.5 (mm)</p>	<p>SFA 7435P</p>  <p>CONT : 1 VOL : 0.050</p>	<p>Air Filter Primary Metal End Cap Element</p> <p>HINO 17801-2020 HINO 17801-2270 HINO 17801-2290</p> <p>Secondary Filter uses SFA 9370S Set Filter uses SFA 7435SET H 1 : 419 (mm) H 2 : 406 (mm) OD 1 : 307 (mm) OD 2 : 307 (mm) ID 1 : 196 (mm) ID 2 : 23 (mm)</p>	<p>SFA 78681PF</p>  <p>CONT : 1 VOL : 0.059</p>	<p>Air Filter Primary Soft PU+Metal Element With Sleeve</p> <p>HITACHI 76612497</p> <p>Secondary Filter uses SFA 7869S Set Filter uses SFA 78681SET H 1 : 521 (mm) H 2 : 510 (mm) OD 1 : 313 (mm) OD 2 : 313 (mm) ID 1 : 178 (mm)</p>



To order, please call:
+1 8448 BE SURE; +1 (925) 566-8863

FOR REFERENCE ONLY - REPRESENTATIVE PICTURE ONLY



Email :
order@surefilter.us



Product Guide

SFA 7868PF Air Filter Primary Soft PU end cap Element With Sleeve

VOLVO 11033996
CATERPILLAR 142-1340
ATLAS COPCO 3222-1881-91
FIAT 4466269

Secondary Filter uses SFA 7869S

H 1 : 521 (mm)
H 2 : 510 (mm)
OD 1 : 313 (mm)
OD 2 : 313 (mm)
ID 1 : 178 (mm)

CONT : 1
VOL : 0.057



SFA 7875S Air Filter Secondary Soft PU end cap Element

VOLVO CONSTRUCTION EQUIPMENT 11033999
VOLVO CONSTRUCTION EQUIPMENT 11033999-1

Primary Filter uses SFA 7871P

H 1 : 563 (mm)
H 2 : 557 (mm)
OD 1 : 179 (mm)
OD 2 : 174 (mm)
ID 1 : 148 (mm)

CONT : 6
VOL : 0.136



SFA 9203P Air Filter Primary Metal End Cap Element

KHD(KLOCKNER-HUMBOLT-DEUTZ) 12189925
SHICK 51601-003-00

Secondary Filter uses SFA 2100S
Set Filter uses SFA 9203SET

H 1 : 621 (mm)
H 2 : 608 (mm)
OD 1 : 324 (mm)
OD 2 : 324 (mm)
ID 1 : 212 (mm)
ID 2 : 13.5 (mm)

CONT : 1
VOL : 0.075



SFA 7868SETF Air Filter Set Soft PU end cap Element With Sleeve

HITACHI 76612497+4466268
SANY B22210000641+B22210000640

H 1 : 521 (mm)
H 2 : 510 (mm)
OD 1 : 313 (mm)
OD 2 : 313 (mm)
ID 1 : 178 (mm)

CONT : 1
VOL : 0.059



SFA 8408S Air Filter Secondary Metal End Cap Element

CATERPILLAR 1N-4864
CUMMINS 3013213
CATERPILLAR 3I-0215

Primary Filter uses SFA 1042P
Set Filter uses SFA 1042SET

H 1 : 572 (mm)
H 2 : 559 (mm)
OD 1 : 260 (mm)
OD 2 : 260 (mm)
ID 1 : 231.5 (mm)
ID 2 : 23 (mm)

CONT : 1
VOL : 0.049



SFA 9203SET Air Filter Set Element

MAN 81.08401.6082+81.08304.0066
NEW HOLLAND (CNH) 89835747+9835746

Primary Filter uses SFA 9203P
Secondary Filter uses SFA 2100S

H 1 : 620.4 (mm)
H 2 : 608 (mm)
OD 1 : 324 (mm)
OD 2 : 324 (mm)
ID 1 : 212 (mm)
ID 2 : 13.5 (mm)

CONT : 1
VOL : 0.072



SFA 7869S Air Filter Secondary Soft PU end cap Element

CATERPILLAR 142-1403
ATLAS COPCO 3222-1881-92
HITACHI 4466268

Primary Filter uses SFA 7868P
Set Filter uses SFA 7868SET

H 1 : 500 (mm)
H 2 : 494 (mm)
OD 1 : 179 (mm)
OD 2 : 174 (mm)
ID 1 : 143 (mm)

CONT : 1
VOL : 0.021

Note : Is a Secondary Air filter of SFA 7868P,SFA 7548P



SFA 88891P Air Filter Primary Soft PU+Metal Element

CATERPILLAR 131-8902
LIUGONG 40C0496

Secondary Filter uses SFA 5485S
Set Filter uses SFA 88891SET

H 1 : 356 (mm)
H 2 : 347 (mm)
OD 1 : 163.5 (mm)
OD 2 : 163.5 (mm)
ID 1 : 91 (mm)

CONT : 9
VOL : 0.108

Note : with reinforcement metal



SFA 9370S Air Filter Secondary Metal End Cap Element

NISSAN 16546-90204
INTERNATIONAL HARVESTER 702753 C1

Primary Filter uses SFA 7435P
Set Filter uses SFA 7435SET

H 1 : 394 (mm)
H 2 : 381 (mm)
OD 1 : 194 (mm)
OD 2 : 194 (mm)
ID 1 : 153 (mm)
ID 2 : 23 (mm)

CONT : 4
VOL : 0.081



SFA 7871P Air Filter Primary Soft PU end cap Element

VOLVO CONSTRUCTION EQUIPMENT 11033998
VOLVO CONSTRUCTION EQUIPMENT 11033998-3

Secondary Filter uses SFA 7875S

H 1 : 580 (mm)
H 2 : 569 (mm)
OD 1 : 313 (mm)
OD 2 : 313 (mm)
ID 1 : 178 (mm)

CONT : 1
VOL : 0.065



SFA 88891SET Air Filter Set Soft PU+Metal Element

CATERPILLAR 131-8902+131-8903
LIUGONG 40C0496

Primary Filter uses SFA 88891P
Secondary Filter uses SFA 5485S

H 1 : 356 (mm)
H 2 : 347 (mm)
OD 1 : 163.5 (mm)
OD 2 : 163.5 (mm)
ID 1 : 91 (mm)

CONT : 9
VOL : 0.116

Note : with reinforcement metal



SFA 9372S Air Filter Secondary Metal End Cap Element

NISSAN 16546-97005
CATERPILLAR 3I-0125
HITACHI 4177212

Primary Filter uses SFA 5702P
Set Filter uses SFA 6244SET

H 1 : 449 (mm)
OD 1 : 215 (mm)
OD 2 : 185 (mm)
ID 1 : 157.5 (mm)
ID 2 : 17 (mm)

CONT : 4
VOL : 0.106

Note : Is a Secondary Air filter for SFA 5702P,SFA 1002P



SFA 7871SET Air Filter Set Soft PU end cap Element

VOLVO 11033998+11033999
VOLVO 110339983+11033991
TEREX 15272252+15272253
CASE 84069017+84069018

Primary Filter uses SFA 7871P
Secondary Filter uses SFA 7875S

H 1 : 580 (mm)
H 2 : 569 (mm)
OD 1 : 313 (mm)
OD 2 : 313 (mm)
ID 1 : 178 (mm)

CONT : 1
VOL : 0.065



SFA 8889P Air Filter Primary Soft PU end cap Element

YANMAR 119117-12560
CATERPILLAR 131-8902
PERKINS 26510342
LIUGONG 40C0496
HITACHI 4486002

Secondary Filter uses SFA 5485S
Set Filter uses SFA 8889SET

H 1 : 356 (mm)
H 2 : 347 (mm)
OD 1 : 163.5 (mm)
OD 2 : 163.5 (mm)
ID 1 : 91 (mm)

CONT : 9
VOL : 0.120



SFA 9373S Air Filter Secondary Metal End Cap Element

ISUZU 1-14215034-0
ISUZU 1-14215036-0
NISSAN 16546-96014

Primary Filter uses SFA 1046P
Set Filter uses SFA 3800SET

H 1 : 406 (mm)
OD 1 : 192 (mm)
OD 2 : 162.5 (mm)
ID 1 : 134 (mm)
ID 2 : 17 (mm)

CONT : 4
VOL : 0.077

Note : Is a Secondary Air filter for SFA 1046P,SFA 2523P





Product Guide

SFA 9773S Air Filter Secondary Soft PU end cap Element
LIEBHERR 10279773



Primary Filter uses SFA 9775PF
Set Filter uses SFA 9775SET
H 1 : 446 (mm)
H 2 : 440 (mm)
OD 1 : 179 (mm)
OD 2 : 174 (mm)
ID 1 : 148 (mm)

CONT : 6
VOL : 0.117

SFF 0404 Fuel Filter Secondary Metal End Cap Element
MERCEDES-BENZ 000 477 40 15
MERCEDES-BENZ 000 477 45 15



H 1 : 145 (mm)
H 2 : 138 (mm)
OD 1 : 83 (mm)
OD 2 : 83 (mm)
ID 1 : 14 (mm)
ID 2 : 14 (mm)

CONT : 50
VOL : 0.113

SFF 105DN Fuel Filter Spin-On With Nut
CASE 244458R92
FORD 749F9176AAA
FIAT-ALLIS 76190709
CLARK 949095
CLARK M0949095



H 1 : 135 (mm)
OD 1 : 93 (mm)
Thread Size : 1-14 UNS-2B
Gasket Type : Square

CONT : 12
VOL : 0.022

SFA F700S Air Filter Secondary Metal End Cap Element
MERCEDES-BENZ 002 094 33 04
INTERNATIONAL HARVESTER 3147878R1
KUBOTA 35873-11181
DEUTZ 4144897



Primary Filter uses SFA 1089P
Set Filter uses SFA 1089SET
H 1 : 326 (mm)
OD 1 : 78 (mm)
OD 2 : 68 (mm)
ID 1 : 58 (mm)
ID 2 : 18 (mm)

CONT : 25
VOL : 0.107

SFF 0453 Fuel Filter Metal End Cap Element
MERCEDES-BENZ 1457431261
IVECO 190605
DAEWOO 65.12503-5003



H 1 : 113 (mm)
H 2 : 107 (mm)
OD 1 : 64 (mm)
OD 2 : 64 (mm)
ID 1 : 12.8 (mm)
ID 2 : 12.8 (mm)

CONT : 50
VOL : 0.033

SFF 105N Fuel Filter Spin-On
CUMMINS 154709
CUMMINS 3315844



H 1 : 136 (mm)
OD 1 : 93 (mm)
Thread Size : 1-14 UNS-2B

CONT : 12
VOL : 0.022

Note : Is a short version of SFF 0213

SFF 0006 Fuel Filter Metal End Cap Element
VOLVO 11712889
DEUTZ 134 0114
ATLAS COPCO 2900 0520
LIEBHERR 702 12 65
FAUN 99701425903



H 1 : 120 (mm)
H 2 : 104 (mm)
OD 1 : 84.5 (mm)
OD 2 : 84.5 (mm)
ID 1 : 12.8 (mm)
ID 2 : 12.8 (mm)

CONT : 50
VOL : 0.059

SFF 0511 Fuel Filter Secondary Metal End Cap Element
EUCLID 5573261



H 1 : 93 (mm)
H 2 : 83 (mm)
OD 1 : 74 (mm)
OD 2 : 74 (mm)
ID 1 : 26 (mm)
ID 2 : 26 (mm)

CONT : 50
VOL : 0.036

SFF 1723 Fuel Filter Spin-On
LOMBARDINI 276-2175-046
VOLVO 7243004-4



H 1 : 122 (mm)
OD 1 : 76 (mm)
Thread Size : M16X1.5-6H
Gasket Type : Square

CONT : 50
VOL : 0.050

Note : HIGH PERFORMANCE VERSION USES SFF 5167

SFF 0105D Fuel Filter Spin-On
MITSUBISHI 32540-20300
MITSUBISHI 32562-20300
HITACHI 4085912



H 1 : 175 (mm)
OD 1 : 93 (mm)
Thread Size : 1-14 UNS-2B
Thread Nut Size : M8X1.25
Gasket Type : Square

CONT : 12
VOL : 0.028

SFF 0723 Fuel Filter Spin-On
VOLVO 241672
VOLVO 243004
MASSEY-FERGUSON 2871513M1



H 1 : 123 (mm)
OD 1 : 76 (mm)
Thread Size : M16X1.5-6H
Gasket Type : Square

CONT : 50
VOL : 0.048

Note : With Center Tube

SFF 3045 Fuel Filter Spin-On
DEUTZ 0118 2671
DEUTZ 0118 2673
LIEBHERR 10412130
VOLVO 17224161
CATERPILLAR 399-1442



H 1 : 143 (mm)
OD 1 : 93 (mm)
Thread Size : M18X1.5-6H
Gasket Type : Square

CONT : 12
VOL : 0.022

SFF 0402 Fuel Filter Metal End Cap Element
DAEWOO 65125035001
CASE 714401R92
CLAAS 99104



H 1 : 112 (mm)
H 2 : 102 (mm)
OD 1 : 69 (mm)
OD 2 : 69 (mm)
ID 1 : 19 (mm)
ID 2 : 19 (mm)

CONT : 50
VOL : 0.034

SFF 0860 Fuel Filter Metal End Cap Element With Felt Media
MERCEDES-BENZ 352 470 00 92



H 1 : 101.5 (mm)
OD 1 : 64 (mm)
OD 2 : 64 (mm)
ID 1 : 13 (mm)
ID 2 : 13 (mm)

CONT : 50
VOL : 0.033

SFF 3291 Fuel Filter Spin-On
KHD(KLOCKNER-HUMBOLT-DEUTZ) 1174482
J.C.BAMFORD 32/912001



H 1 : 163 (mm)
OD 1 : 81.5 (mm)
Thread Size : M16X1.5-6H
Thread Nut Size : M8X1.25
Gasket Type : Square

CONT : 25
VOL : 0.038



Product Guide

SFF 3811 Fuel Filter Primary Metal End Cap Element
MERCEDES-BENZ 000 477 31 15



CONT : 50
VOL : 0.063

H 1 : 145 (mm)
H 2 : 130 (mm)
OD 1 : 84.5 (mm)
OD 2 : 84.5 (mm)
ID 1 : 13 (mm)
ID 2 : 13 (mm)

SFF 5427 Fuel Filter Spin-On
LIEBHERR 738204523



CONT : 12
VOL : 0.022

H 1 : 140 (mm)
OD 1 : 93 (mm)
Thread Size : M16X1.5-6H

SFF 900X Fuel Filter Metal End Cap Element
MERCEDES-BENZ 000 090 14 51
MERCEDES-BENZ 422 092 00 05
MERCEDES-BENZ A 000 090 14 51



CONT : 25
VOL : 0.038

H 1 : 145 (mm)
H 2 : 130 (mm)
OD 1 : 84.5 (mm)
OD 2 : 84.5 (mm)
ID 1 : 13 (mm)
ID 2 : 13 (mm)

SFF 4060E Fuel Filter Eco Element
LIEBHERR 10149977



CONT : 12
VOL : 0.057

H 1 : 238.5 (mm)
H 2 : 185.5 (mm)
OD 1 : 95 (mm)
OD 2 : 95.5 (mm)
ID 1 : 30.5 (mm)

SFF 5672E Fuel Filter Eco Element High Efficiency
MAN 51.12503.0037



CONT : 25
VOL : 0.046

H 1 : 231 (mm)
H 2 : 203.5 (mm)
OD 1 : 76 (mm)
OD 2 : 76 (mm)
ID 1 : 27.5 (mm)
ID 2 : 11.5 (mm)

SFF 9405 Fuel Filter Spin-On
MERCEDES-BENZ 000 092 83 01
MERCEDES-BENZ 000 092 94 01
DEUTZ 1161003



CONT : 12
VOL : 0.025

H 1 : 140 (mm)
OD 1 : 93 (mm)
Thread Size : M16X1.5-6H

SFF 4474 Fuel Filter Plastic Element
INTERNATIONAL 3004474C91
INTERNATIONAL 3004474C92



CONT : 0
VOL : 0.000

H 1 : 42 (mm)
OD 1 : 50 (mm)
OD 2 : 47 (mm)
ID 1 : 44 (mm)
ID 2 : 24 (mm)

SFF 6915 Fuel Filter Primary Spin-On
GENERAL MOTORS 25014274
GENERAL MOTORS 6438839



Secondary Filter uses SFF 6916

CONT : 12
VOL : 0.028

H 1 : 203 (mm)
OD 1 : 93 (mm)
Thread Size : 1-12 UNF-2B
Gasket Type : Square

SFH 0229 Hydraulic Oil Filter Spin-On
MASSEY-FERGUSON 2754362M1
LIEBHERR 5612546
BOMAG 5821213



CONT : 12
VOL : 0.026

H 1 : 174.4 (mm)
OD 1 : 93 (mm)
Thread Size : 1-12 UNF-2B

SFF 5090E Fuel Filter Eco Element



CONT : 0
VOL : 0.000

H 1 : 209 (mm)
H 2 : 179 (mm)
OD 1 : 122 (mm)
ID 1 : 45 (mm)

SFF 6916 Fuel Filter Secondary Spin-On
GENERAL MOTORS 25010778
GENERAL MOTORS 6438840



Primary Filter uses SFF 6915

CONT : 12
VOL : 0.023

H 1 : 172 (mm)
OD 1 : 93 (mm)
Thread Size : 13/16-12 UNF-2B

SFH 0601 Hydraulic Oil Filter Metal End Cap Element With Microfiber media
LIEBHERR 10037616
CATERPILLAR 311935
LIEBHERR 5705816
SANY B222100000445



CONT : 50
VOL : 0.016

H 1 : 83 (mm)
H 2 : 78.5 (mm)
OD 1 : 45 (mm)
OD 2 : 45 (mm)
ID 1 : 21 (mm)

SFF 5220 Fuel Filter Metal End Cap Element
EUCLID 5574961
GENERAL MOTORS 5574961



CONT : 50
VOL : 0.053

H 1 : 139 (mm)
H 2 : 134 (mm)
OD 1 : 74 (mm)
OD 2 : 74 (mm)
ID 1 : 26 (mm)
ID 2 : 26 (mm)

SFF 7122 Fuel Filter Spin-On
DEUTZ 1174424
CROSLAND 5003



CONT : 50
VOL : 0.034

H 1 : 79 (mm)
OD 1 : 76 (mm)
Thread Size : M16X1.5-6H

Note : With Center Tube

SFH 0962 Hydraulic Oil Filter Spin-On
LOESING 025105
MASSEY-FERGUSON 2979653M1
VOLVO 4787923
INGERSOLL RAND 54672654



CONT : 12
VOL : 0.031

H 1 : 200 (mm)
OD 1 : 93 (mm)
Thread Size : 1-12 UNF-2B
BPV (kg/cm2) : YES
Gasket Type : Square



Product Guide

SFH 101X Hydraulic Oil Filter Transmission Metal End Cap Element

MERCEDES-BENZ 000 270 10 98
ZF 0501 203 018
ZF 0750 131 003



H 1 : 104 (mm)
H 2 : 97 (mm)
OD 1 : 68.6 (mm)
OD 2 : 68.6 (mm)
ID 1 : 33 (mm)

CONT : 50
VOL : 0.037

SFH 3490 Hydraulic Oil Filter Metal End Cap Element with synthetic media

LIEBHERR 736 0470



H 1 : 460 (mm)
OD 1 : 100 (mm)
OD 2 : 100 (mm)
ID 1 : 63 (mm)
ID 2 : 63 (mm)

CONT : 6
VOL : 0.040

SFH 6389 Hydraulic Oil Filter Transmission Metal End Cap Element Synthetic Media

VOLVO 11992372
ALLISON 23040988
GENERAL MOTORS 23040988



H 1 : 208 (mm)
H 2 : 204 (mm)
OD 1 : 76.5 (mm)
OD 2 : 76.5 (mm)
ID 1 : 38 (mm)

CONT : 12
VOL : 0.028

SFH 1534 Hydraulic Oil Filter Metal End Cap Element

LOESING 140035
TEREX 5620129
TIMBERJACK 894423
BOMAG 96009814



H 1 : 134.5 (mm)
H 2 : 129 (mm)
OD 1 : 70 (mm)
OD 2 : 70 (mm)
ID 1 : 29 (mm)
ID 2 : 13 (mm)

CONT : 25
VOL : 0.028

SFH 3884 Hydraulic Oil Filter Metal End Cap Element

LIEBHERR 7368875
LIEBHERR 7373884



H 1 : 950 (mm)
H 2 : 940 (mm)
OD 1 : 152 (mm)
OD 2 : 155 (mm)
ID 1 : 80.5 (mm)
ID 2 : 99.5 (mm)

CONT : 1
VOL : 0.029

SFH 6614 Hydraulic Oil Filter Metal End Cap Element

HYDAC 660D010BHHC



H 1 : 329.5 (mm)
H 2 : 325 (mm)
OD 1 : 91.5 (mm)
ID 1 : 46.5 (mm)

CONT : 0
VOL : 0.000

SFH 1573 Hydraulic Oil Filter Metal End Cap Element

LOESING 140061
LIEBHERR 510669708



H 1 : 356 (mm)
H 2 : 250 (mm)
OD 1 : 130 (mm)
OD 2 : 130 (mm)
ID 1 : 63 (mm)

CONT : 9
VOL : 0.079

SFH 4368 Hydraulic Oil Filter Metal End Cap Element

LIEBHERR 736 4368



H 1 : 213 (mm)
H 2 : 167 (mm)
OD 1 : 81.5 (mm)
OD 2 : 71 (mm)
ID 1 : 40 (mm)

CONT : 9
VOL : 0.019

SFH 6680 Hydraulic Oil Filter Metal End Cap Element Synthetic Media

HYDAC 0330D010BN3HC



H 1 : 164 (mm)
H 2 : 157 (mm)
OD 1 : 90 (mm)
OD 2 : 90.5 (mm)
ID 1 : 47 (mm)

CONT : 50
VOL : 0.000

SFH 2910 Hydraulic Oil Filter Metal End Cap Element With Microfiber media

CATERPILLAR 109-7293
LIEBHERR 736 2910



H 1 : 94.5 (mm)
H 2 : 92 (mm)
OD 1 : 35 (mm)
OD 2 : 35 (mm)
ID 1 : 11.5 (mm)

CONT : 100
VOL : 0.019

SFH 4729 Hydraulic Oil Filter Transmission Spin-On With Microfiber media

J.C.BAMFORD 32925905
ZF 501323154
CASE 8603535
CASE 87519452
JOHN DEERE AT336140



H 1 : 199 (mm)
OD 1 : 94.5 (mm)
Thread Size : 1 3/8-12 UNF-2B
Thread Stud Size : M24X1.5-6H
Gasket Type : Square

CONT : 12
VOL : 0.030

SFH 6837 Hydraulic Oil Filter Transmission Spin-On

LIUGONG 0750131053ZE
HITACHI 4230376
HITACHI 4286837
KOMATSU BW252116



H 1 : 200 (mm)
OD 1 : 93 (mm)
Thread Size : 1-12 UNF-2B
Thread Nut Size : M24X1.5
BPV (kg/cm2) : 2.5
Gasket Type : Square

CONT : 12
VOL : 0.034

SFH 3055 Hydraulic Oil Filter Metal End Cap Element

CATERPILLAR 312140
JOHN DEERE 841334500



H 1 : 291 (mm)
OD 1 : 126 (mm)
OD 2 : 126 (mm)
ID 1 : 91.6 (mm)
ID 2 : 9 (mm)

CONT : 9
VOL : 0.062

Note : SFH 8414(Media difference)

SFH 6359 Hydraulic Oil Filter Spin-On Cellulose media

CASE 1966553C1



H 1 : 226 (mm)
OD 1 : 127 (mm)
Thread Size : 1 1/4 BSP
Gasket Type : Square

CONT : 6
VOL : 0.031

Note : 35 micron

SFH 7243 Hydraulic Oil Filter Full Flow Spin-On

LINDE 000.983.06.01



H 1 : 138 (mm)
OD 1 : 76 (mm)
Thread Size : 3/4-16 UNF-2B
BPV (kg/cm2) : 3.3 - 3.7

CONT : 36
VOL : 0.039



Product Guide

SFH 7524 Hydraulic Oil Filter Metal End Cap Element
 MANITOU 737524
 JOHN DEERE FO58437



H 1 : 129 (mm)
 H 2 : 123 (mm)
 OD 1 : 68.6 (mm)
 OD 2 : 68.6 (mm)
 ID 1 : 33 (mm)

CONT : 25
 VOL : 0.023

SFO 0947 Oil Filter Full Flow Spin-On
 GENERAL MOTORS 23518667
 GENERAL MOTORS 25011106
 CATERPILLAR 3I-1223



H 1 : 159 (mm)
 OD 1 : 121 (mm)
 Thread Size : 1 1/2-12 UNF-2B
 Gasket Type : Square

CONT : 6
 VOL : 0.024

SFO 2107 Oil Filter Full Flow Metal End Cap Element
 MERCEDES-BENZ 000 184 40 25



H 1 : 195 (mm)
 OD 1 : 114 (mm)
 OD 2 : 114 (mm)
 ID 1 : 58.5 (mm)
 ID 2 : 58.5 (mm)

CONT : 12
 VOL : 0.038

Note : to upgrade use SFO 9809

SFH 7601 Hydraulic Oil Filter Spin-On
 DEUTZ 1173481
 NISSAN 58396-47601



H 1 : 135 (mm)
 OD 1 : 93 (mm)
 Thread Size : 1-12 UNF-2B
 BPV (kg/cm2) : 1.4 - 1.6
 ADBV : YES
 Gasket Type : Round

CONT : 25
 VOL : 0.044

SFO 0950 Oil Filter Full Flow Spin-On
 IVECO 1161934
 IVECO 1902136



H 1 : 169 (mm)
 OD 1 : 93 (mm)
 Thread Size : 1-12 UNF-2B
 BPV (kg/cm2) : 1.0

CONT : 12
 VOL : 0.027

SFO 2110 Oil Filter Full Flow Metal End Cap Element
 MERCEDES-BENZ 000 184 04 25
 MERCEDES-BENZ 001 184 04 25
 MERCEDES-BENZ 401 180 0009

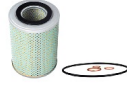

H 1 : 193 (mm)
 H 2 : 165.5 (mm)
 OD 1 : 121 (mm)
 OD 2 : 121 (mm)
 ID 1 : 56 (mm)
 ID 2 : 14 (mm)

CONT : 32
 VOL : 0.122

Note : Paper Protector, Spring

SFO 0132 Oil Filter Full Flow Metal End Cap Element
 GENERAL MOTORS 357304
 GENERAL MOTORS 5573014
 GENERAL MOTORS 5573102



H 1 : 231 (mm)
 H 2 : 227 (mm)
 OD 1 : 109 (mm)
 OD 2 : 109 (mm)
 ID 1 : 37 (mm)
 ID 2 : 37 (mm)

CONT : 12
 VOL : 0.043

Note : Metal Protector

SFO 1034 Oil Filter Full Flow Metal End Cap Element
 MERCEDES-BENZ 001 184 43 25



H 1 : 195 (mm)
 OD 1 : 83.5 (mm)
 OD 2 : 83.5 (mm)
 ID 1 : 24.5 (mm)
 ID 2 : 24.5 (mm)

CONT : 25
 VOL : 0.069

Note : Paper Protector

SFO 2300 Oil Filter Combination Spin-On Synthetic Media
 KOMATSU 6742-01-4120



H 1 : 280 (mm)
 OD 1 : 121 (mm)
 Thread Size : 2 1/4-12 UNF-2B
 Gasket Type : Square

CONT : 6
 VOL : 0.031

SFO 0516 Oil Filter Full Flow Metal End Cap Element
 CUMMINS 158139
 KOMATSU 6610-51-5100
 KOMATSU CULF-516



H 1 : 249 (mm)
 H 2 : 244.9 (mm)
 OD 1 : 126 (mm)
 OD 2 : 126 (mm)
 ID 1 : 39 (mm)
 ID 2 : 39 (mm)

CONT : 9
 VOL : 0.054

Note : Paper Protector

SFO 1076 Oil Filter Full Flow Metal End Cap Element
 MERCEDES-BENZ 001 184 56 25
 CROSLAND 1001
 MERCEDES-BENZ 355 180 01 09



H 1 : 243 (mm)
 H 2 : 235 (mm)
 OD 1 : 97 (mm)
 OD 2 : 97 (mm)
 ID 1 : 42 (mm)
 ID 2 : 13 (mm)

CONT : 25
 VOL : 0.083

Note : Paper Protector

SFO 2670 Oil Filter Full Flow Spin-On Cellulose media
 CUMMINS 3313279
 MITSUBISHI 37540-01101
 CUMMINS 3889310
 KOMATSU CULF-670



H 1 : 246 (mm)
 OD 1 : 118 (mm)
 Thread Size : 1 1/2-12 UNF-2B
 Gasket Type : Square

CONT : 12
 VOL : 0.056

SFO 0754 Oil Filter Full Flow Spin-On
 INGERSOLL RAND 36881696



H 1 : 140 (mm)
 H 2 : 145 (mm)
 OD 1 : 94 (mm)
 Thread Size : 1 1/2-16 UN-2B
 BPV (kg/cm2) : YES
 Gasket Type : Square

CONT : 12
 VOL : 0.022

SFO 1705 Oil Filter Full Flow Spin-On
 LIEBHERR 11990
 LIEBHERR 738 1111



H 1 : 225 (mm)
 OD 1 : 108 (mm)
 Thread Size : M30X2-6H
 ADBV : YES
 Gasket Type : Square

CONT : 12
 VOL : 0.044

Note : delivered without removal nut

SFO 2777 Oil Filter By Pass Spin-On
 ISUZU 1-87310093-0
 CATERPILLAR 1W-8845
 J.C.BAMFORD 32/919502
 HITACHI 4285964

















H 1 : 246.5 (mm)
 OD 1 : 115 (mm)
 Thread Size : 1 3/8-16 UN-2B
 Gasket Type : Square

CONT : 12
 VOL : 0.056

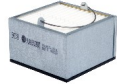

Product Guide

<p>SFO 3327</p>  <p>CONT : 16 VOL : 0.078</p> <p>Note : Paper Protector, Spring</p>	<p>Oil Filter Full Flow Metal End Cap Element</p> <p>MERCEDES-BENZ 000 184 38 25 MERCEDES-BENZ 1457429740 MERCEDES-BENZ 402 180 00 09</p> <p>H 1 : 269.5 (mm) H 2 : 242 (mm) OD 1 : 121 (mm) OD 2 : 121 (mm) ID 1 : 56 (mm) ID 2 : 14 (mm)</p>	<p>SFO 7124</p>  <p>CONT : 50 VOL : 0.036</p>	<p>Oil Filter Full Flow Spin-On</p> <p>AUDI (SEE V.W) 035 115 591 VW GROUP 035 115 591 DEUTZ 1174416 KHD(KLOCKNER-HUMBOLT-DEUTZ) 1174416 VW V0 5000280</p> <p>H 1 : 90 (mm) OD 1 : 76 (mm) Thread Size : 3/4-16 UNF-2B BPV (kg/cm2) : 2.0 - 2.5 ADBV : YES Gasket Type : Square</p>	<p>SFO 9471</p>  <p>CONT : 25 VOL : 0.069</p> <p>Note : Hanger, Paper Protector</p>	<p>Oil Filter Full Flow Metal End Cap Element</p> <p>MERCEDES-BENZ 001 184 42 25 MERCEDES-BENZ 001 184 52 25 MERCEDES-BENZ 1414</p> <p>H 1 : 195 (mm) H 2 : 190 (mm) OD 1 : 83 (mm) OD 2 : 83 (mm) ID 1 : 25 (mm) ID 2 : 25 (mm)</p>
<p>SFO 4018</p>  <p>CONT : 12 VOL : 0.020</p> <p>Note : Without Nut</p>	<p>Oil Filter Full Flow Spin-On</p> <p>DEMAG 206 089 40 RENAULT 60 05 024 443</p> <p>H 1 : 140 (mm) OD 1 : 93 (mm) Thread Size : 1-12 UNF-2B BPV (kg/cm2) : 1.0</p>	<p>SFO 7195</p>  <p>CONT : 50 VOL : 0.048</p>	<p>Oil Filter Full Flow Spin-On</p> <p>VW GROUP 070 115 561 NISSAN 15208-V4000 FORD (EUROPE) 5003 460</p> <p>H 1 : 120 (mm) OD 1 : 76 (mm) Thread Size : 3/4-16 UNF-2B BPV (kg/cm2) : 2.0 - 2.5 ADBV : YES Gasket Type : Square</p>	<p>SFO 9471E</p>  <p>CONT : 12 VOL : 0.035</p>	<p>Oil Filter Full Flow Eco Element with adhesive</p> <p>MERCEDES-BENZ 001 184 42 25 MERCEDES-BENZ 001 184 43 25 MERCEDES-BENZ 001 184 52 25</p> <p>H 1 : 198 (mm) H 2 : 192 (mm) OD 1 : 84 (mm) OD 2 : 84 (mm) ID 1 : 23.25 (mm) ID 2 : 23.25 (mm)</p>
<p>SFO 4054</p>  <p>CONT : 12 VOL : 0.028</p> <p>Note : With Grip</p>	<p>Oil Filter Full Flow Spin-On</p> <p>MERCEDES-BENZ 001 184 96 01 DEUTZ 116004 KHD(KLOCKNER-HUMBOLT-DEUTZ) 117 4421 DEUTZ 1173430</p> <p>H 1 : 206 (mm) OD 1 : 93 (mm) Thread Size : 1-12 UNF-2B BPV (kg/cm2) : 2.0 - 2.5 ADBV : YES Gasket Type : Square</p>	<p>SFO 7295</p>  <p>CONT : 12 VOL : 0.046</p>	<p>Oil Filter Full Flow Spin-On</p> <p>LIEBHERR 10297295</p> <p>H 1 : 237 (mm) OD 1 : 108 (mm) Thread Size : M30X2-6H ADBV : YES Gasket Type : Square</p>	<p>SFO 9627</p>  <p>CONT : 12 VOL : 0.028</p> <p>Note : With double anti-drainback valve</p>	<p>Oil Filter Full Flow Spin-On</p> <p>LIEBHERR 5700043 LIEBHERR 570004323</p> <p>H 1 : 214 (mm) OD 1 : 93 (mm) Thread Size : 1-12 UNF-2B BPV (kg/cm2) : 1.0 ADBV : YES Gasket Type : Square</p>
<p>SFO 5050</p>  <p>CONT : 6 VOL : 0.111</p>	<p>Oil Filter By Pass Can-type Depth</p> <p>KOMATSU 6610-51-5050</p> <p>H 1 : 382 (mm) H 2 : 376 (mm) OD 1 : 197 (mm) OD 2 : 197 (mm) ID 1 : 22 (mm) ID 2 : 22 (mm)</p>	<p>SFO 8551E</p>  <p>CONT : 12 VOL : 0.025</p>	<p>Oil Filter Full Flow Eco Element</p> <p>LINDE 000 983 1637 VOLVO 11708551 DEUTZ 293 1095</p> <p>H 1 : 213 (mm) H 2 : 199 (mm) OD 1 : 83 (mm) OD 2 : 83 (mm) ID 1 : 37 (mm) ID 2 : 9 (mm)</p>	<p>SFR 0103FW</p>  <p>CONT : 50 VOL : 0.039</p>	<p>Fuel/Water Separator Metal framed Element</p> <p>SEPAR 1030 CASE 87409379</p> <p>H 1 : 51 (mm) Length 1 : 88 (mm) Width 1 : 88 (mm)</p>
<p>SFO 5565</p>  <p>CONT : 12 VOL : 0.050</p>	<p>Oil Filter By Pass Spin-On</p> <p>VOLVO 477556 VOLVO 477556-5</p> <p>H 1 : 259 (mm) OD 1 : 108 (mm) Thread Size : 1 3/8-16 UNF-2B Gasket Type : Square</p>	<p>SFO 9214</p>  <p>CONT : 6 VOL : 0.026</p>	<p>Oil Filter Full Flow Spin-On</p> <p>DEUTZ 1174420 FIAT 1174420 CROSLAND 2038</p> <p>H 1 : 259 (mm) OD 1 : 108 (mm) Thread Size : 1 1/8-16 UNF-2B BPV (kg/cm2) : YES Gasket Type : Square</p>	<p>SFR 0420FW</p>  <p>CONT : 25 VOL : 0.034</p> <p>Note : 10 micron, standard flow</p>	<p>Fuel/Water Separator Spin-On With Drain</p> <p>INGERSOLL RAND 85400976 JOHN DEERE RE60021</p> <p>H 1 : 112 (mm) H 2 : 90 (mm) OD 1 : 80 (mm) ID 1 : 17 (mm)</p>



To order, please call:
+1 8448 BE SURE; +1 (925) 566-8863

FOR REFERENCE ONLY - REPRESENTATIVE PICTURE ONLY



Email :
order@surefilter.us



Product Guide

SFR 0901FW Fuel/Water Separator Secondary Spin-On 10 Micron

MERCEDES-BENZ 000 477 1602
VOLVO 20788794
HYUNDAI 31945-87000
RENAULT 7 420 745 605
MERCEDES-BENZ A 000 477 16 02



H 1 : 158 (mm)
OD 1 : 108 (mm)
Thread Size : 1-14 UNS-2B

CONT : 12
VOL : 0.033

Note : bowl not included

SFR 2242FW Fuel/Water Separator Secondary Spin-On 10 Micron

MASSEY-FERGUSON 108615W1
RENAULT 5006002224
NEW HOLLAND (CNH) 87413717
SANY A22210000399
KOBELCO YN02PU1010P1



H 1 : 156 (mm)
OD 1 : 95 (mm)
Thread Size : 1-14 UNS-2B
Thread Nut Size : 1 1/4-10 UNS-2B
Gasket Type : Square

CONT : 12
VOL : 0.025

Note : bowl not included

SFR 9001FWB Fuel/Water Separator Spin-On With Bowl 10 Micron

MERCEDES-BENZ R90-MER-01



H 1 : 308 (mm)
OD 1 : 108 (mm)
Thread Size : 1-14 UNS-2B

CONT : 12
VOL : 0.059

Note : SFR 9001FW and SB 308Y

SFR 0901FWB Fuel/Water Separator Secondary Spin-On With Bowl 10 Micron

MERCEDES-BENZ 000 477 1602
VOLVO 20788794
HYUNDAI 31945-87000
RENAULT 7 420 745 605



H 1 : 253 (mm)
OD 1 : 108 (mm)
Thread Size : 1-14 UNS-2B

CONT : 12
VOL : 0.048

Note : SFR 0901FW and SB 308Y

SFR 4302FW Fuel/Water Separator Spin-On High Efficiency

LIEBHERR 10044303



H 1 : 147 (mm)
OD 1 : 108 (mm)
Thread Size : 1-14 UNS-2B
Gasket Type : Square

CONT : 12
VOL : 0.030

Note : 2 micron

SFR 90T1FW Fuel/Water Separator Spin-On 10 Micron

VOLVO 20450423
KING LONG 211200010
HINO 23390-E0010
HINO 23401-1700
ATLAS COPCO 2914-8071-00



H 1 : 155 (mm)
H 2 : 158 (mm)
OD 1 : 108 (mm)
Thread Size : 1-14 UNF-2B
Thread Nut Size : 3 3/4-10 UNS-2A
Gasket Type : Square

CONT : 12
VOL : 0.031

SFR 1212FW Fuel/Water Separator Spin-On

ISUZU 1-13240044-1
CUMMINS 3308638
CUMMINS 3315843
SUNWARD 750201011130



H 1 : 174 (mm)
OD 1 : 93 (mm)
Thread Size : 1-14 UNS-2B
Thread Size : M14X2.0
Gasket Type : Square

CONT : 12
VOL : 0.031

SFR 44301FW Fuel/Water Separator Spin-On 10 Micron

LUBER-FINER 10044302



H 1 : 159 (mm)
H 2 : 143.5 (mm)
OD 1 : 108 (mm)
Thread Size : 1-14 UNS-2B
Gasket Type : Square

CONT : 12
VOL : 0.036

Note : SFR 90T1FW(bottom plate difference)

SFR 90T1FWB Fuel/Water Separator Spin-On 10 Micron

VOLVO 20450423
HINO 23390-E0010
HINO 23401-1700
GENERAL MOTORS 23514654
ATLAS COPCO 2914-8071-00



H 1 : 216.5 (mm)
OD 1 : 108 (mm)
Thread Size : 1-14 UNF-2B
Thread Nut Size : 3 3/4-10 UNS-2A
Gasket Type : Square

CONT : 12
VOL : 0.044

SFR 1216FW Fuel/Water Separator Spin-On With Drain

CUMMINS 3309437
CUMMINS 3313304
HITACHI 4202934



H 1 : 311.4 (mm)
OD 1 : 115.5 (mm)
Thread Size : 1 1/4-12 UNF-2B
Gasket Type : Square

CONT : 6
VOL : 0.036

Note : Drain Plug

SFR 5110FW Fuel/Water Separator Spin-On 10 Micron

CATERPILLAR 256-8753
CUMMINS 3329289
HITACHI 4377880
SANY B22210000596



H 1 : 245 (mm)
OD 1 : 93 (mm)
Thread Size : 1-14 UNS-2B
Gasket Type : Square

CONT : 6
VOL : 0.018

SFW 2071 Coolant Filter Spin-On

CUMMINS 299080
CUMMINS 3100304
CUMMINS 3305367



H 1 : 100 (mm)
OD 1 : 93 (mm)
Thread Size : 11/16-16 UNF-2B
Gasket Type : Square

CONT : 12
VOL : 0.014

Note : Coolants 4 units

SFR 1422FW Fuel/Water Separator Spin-On With Drain High Efficiency

INGERSOLL RAND 23018955
JOHN DEERE RE22878
JOHN DEERE RE509032
JOHN DEERE RE522878



H 1 : 197.4 (mm)
H 2 : 172 (mm)
OD 1 : 80 (mm)
ID 1 : 17 (mm)

CONT : 25
VOL : 0.044

Note : 2 micron, standard flow

SFR 9001FW Fuel/Water Separator Spin-On 10 Micron

MERCEDES-BENZ 000 470 04 69
MERCEDES-BENZ A 000 470 04 69
MERCEDES-BENZ R90-MER-01



H 1 : 217 (mm)
OD 1 : 108 (mm)
Thread Size : 1-14 UNS-2B
Gasket Type : Square

CONT : 6
VOL : 0.043

Note : bowl not included

SFW 2072 Coolant Filter Spin-On

KOMATSU 600-411-1140
KOMATSU 600-411-1191



H 1 : 100 (mm)
OD 1 : 93 (mm)
Thread Size : 11/16-16 UNF-2B
Gasket Type : Square

CONT : 12
VOL : 0.016

Note : Coolants = 6 units



Product Guide

SFW 2073

Coolant Filter Spin-On

CUMMINS 3315115
CUMMINS 3316462
CUMMINS 4058964



H 1 : 100 (mm)
OD 1 : 93 (mm)
Thread Size : 11/16-16 UNF-2B
Gasket Type : Square

CONT : 12
VOL : 0.017

Note : Coolants = 8 units

SFW 2075

Coolant Filter Spin-On

HITACHI 4228689
INGERSOLL RAND 57165805



H 1 : 136 (mm)
OD 1 : 93 (mm)
Thread Size : 11/16-16 UNF-2B
Gasket Type : Square

CONT : 12
VOL : 0.021

Note : coolant=15 units

SFW 2076

Coolant Filter Spin-On

CUMMINS 3318319
HITACHI 4266063



H 1 : 136 (mm)
OD 1 : 93 (mm)
Thread Size : 11/16-16 UNF-2B
Gasket Type : Square

CONT : 12
VOL : 0.022

Note : Coolants = 23 units

SFW 4685

Coolant Filter Spin-On

LIEBHERR 7025830



H 1 : 136 (mm)
OD 1 : 93 (mm)
Thread Size : 11/16-16 UNF-2B
Gasket Type : Square

CONT : 12
VOL : 0.021

Note : Without Chemicals



To order, please call:
+1 8448 BE SURE; +1 (925) 566-8863

FOR REFERENCE ONLY - REPRESENTATIVE PICTURE ONLY



Email :
order@surefilter.us